

HO.RE.CA. 2018

abert[®]

abert[®]

Abert nasce nel 1929 a Lumezzane, in provincia di Brescia: Antonio Bertoli dà inizio alla sua storia producendo artigianalmente posate in ottone. Negli anni '30 le materie prime utilizzate sono nichel e alluminio e nel 1950 l'acciaio entra stabilmente nei cicli di produzione, prendendo il posto di tutti gli altri materiali. Negli anni '60 verrà introdotta l'automatizzazione produttiva e nel 1975 Abert sarà la prima azienda al mondo ad ingegnerizzare i processi per la produzione di posate colorate con la combinazione di materiali come ABS, nylon e legno. Nel 1987 la sede si trasferisce a Passirano e nel 1993 acquisisce il marchio Facix e lo storico marchio milanese Broggi, leader di mercato nella posateria e nei complementi d'arredo per la tavola nel settore alberghiero. Nel 1994 è la prima azienda del settore ad ottenere la certificazione di qualità ISO 9002. Nel 2000 Abert cresce lanciando un nuovo progetto per il canale l'Ho.Re.Ca. con l'introduzione di una ampia gamma di prodotti professionali alberghieri.

Oggi, quasi novant'anni dopo la sua nascita, ancora guidata dalla famiglia Bertoli alla quarta generazione, Abert continua a puntare sull'innovazione, sulla qualità dei propri prodotti, sulla sensibilità e l'ascolto del cliente e sulla sua capacità di mutare insieme al mercato.

Abert pone da sempre al centro della propria attività valori che considera irrinunciabili: l'eccellenza delle materie prime, determinante per la performance dei propri prodotti, l'innovazione sulla base di processi produttivi e tecnologie d'avanguardia, la qualità dei prodotti che produce nei propri stabilimenti, a Passirano, il design che si traduce nella creazione di oggetti unici e che è alla base dello studio di ogni suo nuovo prodotto.

Per vincere le sfide del futuro Abert investe su se stessa e sui propri valori, che esprime con una forte cultura d'impresa ed azioni concrete, impegnandosi nella tutela e nella difesa dell'ambiente e nell'etica dei rapporti economici e sociali.

STORIA • HISTORY

Abert is founded in 1929 in Lumezzane, in the province of Brescia: Antonio Bertoli starts its story by manufacturing brass cutlery by hand. in the 30's the raw materials used are nickel and aluminium and in 1950 steel enters in the production cycles permanently, replacing all the other materials. in the '60s production automation is introduced and in 1975 Abert is the first company in the world to engineering the processes for the production of colored-handle cutlery with the combination of materials like ABS, nylon and wood. in 1987 the company headquarters move to Passirano and in 1993 Abert acquires the brand Facix and the historical Milanese brand Broggi, market leader in hotel cutlery and tableware. in 1994 it is the first company of the sector to achieve the quality certification ISO 9002. in 2000 Abert grows and launches a new project for the Ho.Re.Ca. channel with the introduction of a wide range of hotel professional products.

Today, almost ninety years after its birth, still led by the Bertoli family on its fourth generation, Abert goes on aiming at innovation, quality of its products, sensitivity and listening to its customers and on its capability of changing with the market.

Abert has always placed at the centre of its activities fundamental values: excellence of raw materials, crucial for the performance of its products, innovation on the base of production processes and state-of-the-art technologies, quality of the products it manufactures in its own factories in Passirano, design, that means creation of unique objects and which is the foundation of every new product.

in order to win the challenges of the future Abert invests on its own and on its values that expresses through a strong enterprise culture and concrete action, committing to protect and defend the environment and the ethics involved in economic and social relationships.

abert[®]

CATALOGO HORECA 2018

POSATE / FLATWARE 5

MODERN	10
CLASSIC	45
BASIC	64
COLOR	80
FINISHING	82

ACCESSORI / ACCESSORIES 93

BREAK&FAST	94
COFFEE&DRINKS	96
TAPAS&APPETIZERS	100
PIZZA&STEAKS	102
MARISCOS&ESCARGOTS	107
CHEESE	108
SERVING	109

BUFFET 121

URBAN	122
MIX&PLAY	136
SQUARE	148
JAMBEE	164
IMPERIAL	168

TAVOLA / HOLLOWWARE 192

ART&TABLE	194
MENAGE	214
RICAMBI	219
LOUNGE&SERVICE	220
CELSIUS	226

WINE&BAR 231

KITCHEN 242

GASTRONORM	244
MANAGE & SERVING	254

PROMAB 260

KITCHEN	262
HOLLOWWARE	268

Alaska	58	Corona	73	Flair	32	Matisse	36	Pop	42	Splendido	50
Allegra	22	Corsaro	78	Garda Top	45	Med	44	Rada	48	Step	25
Amarcord	11	Cosmos	29	Gourmet	28	Milord	15	Rada Top	48	Style	23
America	79	Dinamica	21	Hermitage	46	Mirage	30	Raffaello	35	Superior	10
Azzurrea	37	Dolce Vita	12	Imperial	49	Monaco	34	Relais	17	Toronto	69
Baguette	54	Dream	13	in & Out	81	Murano	74	Rem	41	Valencia	72
Baltic	33	Ego	18	Infinito	31	N/900 Top	47	Reveil	62	Verve	61
Baltic Abi	82	Elegant	16	Linea	24	Naif	40	Rimini	68	Victory	56
Bella	38	England	59	London	60	New line	80	River	66	Vintage	52
Boston	64	Enrico VIII	57	Luisa	75	Niagara	14	Scozia	63		
Brigitte	39	Ergo	20	Malta	70	Oslo	76	Sef	71		
Brinner	67	Eva	77	Mare	43	Perla	51	Silvia	55		
Condor	53	Firenze	65	Marea	27	Più	26	Slim	19		



POSATE • CUTLERY

MODERN (10)

CLASSIC (45)

BASIC (64)

COLOR (80)

FINISHING (82)

Ciclo di produzione

Il ciclo di produzione di forchette e cucchiai inizia con l'operazione di tranciatura (1). Per diminuire lo spessore della tazza rispetto al manico, si procede poi con la laminazione (2), e si prosegue con la rifilatura (3), per dare la forma della tazza o dei rebbi alla posata laminata. Infine si passa alla coniazione (4), nel corso della quale vengono dati la forma e i decori necessari. Per la lavorazione dei coltelli monoblocco forgiati si parte con la tranciatura del tondino in uno spezzone (1), che viene successivamente coniato a caldo (2), in modo da conferirgli una prima forma. Si prosegue con la tranciatura del manico (3) e con l'allungamento della lama (4); in seguito viene effettuata la tranciatura della lama (5), in modo da darle la forma reale. A questo punto rimane da definire la seghettatura sulla lama (6) e rifinire il coltello con le normali operazioni di pulitura. Le fasi di lavorazione dei coltelli a manico cavo forgiati parte con la tranciatura delle valve (1). Le due valve che costituiranno il manico cavo vengono coniate a freddo (2), per dare loro la convessità e i decori, e poi vengono accoppiate e saldate (3): ecco il manico del coltello. Infine, attraverso un composto autobloccante, viene assemblata e saldata al manico la lama (4), prodotta con le stesse tecniche dei coltelli monoblocco forgiati.

Cutlery manufacturing process

Shearing (1) is the first step in the process of manufacturing forks and spoons. Rolling (2) is used to reduce the bowl thickness compared to that of the handle, and the next step is trimming (3) to give the shape of a bowl or prongs to the laminated implement. The final step is coining (4) during which the implement is shaped and ornamentation stamped. To make forged solid-handle knives the process begins by shearing a bar into a blank (1) that is then hot coined (2) so as to give it some initial shape. Afterwards the handle is sheared (3) and the blade is stretched (4). Then, the blade is sheared (5) so that it takes its final shape. Now blade serration (6) needs to be defined and the knife has to be polished as usual. The first step to make forged hollow-handle knives is shearing the shells (1). The two half-shells that will form the hollow handle are cold-coined (2) to obtain the convexity and stamp the decoration; afterwards the shells are coupled and welded (3). And that is how the knife handle is ready. Finally and by using a self-locking compound the blade, made applying the same techniques used to make forged solid-handle knives, is coupled and welded to the handle (4).

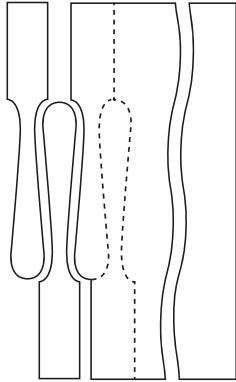

①
Tranciatura
Blank cutting

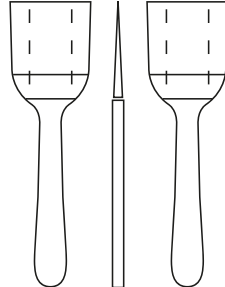

②
Laminazione
Rolling operation

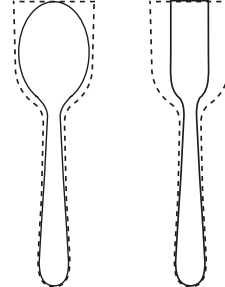

③
Rifilatura
Overall cutting on outside blank

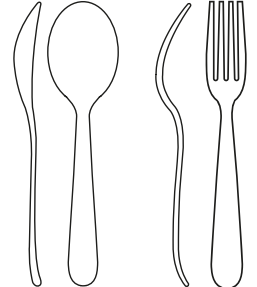

④
Coniatura
Pressing operation

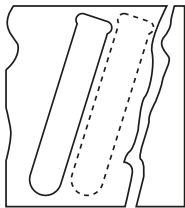

⑤
Tranciatura
Blank cutting



⑥
Coniatura manico
Handle pressing



⑦
Saldatura gocce
Soldering of shells

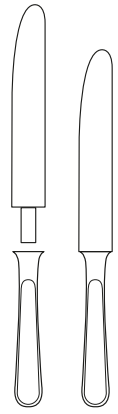

⑧
**Assemblaggio e saldatura
lama manico cavo**
Assembling and soldering
hollow handle knife



⑨
Tranciatura spezzone
Rod cutting

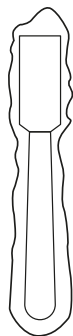

⑩
Coniatura a caldo
Forging

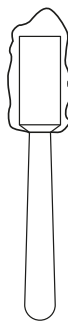

⑪
Tranciatura manico
Blank cutting of the blade

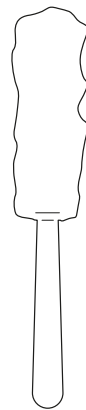

⑫
Laminazione
Rolling of the blade





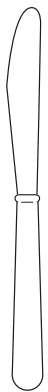















⑬
Ritanciatura lama
2nd blank cutting
of the blade



⑭
Seghettatura e finitura
Blade grinding
and finishing

TABELLA POSATE

01		Cucchiaino tavola Table spoon Cullière de table Eßlöffel Cuchara mesa
02		Forchetta tavola Table fork Fourchette de table Eßgabel Tenedor mesa
03		Cucchiaino brodo Bouillon spoon Cullière à soupe Suppenlöffel Cuchara sopa
04		Coltello tavola forgiato pesante Table knife heavy-forged Couteau de table forgé lourd Tafelmesser-schwer Cuchillo mesa forjado pesado *
05		Coltello tavola forgiato Table knife-forged Couteau de table forgé Tafelmesser Cuchillo mesa forjado *
05R		Coltello tavola Reverse Reverse table knife-forged Couteau de table Reverse Tafelmesser Reverse Cuchillo mesa Reverse forjado *
06		Coltello tavola leggero Table knife-light Couteau de table léger Tafelmesser-leicht Cuchillo mesa ligero *
08		Coltello tavola m/v saldato Table knife - welded hollow-handle Couteau de table poignée creuse soudée Tafelmesser mit Hohlheft Cuchillo mesa mango hueco soldado *
11		Cucchiaino frutta Dessert spoon Cuillère à dessert Dessertlöffel Cuchara postre
12		Forchetta frutta Dessert fork Fourchette à dessert Dessertgabel Tenedor postre
14		Coltello frutta forgiato pesante Dessert knife-heavy forged Couteau à dessert forgé lourd Dessertmesser-schwer Cuchillo postre forjado pesado *
15		Coltello frutta forgiato Dessert knife-forged Couteau à dessert forgé Dessertmesser Cuchillo postre forjado *
15R		Coltello frutta Reverse forgiato Dessert knife forged-Reverse Couteau à dessert Reverse forgé Dessertmesser Reverse Cuchillo postre Reverse forjado *
16		Coltello frutta leggero Dessert knife-light Couteau à dessert léger Dessertmesser-leicht Cuchillo postre ligero *
18		Coltello frutta m/v saldato Dessert knife-welded hollow-handle Couteau à dessert poignée creuse soudée Dessertmesser mit Hohlheft Cuchillo postre mango hueco soldado *
21		Cucchiaino caffè Tea spoon Cuillère à café Kaffeelöffel Cuchara café
22		Cucchiaino moka Moka spoon Cuillère à moka Mokkalöffel Cuchara moka
23		Cucchiaino zucchero Sugar spoon Cuillère à sucre Zuckerlöffel Cuchara azucar
25		Mestolo servire Soup ladle Louche Rührlöffel Cazo sopa
26		Forchettone servire Serving fork Fourchette à servir Vorlegegabel Tenedor servir
27		Cucchiaione servire Serving spoon Cuillère à servir Vorlegelöffel Cucharón servir
28		Cucchiaione insalata Salad serving spoon Cuillère à servir salade Salatlöffel Cucharón servir ensalada
29		Forchettone insalata Salad serving fork Fourchette à servir salade Salatgabel Tenedor servir ensalada
30		Cucchiaione riso Salad serving spoon Cuillère à servir salade Salatlöffel Cucharón servir ensalada
31		Forchetta pesce Fish fork Fourchette à poisson Fischgabel Tenedor pescado
32		Coltello pesce Fish knife Couteau à poisson Fischmesser Cuchillo pescado
33		Forchettone servire pesce Fish serving fork Fourchette à servir poisson Servierfischgabel Tenedor servir pescado
34		Coltello servire pesce Fish serving knife Couteau à servir poisson Servierfischmesser Cuchillo servir pescado
35		Cucchiaino bibita Ice tea spoon Cuillère à cocktail Cocktaillöffel Cuchara refresco
36		Cucchiaino fragola confetto Sweets spoon Cuillère à bonbons Bonbonlöffel Cuchara caramelos
37		Paletta gelato Ice cream spoon Cuillère à glace Speiseeislöffel Cuchara helado
38		Forchettina dolce Cake fork Fourchette à tarte Kuchengabel Tenedor lunch
39		Pala dolce Cake server Pelle à tarte Tortenschaufel Pala pastel
40		Coltellone dolce Cake knife Gros couteau à tarte Tortenmesser Cuchillo pastel
41		Coltellone torta seghettato Cake knife with serrated blade Couteau à tarte lame denteleé Kuchenmesser Cuchillo pastel dentado
42		Mestolino salsa Sauce ladle Louche à sauce Soßeschöpflöffel Cacillo salsa
43		Spalmaburro Butter spreader Couteau à beurre Buttermesser Pala mantequilla
45		Spalmaburro Butter spreader Couteau à beurre Buttermesser Pala mantequilla
53		Spalmaburro forgiato Butter spreader - forged Couteau à beurre forgé Buttermesser Pala mantequilla forjado *
55		Coltello bistecca Steak knife Couteau à bifteck Filetmesser Cuchillo carne *
63		Forchetta lumache 2 punte 2 prongs snail fork Forchette à escargots à deux dents Zweizinkengabel fur Schnecke Tenedor caracoles dos puntas
64		Forchettina ostriche Oyster fork Forchette à crustacés Auster Krustazeengabel Tenero mariscos
67		Cucchiaino salsa Sauce spoon Cuillère à sauce Soßelöffel Cuchara salsa
68		Cucchiaino bimbo Baby spoon Cuillère enfant Kinderlöffel Cuchara niño
69		Forchetta bimbo Baby fork Fourchette enfant Kindergabel Tenedor niño
70		Coltello bimbo Baby knife Couteau enfant Kindermesser Cuchillo niño *
80		Cucchiaino lunch Lunch spoon Cuillère à lunch Lunchlöffel Cuchara lunch

* materiale: acciaio inossidabile | material: stainless steel |
matériel: acier inoxydable | Material: aus Edelstahl | material: acero inoxidable

Istruzioni d'uso e di manutenzione per la posateria e il vasellame in acciaio

Lavare accuratamente i prodotti nuovi Utilizzare per il lavaggio acqua calda ed un buon sapone neutro, risciacquare in seguito con abbondante acqua tiepida ed asciugare scrupolosamente tutti gli articoli. Non utilizzare per il lavaggio detersivi sintetici a base di cloro o prodotti comunque candeggianti. Pomice, paglietta d'acciaio, spugnette o panni impregnati di polveri abrasive devono essere altresì rigorosamente esclusi. Possono invece essere utilizzati detersivi non clorurati contenente farina fossile. E' consigliato il lavaggio degli articoli subito dopo il loro utilizzo. Qualora questo non fosse possibile è comunque importante non lasciare per caso di utilizzo degli articoli a pranzo articoli a cena, andrebbero lavati entro la mattina del giorno seguente). Nel caso fosse necessario un prelavaggio, questo deve essere fatto relativamente breve. Gli articoli non vanno infatti lasciati in ammollo quanto alcune sostanze contenute negli alimenti sono dannose e ne alterano l'aspetto. Le lame dei coltelli prodotte con un pregiato acciaio inossidabile, sono sensibili agli attacchi corrosivi sviluppati dall'acido acetico, citrico, lattico ed in particolare da cloruro di sodio, presenti negli alimenti.

E' importante, sia in fase di prelavaggio che durante il lavaggio, tenere separate le normali posate (cucchiai, forchette, cucchiaini...) dai coltelli e da altri oggetti metallici presenti in cucina.

Nel caso di lavaggio in lavastoviglie le posate devono essere inserite in cestelli verticali di plastica e tenute separate dai coltelli.

Asciugare accuratamente gli articoli con un panno morbido subito dopo il lavaggio, anche se il lavaggio è eseguito in lavastoviglie che prevede un ciclo di asciugatura automatica. Questo è necessario per evitare l'eventuale formazione di macchie dovute a depositi calcarei contenuti nell'acqua.

Non lasciare le posate nell'ambiente umido della lavastoviglie una volta terminato il ciclo di lavaggio, ma asciugarle e riporle in un ambiente asciutto.

Instruction of use and maintenance of stainless steel cutlery and hollowware

Wash the new products carefully before use. Use hot water to wash them and a good neutral detergent; then, rinse out with tepid water and dry all the items thoroughly. When washing, do not use chlorinated detergents nor products containing bleach. Pumice, steel wool, sponges or cloths saturated with abrasive powders must be strictly avoided. However, detergents without chloride containing fossil flour can be used. The washing of items after use is recommended. in case that would not be possible, it is however important not to leave for more than 12 hours the dirty items in contact with food leftovers (e.g.: if the items are used at lunch, they should be washed within the evening; if the items are used at dinner, they should be washed within the following morning). in case a prewash was needed, it must be carried out just before the washing and for a relatively short time. in fact, the items must not be soaked in the washing solution for too long, since some substances contained in food are damaging for the electroplating and change its appearance. Knives blades are manufactured with a valuable stainless steel and are sensitive to the corrosion attacks developed by acetic, citric and lactic acid and in particular to sodium chloride present in food.

in case of washing in dishwasher, spoons and forks must be placed into plastic vertical baskets and kept separated from knives.

Dry the items thoroughly immediately after the washing with a soft cloth, even if your dishwasher has a dry cycle. That is necessary in order to avoid the possible formation of stains caused by calcareous deposits contained in the water.

Do not leave the cutlery in the humid environment of the dishwasher once the washing finishes; dry them and store them in a dry place.













Superior

Inox 18/10 - St. Steel - 4 mm
Cod. CZ4..



COD. CZ4..

L. Mm

01	
02	
03	
05	
11	
12	
15	
21	
22	
31	
32	
38	

205

206

175

235

185

186

210

137

107

180













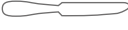



200

143



Amarcord

Inox 18/10 - St. Steel - 5 mm
Cod. CC2..

COD. CC2..		L. Mm
01		214
02		214
03		193
05		235
11		193
12		193
15		212
21		150
22		113
25		305
26		247
27		247
31		185
32		206
38		148
39		251
53		176
55		230

Dolce vita

Inox 18/10 - St. Steel - spessore forgiato
Cod. CB8..



COD. CB8..

L. Mm



214



214



214



235



193



193

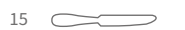

212

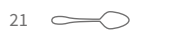

150

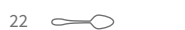

113



305



247



247



186



203



148













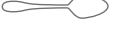

251



Dream

Inox 18/10 - St. Steel - 5.5 mm
Cod. CF9..

COD. CF9..		L. Mm
01		208
02		208
05		235
11		187
12		187
15		210
21		145
22		115
26		239
27		239
30		254
32		198
38		145
39		248













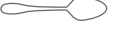

Niagara

Inox 18/10 - St. Steel - 5 mm
Cod. CZ3..



COD. CZ3..

L. Mm

01		210
02		203
05		231
11		181
12		183
15		210
21		142
22		113
25		306
26		237
27		234
38		160
39		250
53		175
55		228



Milord

Inox 18/10 - St. Steel - 4 mm
Cod. C14..

COD. C14..		L. Mm
01		197
02		198
03		172
05		233
08		225
11		177
12		178
15		195
18		200
21		133
22		104
25		310
26		228
27		227
31		198
32		212
35		195
36		172
37		129
38		143
39		240
42		175
53		168
55		230
67		184

Elegant

Inox 18/10 - St. Steel - 4 mm
Cod. CV6..



COD. CV6..



L. Mm
210



210



185



235

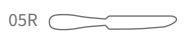

236



185



185



210



204



142

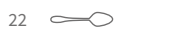

114



314



231



229



182



197



145



240



175



Relais

Inox 18/10 - St. Steel - 4 mm
Cod. CU3..

COD. CU3..		L. Mm
01		210
02		212
03		185
05		235
11		187
12		192
15		212
21		135
22		112
25		305
26		240
27		240
31		185
32		197
38		143
39		247
53		176
55		230













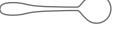



Ego

Inox 18/10 - St. Steel - 4 mm
Cod. CD3..



COD. CD3..

L. Mm

01		207
02		207
03		182
05		231
11		186
12		186
15		209
21		145
22		114
25		306
26		237
27		234
30		278
32		215
38		150
39		250



Slim

Inox 18/10 - St. Steel - 4 mm
Cod. CU7..

COD. CU7..	L. Mm
01	214
02	214
03	193
05	235
11	193
12	193
15	212
21	150
22	113
25	305
26	247
27	247
31	200
32	214
38	148
39	251
53	176
55	230

Ergo

Inox 18/10 - St. Steel - 4 mm
Cod. CE5..



COD. CE5..

L. Mm



207



207



182



231



186



186



209



145



114



306



237



234



215



150



250



175

















228



Dinamica

Inox 18/10 - St. Steel - 3 mm
Cod. Cm7..

COD. Cm7..		L. Mm
01		206
02		206
05		235
11		190
12		180
15		210
21		133
22		110
25		290
26		241
27		241
31		206
32		213
38		160
39		241

Allegra

Inox 18/10 - St. Steel- 3 mm
Cod. Cm6..



COD. Cm6..

01 

203

02 

201

05 

229

11 

180

12 

180

15 

203

21 

140

22 

106

38 

299

53 

176













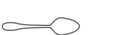

55 

230



Style

Inox 18/10 - St. Steel - 3 mm
Cod. CD6..

COD. CD6..		L. Mm
01		202
02		202
05		230
11		182
12		182
15		208
21		140
22		108
25		310
26		232
27		233
32		201
38		146
39		246















Linea

Inox 18/10 - St. Steel - 3 mm
Cod. CF7..



COD. CF7..

L. Mm

01		215
02		217
05		231
11		194
12		195,5
15		210
21		155
22		116
25		305
26		255
27		258
32		212
38		155
39		239



Step

Inox 18/10 - St. Steel - 3 mm
Cod. CF8..

COD. CF8..		L. Mm
01		200
02		200
03		178
05		230
11		179
12		181
15		207
21		140
22		109,7
26		231
27		234
30		260
31		180
32		193
38		146
39		255













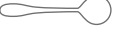
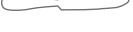

Più

Inox 18/10 - St. Steel - 3 mm
Cod. CD7..



COD. CD7..















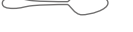

L. Mm

01		210
02		210
03		180
05		230
11		190
12		190
15		207
21		148
22		114
25		305
26		239
27		239
32		218
38		147
39		251
53		175



Marea

Inox 18/10 - St. Steel - 3 mm
Cod. CE4..

COD. CE4..		L. Mm
01		202
02		202
03		169
05		235
11		173
12		175
15		210
21		134
22		117
25		285
26		232
27		230
32		202
35		210
38		155
39		249
53		175











Gourmet

Inox 18/10 - St. Steel - 2,8 mm
Cod. CF5..



COD. CF5..

L. Mm

01		195
02		198
05		227
11		195
12		177
15		202
21		131
22		103
38		153
55		219



Cosmos

Inox 18/10 - St. Steel - 2,5 mm
Cod. C06..

COD. C06..	L. Mm
01	197
02	199
05	213
11	177
12	179
15	200
21	130
22	108
25	305
26	230
27	225
35	197
38	150
39	242
42	178

















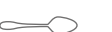

Mirage

Inox 18/10 - St. Steel - 2,5 mm
Cod. C17..



COD. C17..

L. Mm

01		197
02		200
03		173
05		213
06		223
11		178
12		179
15		199
21		135
22		110
25		314
26		230
27		229
31		203
32		222
35		210
38		159
39		247
55		210











Infinito

Inox 18/10 - St. Steel- 2,5 mm
Cod. CV7..

COD. CV7..

L. Mm

01		207
02		207
05		231
11		186
12		186
15		209
21		145
22		114
38		150













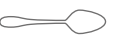



Flair

Inox 18/10 - St. Steel - 2,5 mm
Cod. C02..



COD. C02..

L. Mm

01		197
02		200
05		213
11		178
12		179
15		199
21		135
22		110
25		314
26		230
27		229
31		203
32		222
38		159
39		247
53		175
55		220



Baltic

Inox 18/10 - St. Steel - 2,5 mm
Cod. CB6..

COD. CB6..		L. Mm
01		195
02		195
05		216
06		215
11		181
12		176
15		192
21		134
22		105
25		307
26		233
27		232
28		223
29		221
32		208
35		209
38		140
39		244
63		158
68		151
69		151
70		166
COD. CB6KO..		
68		151
69		151
70		166











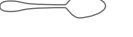

Monaco

Inox 18/10 - St. Steel - 2,5 mm
Cod. C34..



COD. C34..

L. Mm

01		196
02		195
05		211
11		170
12		173
15		190
21		131
22		110
27		223
31		195
32		205
38		155
39		238
42		???



Raffaello

Inox 18/10 - St. Steel - 2,5 mm
Cod. C20..

COD. C20..		L. Mm
01		198
02		196
03		177
05		209
11		177
12		178
15		202
21		136
22		112
25		299
26		222
27		210
28		214
29		214
38		152
39		245
42		178

Matisse

Inox 18/10 - St. Steel - 2,5 mm
Cod. CF1..

COD. CF1..



204



205



168



230



178



178



208



137



110



295



240



237



203



210



207

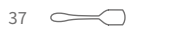

133



153



238



170



178



230



156



156













158





Azzurrea

Inox 18/10 - St. Steel - 2,5 mm
Cod. CP9..

COD. CP9..		L. Mm
01		197
02		195
05		216
11		179
12		177
15		198
21		133
22		113
35		205
38		148
53		167

Bella

Inox 18/10 - St. Steel - 2,2 mm
Cod. CE3..



COD. CE3..



L. Mm
204



204



175



230



183



183



207

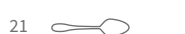

143

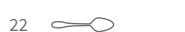

112



270



236



236













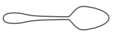

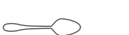
143



Brigitte

Inox 18/10 - St. Steel - 2 mm
Cod. C68..

COD. C68..		L. Mm
01		195
02		197
06		213
11		178
12		177
16		190
21		131
22		103
25		315
26		230
27		226
31		190
32		210
38		153
39		240

Naif

Inox 18/10 - St. Steel - 1,8 mm
Cod. CE8..



COD. CE8..

L. Mm



200



202



220



136



155



Rem

Inox 18/10 - St. Steel - 1,8 mm
Cod. C89..

COD. C89..		L. Mm
01		201
02		200
05		223
15		197
21		141
22		111
25		285
26		234
27		235
35		208
38		141
39		226
80		161







Pop

Inox 18/10 - St. Steel - 1,8 mm
Cod. CD4..

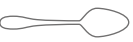

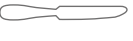
COD. CD4..

L. Mm

01	
02	
05	
06	
21	
22	
35	
38	

201

200

212

210

141

111









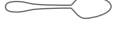

208

141



Mare

Acciaio inossidabile - St. Steel - 3 mm
Cod. CN8..

COD. CN8..		L. Mm
01		202
02		202
05		229
11		173
12		175
15		191
21		134
22		117
38		155
53		175
80		144

Med

Acciaio inossidabile - St. Steel - 2,2 mm
Cod. CT1..

**COD. CT1..**

204



205



230



137



110











Garda Top

Inox 18/10 - St. Steel - 4 mm
Cod. C82T..

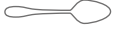

COD. C82T..

L. Mm

01		210
02		210
05		235
11		184
12		184
15		212
21		140
22		110
32		220
38		150



















Hermitage

Inox 18/10 - St. Steel - 5 mm
Cod. C09..



COD. C09..

L. Mm

01		202
02		201
03		178
05		228
11		182
12		181
15		205
21		142
22		107
25		312
26		262
27		258
31		200
32		215
38		146
39		252
42		180
53		175











N/900 Top

Inox 18/10 - St. Steel - 4 mm
Cod. CP2CST..























COD. CP2CST..

L. Mm

01		205
02		207
05		234
11		185
12		186
15		216
21		143
22		106
38		149

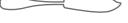







Rada

Inox 18/10 - St. Steel - 3 mm
Cod. C29..

COD. C29..	L. Mm
01 	208
02 	206
03 	175
04 	236
05 	230
11 	187
12 	187
14 	216
15 	210
21 	142
22 	141
25 	300
26 	227
27 	225
31 	182
32 	201
35 	139
37 	152
38 	142
39 	240
55 	220

Rada Top

Inox 18/10 - St. Steel - 4 mm
Cod. C29T..

COD. C29T..	L. Mm
01 	206
02 	207
04 	236
11 	187
12 	188
14 	216
21 	140
22 	110
38 	150



Imperial

Inox 18/10 - St. Steel - 3 mm
Cod. C04..



COD. C04..		L. Mm
01		207
02		208
03		174
05		239
08		247
11		187
12		188
15		216
18		214
21		141
22		111
23		116
25		315
26		239
27		239
28		206
29		205
31		186
32		210
33		242
34		260
35		192
36		174
37		133
38		145
39		240
40		255
42		164
53		170
55		220
67		188

Splendido

Inox 18/10 - St. Steel - 3,5 mm
Cod. C19..



COD. C19..

L. Mm

01  201

02  200

03  178

05  218

11  180

12  180

15  201

21  140

22  106

25  303

26  230

27  229

31  200

32  214

38  148

39  242













42  179

43  170



Perla

Inox 18/10 - St. Steel - 3 mm
Cod. CZ1..

COD. CZ1..	L. Mm
01 	200
02 	201
03 	176
05 	235
11 	180
12 	180
15 	204
21 	140
22 	104
31 	197
32 	208
38 	152

Vintage

Inox 18/10 - St. Steel - 3 mm
Cod. CB5..



COD. CB5..

01 

208

02 

206

05 

229

11 

187

12 

187

15 

206

21 

142

22 

117

25 

300

26 

227

27 

225

31 

181

32 

202

38 

152

39 

242

40 

237

55 











203

L. Mm



Condor

Inox 18/10 - St. Steel - 2,5 mm
Cod. C18..

























COD. C18..		L. Mm
01		196
02		194
05		212
11		170
12		173
15		197
21		130
22		110
26		227
27		223
38		155

Baguette

Inox 18/10 - St. Steel - 2,5 mm
Cod. CP1..

COD. CP1..

L. Mm



















01		205
02		205
03		169
05		246
08		225
11		179
12		179
15		195
18		200
21		143
22		110
25		295
26		239
27		236
31		205
32		211
35		207
37		133
38		154
39		238
42		172
45		178
53		175
55		212
67		179

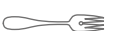



Silvia













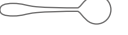
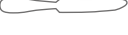
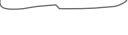









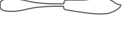

Inox 18/10 - St. Steel - 2,5 mm
Cod. CP7..

COD. CP7..		L. Mm
01		207
02		206
05		226
11		179
12		179
15		212
21		139
22		112
25		292
26		227
27		227
31		181
32		205
33		221
34		241
38		150
39		268
42		183

Victory

Inox 18/10 - St. Steel - 2,5 mm
Cod. CP2..

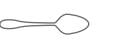
COD. CP2..











		L. Mm
01		203
02		204
03		167
05		221
06		214
08		247
11		178
12		179
15		208
16		191
18		214
21		137
22		110
25		299
26		239
27		236
31		203
32		210
35		206
37		132
38		153
39		235
42		170
45L		177
53		170
55		227
80		160

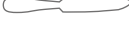























Enrico VIII

Inox 18/10 - St. Steel - 2,5 mm
Cod. CUB..

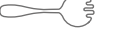
COD. CUB..		L. Mm
01		205
02		204
03		168
05		220
11		186
12		184
15		200
21		137
22		121
31		182
32		193
38		142









Alaska

Inox 18/10 - St. Steel - 2,2 mm
Cod. C24..

COD. C24..	L. Mm
01 	195
02 	195
05 	209
06 	212
11 	175
12 	176
15 	190
16 	190
21 	137
22 	103
25 	314
26 	223
27 	223
28 	207
29 	206
35 	208
37 	134
38 	152
39 	224
40 	223
42 	175

Alaska inox 18/CR

Acciaio inossidabile - St. Steel - 1,8 mm
Cod. CG3..

COD. CG3..	L. Mm
01 	195
02 	195
*06 	212
21 	128
22 	117
35 	208
37 	134
38 	175

*C2406L













England

Inox 18/10 - St. Steel - 2,2 mm
Cod. C97RO..



COD. C97RO..

L. Mm

01		203
02		201
05		229
11		180
12		180
15		203
21		140
22		106
38		144
39		245

London

Inox 18/10 - St. Steel - 2,2 mm
Cod. CP3..



COD. CP3..

L. Mm



203



204



220



177



177



209



137



110



304



237



237



152



234



237









177

Verve

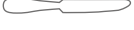
Inox 18/10 - St. Steel - 1,8 mm
Cod. C37..

**COD. C37..****L. Mm**

01		199
02		200
03		166
06		212
21		140
22		105
38		145

Reveil

Inox 18/10 - St. Steel - 1,8 mm
Cod. C30..



COD. C30..

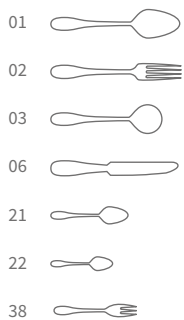









L. Mm

200
200
170
228
140
105
145

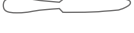

Scozia

Acciaio inossidabile - St. Steel - 3,0 mm
Cod. CN6..

COD. CN6..		L. Mm
01		200
02		200
05		229
11		180
12		180
15		203
21		138
22		105
38		143

Boston

Inox 18/10 satinato - Mat finishing St. Steel - 2,5 mm
Cod. C39..



COD. C39..

L. Mm

01  195

02  196

05  213

11  173

12  177

15  192

21  132

22  116

25  308

26  225

27  222

28  203

29  205

31  190

32  204

35  206

37  131

38  153

39  240

40  259

42  185











Firenze

Inox 18/10 - St. Steel - 2,5 mm
Cod. C84..

COD. C84..

L. Mm

01		195
02		196
05		208
11		173
12		175
15		194
21		132
22		116
38		152

River

Inox 18/10 - St. Steel - 2,2 mm
Cod. CV9..



COD. CV9..



195



194



229



172



174



191



129



111



153









Brinner

Inox 18/10 satinato - Mat finishing St. Steel - 2,2 mm
Cod. C43..

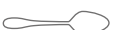
COD. C43..

L. Mm

01		195
02		196
05		216
11		171
12		171
15		190
21		129
22		111

Rimini

Inox 18/10 satinato - Mat finishing St. Steel - 2 mm
Cod. C45..



COD. C45..



195



194



229



172



174



191



129



111











153











Toronto

Inox 18/10 -- St. Steel - 2,0 mm
Cod. CH8..

COD. CH8..		L. Mm
01		195
02		196
05		213
11		173
12		177
15		192
21		132
22		116
38		153

Toronto inox 18/CR

Acciaio inossidabile - St. Steel - 1,8 mm
Cod. CG8..

COD. CG8..		L. Mm
01		195
02		196
* 05		213
21		132
22		116
35		206
37		131
38		153

*CH805











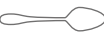

Malta

Inox 18/10 - St. Steel - 1,8 mm
Cod. C60..



COD. C60..

L. Mm

01		194
02		193
05		215
11		174
12		175
15		194
21		122
22		102
25		298
26		224
27		222
38		141
39		244
42		167











Sef

Inox 18/10 - St. Steel - 1,8 mm
Cod. C24..L

COD. C24..L

L. Mm















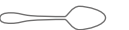



01		195
02		195
06		212
21		128
22		117
35		208
37		134
38		175

Valencia

Inox 18/10 - St. Steel - 1,8 mm
Cod. CR9..

COD. CR9..

L. Mm

01		195
02		198
03		169
05		224
06		215
11		177
12		179
15		209
16		192
21		138
22		110
25		298
26		240
27		236
31		198
32		201
35		207
37		135
38		154











Valencia inox 18/CR

Acciaio inossidabile - St. Steel - 1,8 mm
Cod. CG2..

COD. CG2..

L. Mm









01		195
02		198
*06		215
21		138
22		110
35		207
37		135
38		154

*CR906

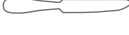
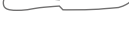
Corona







Inox 18/10 - St. Steel - 1,8 mm
Cod. CS0..



COD. CS0..		L. Mm
01		195
02		198
03		169
05		221
06		215
11		177
12		179
15		207
21		138
22		110
38		154

Murano







Inox 18/10 - St. Steel - 1,8 mm
Cod. CD5..

COD. CD5..		L. Mm
01		199
02		201
06		211
21		140
22		105
38		145



Murano inox 18/CR

Acciaio inossidabile - St. Steel- 1,8 mm
Cod. CG5..











COD. CG5..		L. Mm
01		199
02		201
* 06		211
21		140
22		105
35		187
38		145

*CD506



Luisa

Inox 18/10 - St. Steel - 1,8 mm
Cod. CS4..

COD. CS4..		L. Mm
01		193
02		196
06		212
11		179
12		180
16		190
21		130
22		124
35		187
37		134
38		145

Oslo

Acciaio inossidabile satinato
Mat finishing St. Steel - 2 mm
Cod. C49..



COD. C49..

L. Mm

01  192

02  192

05  210

11  174

12  177

15  190

21  127

22  113

25  283

26  233

27  226









38  151

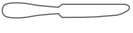

Eva

Acciaio inossidabile - St. Steel - 1,5 mm
Cod. CT4E..

COD. CT4E..**L. Mm**

01		194
02		193
06		209
21		129
22		110
35		207
37		134
38		154

Corsaro

Acciaio inossidabile - St. Steel - 1,5 mm
Cod. CV1..



COD. CV1..

L. Mm



195



195



212



130



103

















159



America

Acciaio inossidabile - St. Steel - 1,5 mm
Cod. C46..

COD. C46..		L. Mm
01		193
02		193
05		210
06		212
11		173
12		170
15		190
16		190
21		120
22		102
26		222
27		221
38		141
55		215





New Line

Acciaio inossidabile / ABS - St. Steel / ABS - 2 mm
Cod. PV9..

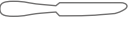

COD. PV9..

L. Mm

01		200
02		205
05		215
21		142
55		216



07



13



14



19



24



47



In & Out

Plastica / plastic
Cod. PV8..

In & Out è la nuova linea di posate in nylon vetrificato versatile, informale e colorata che Abert propone per essere utilizzata con creatività, in casa come in giardino, al ristorante o a bordo piscina, al bar o in barca. Date sfogo alla fantasia con le posate In & Out e usatele quando e dove volete e con serenità: sono solide e resistenti, interamente prodotte in Italia, riutilizzabili e lavabili in lavastoviglie.

In & Out is the new glossy-glazed-nylon cutlery, versatile, informal and lively that Abert offers to be used with creativity at home and in the garden, at the restaurant or at the pool side, at the bar or in the boat. Let your imagination run wild with In & Out cutlery and use it when and where you wish and don't be afraid: it is robust and resistant, entirely made in Italy, reusable and washable in dishwasher.

COD. PV8..	L. Mm
01	203
02	201
05	218
21	132

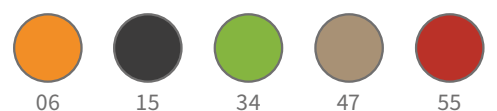

Baltic Abi

Inox 18/10 - St. Steel - 2,5 mm
Cod. CB6S..



COD. CB6S..

L. Mm



195



195



216



134

Punzonatura Laser

Laser punching
Poinçonnage laser
Laser-Lochen
Punzonado laser

**Punzonatura Meccanica**

Mechanical punching
Poinçonnage mécanique
Mechanish-Lochen
Punzonado mecánico

Ordini minimi 6.000 pezzi per articolo
6.000 pcs/item minimum orders
Commandes minimales de 6.000 pcs par article
Bestellungen von 6.000/Stücke mindestens
Pedidos mínimos de 6.000 pzs por artículo

**Punzonatura Pantografo**

Pantograph punching
Poinçonnage par pantographe
Gravierung
Punzonado con pantógrafo

**Doratura**

Gold-plating
Dorure
Vergoldung
Dorado





PVD

La tecnica PVD (Physical Vapour Deposition) permette di depositare un film metallico di alto spessore con caratteristiche sorprendenti dal punto di vista decorativo e tecnico. Questo procedimento rende il prodotto trattato durevole nel tempo e conferisce elevata durezza superficiale. L'articolo diventa resistente ai solventi, agli acidi e a vari prodotti usati in cucina, mantenendo intatte le proprie caratteristiche chimico/fisiche. E' un trattamento assolutamente biocompatibile, anallergico ed idoneo al contatto con il cibo.

Polvere di Luna

La finitura Polvere di Luna rende l'aspetto delle posate satinato e delicatamente brillante: una superficie levigata con chiaroscuri. Piacevoli e vellutate al tatto, trasmettono una morbidezza ed un calore inconsueto per oggetti di acciaio. Un rivestimento sobrio ed inusuale per posate contemporanee.

Vintage

L'opacità, i graffi ed i segni volutamente prodotti sulla superficie delle posate con finitura Vintage danno la sensazione di oggetti vissuti ed utilizzati a lungo, di grandi cucine profumate, calde e piene di vapore, di convivialità di altri tempi, di sapori antichi. Evocano immagini di ambienti tradizionali, rustici e senza pretese di modernità.

FINITURE SPECIALI • SPECIAL FINISH

PVD

The PVD (Physical Vapour Deposition) technique allows to deposit a high-thickness metal film with remarkable characteristics from the decorative and technical point of view. Such process makes the product treated durable in time and gives high surface hardness. The item turns resistant to solvents, acids and to various products used in the kitchen, keeping its chemical/physical characteristics unchanged. It is a thoroughly biocompatible, anallergic treatment and suitable for food contact.

Polvere di Luna

The Polvere di Luna finish makes cutlery surface look satin-like and delicately brilliant: a smooth surface with contrasting shades. Pleasant and velvety to the touch, the cutlery so treated convey a softness and warmth unusual for steel objects. A sober and unusual coating for contemporary cutlery.

Vintage

Opacity, scratches and marks intentionally made on the surface of the cutlery with a finish give the effect of objects that have been used for a long time, of a large, warm and steamy kitchen filled with aromas, of the friendly gatherings of old good times and ancient flavours. They evoke images of traditional, simple environments with no intention to be modern.

PVD

PVD

Cod. ...41 Oro - Gold

Cod. ...40 Rame - Copper

Cod. ...42 Nero - Black



Finitura disponibile per tutti i modelli

Finish available for all models

Non disponibile per posate a manico cavo

Not available for hollow-handle cutlery

Minimo di ordine 500 pz assortiti

500 assorted pcs minimum order

PVD oro

PVD Gold

Cod. ...41

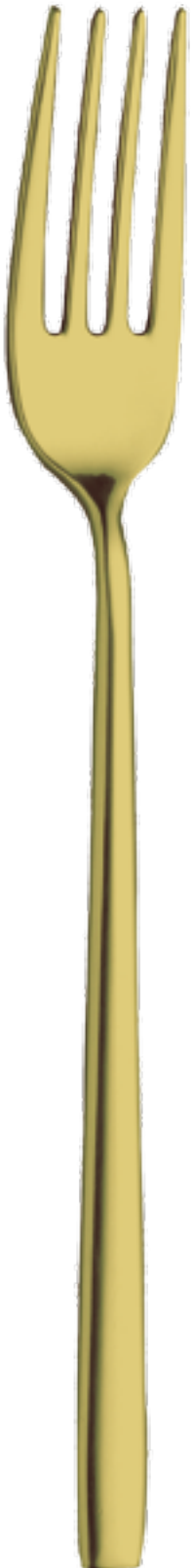

PVD rame

PVD Copper

Cod. ...40

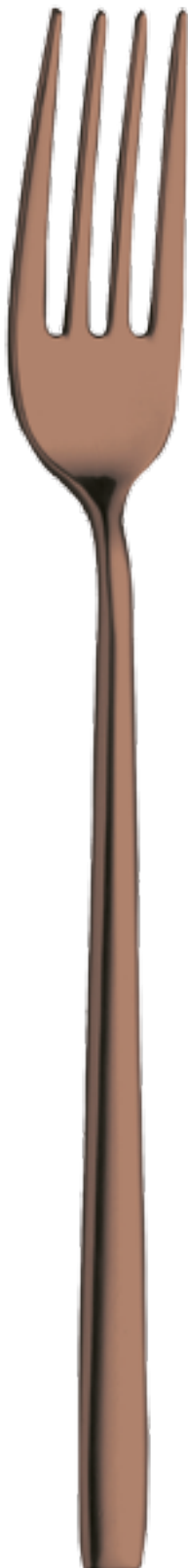

PVD nero

PVD Black

Cod. ...42



Polvere di Luna

Moon Dust
Cod. ...32



Finitura disponibile per tutti i modelli

Finish available for all models

Non disponibile per posate a manico cavo

Not available for hollow-handle cutlery

Minimo di ordine 500 pz assortiti

500 assorted pcs minimum order

Polvere di Luna PVD oro

Moon Dust PVD Gold

Cod. ...35



Polvere di Luna PVD rame

Moon Dust PVD Copper

Cod. ...53



Polvere di Luna PVD nero

Moon Dust PVD Black

Cod. ...39



Vintage

Vintage
Cod. ...51



Finitura disponibile per tutti i modelli

Finish available for all models

Non disponibile per posate a manico cavo

Not available for hollow-handle cutlery

Minimo di ordine 500 pz assortiti

500 assorted pcs minimum order

Vintage PVD oro

Vintage PVD Gold

Cod. ...57



Vintage PVD rame

Vintage PVD Copper

Cod. ...56



Vintage PVD nero

Vintage PVD Black

Cod. ...58







ACCESSORI • ACCESSORIES



Break&Fast la nuova linea di accessori speciali firmata Abert.

Cinque accessori, ognuno con una funzione specifica, per rendere unica ogni colazione, ma non solo: spuntini, merende, aperitivi...

La linea è composta da due grandi classici immancabili: palettina Moka e cucchiaino Caffè. Break&Fast propone inoltre il cucchiaio Cereali, che con i fori permette al latte di colare ed è l'ideale anche per sgocciolare olive, sottaceti, etc. Completano la linea la Spatolina, ideale per burro, marmellata, creme, creme al cioccolato e salsine, e il cucchiaino Yogurt, che con la sua forma è perfetto anche per gustare marmellate, confetture, creme, creme al cioccolato, gelati e dolci al cucchiaio. Questi due ultimi prodotti, grazie alla loro forma, permettono di raccogliere ogni residuo da barattoli e contenitori.

Designer: Valerio De Cecco e Lorenzo Sottini

Break&Fast the new special accessories set by Abert.

Five accessories, everyone created to make unique every breakfast, but not only: luncheon, snack, brunch...

The set is composed of two great essential classic items: Coffee Stirrer and Tea Spoon. Break&Fast also presents Cereal Spoon, with holes that allow the milk to drip and it is perfect to drain olives, pickles, etc... The Spatula Spoon, perfect for butter, jam, creams, chocolate creams and sauces, and the Yogurt Spoon, which is perfect to taste jams, marmalades, creams, chocolate creams, ice-creams and spoon desserts, complete the set. Thanks to their shapes, these last two products allow to remove the food remaining from cans and containers.

Designers: Valerio De Cecco e Lorenzo Sottini

Cucchiaio cereali

Cereal spoon
Cuillère à céréales
Cerealienlöffel
Cuchara de cereales

Inox 18/10 - St. Steel

	Mm	In
908 05 00 006	185	7,1/4

**Cucchiaino tè/moka**

Tea spoon
Cuillère à moka
Tee-/Mokkalöffel
Cuchara de moka

Inox 18/10 - St. Steel

	Mm	In
908 05 00 003	120	4,3/4



Paletta miscelatore

Coffee stirrer
 Agitateur à café
 Kaffee-Rührer
 Paleta café

Inox 18/10 - St. Steel

	Mm	In
908 05 00 005	100	4

**Cucchiaino spatolina**

Spatula spoon
 Cuillère spatule
 Spatel - /Spatenlöffel
 Cuchinilla spatula

Inox 18/10 - St. Steel

	Mm	In
908 05 00 002	149	6

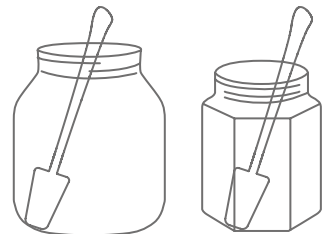
**Cucchiaino yogurt/cioccolato/marmellata**

Yogurt / chocolate / jam spoon
 Cuillère à yaourt / chocolat / confiture
 Joghurt / Schokoladen / Marmeladenlöffel
 Cuchara yogur / chocolate / mermelada

Inox 18/10 - St. Steel

	Mm	In
908 05 00 001	121	4,3/4



Cucchiaio moka appetizer con foro Linea

Linea moka spoon appetizer with hole
 Cuillère à moka de mise en bouche avec trou Linea
 Appetizer Mokalöffel mit Lock Linea
 Cuchara moka aperitivo con agujero Linea

Inox 18/10 - St. Steel

	Mm	In
CF7P 22F	106	4,1/8

**Cucchiaio caffè' appetizer Linea**

Linea tea spoon appetizer
 Cuillère à thé de mise en bouche Linea
 Appetizer Kaffee/Teelöffel Linea
 Cuchara café aperitivo Linea

Inox 18/10 - St. Steel

	Mm	In
CF7P 21	122	4,3/4

**Forchetta 2 punte appetizer Linea**

Linea fork appetizer, two-prong
 Fourchette de mise en bouche à deux dents Linea
 Appetizer Zweizinkengabel Linea
 Tenedor aperitivo dos puntas Linea

Inox 18/10 - St. Steel

	Mm	In
CF7P 63	105	4,1/8

**Cucchiaio moka appetizer Linea**

Linea moka spoon appetizer
 Cuillère à moka de mise en bouche Linea
 Appetizer Mokkalöffel Linea
 Cuchara moka aperitivo Linea

Inox 18/10 - St. Steel

	Mm	In
CF7P 22	106	4,1/8

**Cucchiaio bibita appetizer Linea**

Linea cocktail spoon
 Cuillère à mazagran Linea
 Cocktaillöffel Linea
 Cuchara refresco Linea

Inox 18/10 - St. Steel

	Mm	In
CF7P 35	210	8,1/4

**Forchetta dolce Svezia**

Svezia cake fork
 Fourchette à gâteau Svezia
 Kuchengabel Svezia
 Tenedor lunch Svezia

Acciaio Inox - St. Steel

	Mm	In
CSV 38	145	5,3/4

**Cucchiaio bibita Svezia**

Svezia cocktail spoon
 Cuillère à cocktail Svezia
 Cocktaillöffel Svezia
 Cuchara refresco Svezia

Acciaio Inox - St. Steel

	Mm	In
CSV 35	204	8

**Cucchiaino gelato Svezia**

Svezia ice cream spoon
 Cuillère à glace Svezia
 Eislöffel Svezia
 Cuchara helado Svezia

Acciaio Inox - St. Steel

	Mm	In
CSV 37	131	5,1/8



Cucchiaino moka Riflesso

Riflesso moka spoon
Cuillère à moka Riflesso
Mokkalöffel Riflesso
Cuchara moka Riflesso

Inox 18/10 - St. Steel

	Mm	In
C33P 22	108	4,3/8

**Cucchiaino caffè Riflesso**

Riflesso coffee spoon
Cuillère à café Riflesso
Kaffee/Teelöffel Riflesso
Cuchara café Riflesso

Inox 18/10 - St. Steel

	Mm	In
C33P 21	130	5,7/8

**Paletta gelato Riflesso**

Riflesso ice cream spoon
Cuillère à glace Riflesso
Eislöffel Riflesso
Cuchara helado Riflesso

Inox 18/10 - St. Steel

	Mm	In
C33P 37	130	5,1/8

**Cucchiaino bibita Riflesso**

Riflesso cocktail spoon
Cuillère à cocktail Riflesso
Cocktailöffel Riflesso
Cuchara refresco Riflesso

Inox 18/10 - St. Steel

	Mm	In
C33P 35	201	7,7/8

**Cucchiaino caffè con piega Riflesso**

Riflesso s-shaped tea spoon
Cuillère à thé pliée
Riflesso - Gebogener Teelöffel Riflesso
Cucharita café plegada Riflesso

Inox 18/10 - St. Steel

	Mm	In
C33P 392	115	4,1/2

**Cucchiaino bibita con piega Riflesso**

Riflesso s-shaped cocktail spoon
Cuillère à mazagran pliée Riflesso
Gebogener Cocktailöffel Riflesso
Cuchara refresco plegada Riflesso

Inox 18/10 - St. Steel

	Mm	In
C33P 394	185	7,1/4

**Forchettina dolce Riflesso**

Riflesso cake fork
Fourchette à gâteau Riflesso
Kuchengabel Riflesso
Tenedor lunch Riflesso

Inox 18/10 - St. Steel

	Mm	In
C33P 38	144	5,3/4

**Forchettina 2 punte Riflesso**

Riflesso two-prong fork
Fourchette à deux dents Riflesso
Zweizinkengabel Riflesso
Tenedor dos puntas Riflesso

Inox 18/10 - St. Steel

	Mm	In
C33P 63	144	5,3/4



Cucchiaino caffè bar

Bar coffee spoon
Cuillère à café bar
Kaffee/Teelöffel Bar
Cuchara café bar

Acciaio Inox - St. Steel

	Mm	In
903 06 81 020	133	5,1/8

**Cucchiaino moka 903**

903 Moka spoon
Cuillère à café 903
Mokalöffel 903
Cuchara moka 903

Acciaio Inox - St. Steel

	Mm	In
903 06 81 024	111	4,3/8

**Cucchiaino fragola e confetti Milord**

Milord sweet spoon
Cuillère à sucreries Milord
Erdbeer- und Konfektlöffel Milord
Cuchara para dulces Milord

Inox 18/10 - St. Steel

	Mm	In
C14 36	170	6,5/8

**Cucchiaino fragola e confetti Imperial**

Imperial sweet spoon
Cuillère à sucreries Imperial
Erdbeer- und Konfektlöffel Imperial
Cuchara para dulces Imperial

Inox 18/10 - St. Steel

	Mm	In
C04 36	170	6,5/8

**Cucchiaino olive con fori**

Olive slotted spoon
Cuillère de mise en bouche olives perforée
Gelochter Oliven Löffel
Cuchara aceitunas perforada

Inox 18/10 - St. Steel

	Mm	In
903 05 81 AOF	225	8,7/8

**Cucchiaino olive**

Olive spoon
Cuillère de mise en bouche olives
Oliven Löffel
Cuchara aceitunas

Inox 18/10 - St. Steel

	Mm	In
903 05 81 AOL	225	8,7/8



Cucchiaio multiuso Matisse grande

Matisse slotted spoon large
 Cuillère à servir perforée Matisse grande
 Großer Universallöffel Matisse
 Cuchara para servir perforada Matisse grande

Inox 18/10 - St. Steel

	Mm	In
CF1 162	205	8,1/8

**Cucchiaio ghiaccio Matisse grande**

Matisse slotted long ice spoon
 Cuillère à glaçons perforée Matisse grande
 Großer Eiswürfelloffel Matisse
 Cucharón hielo perforado Matisse grande

Inox 18/10 - St. Steel

	Mm	In
CF1 253	205	8,1/8

**Cucchiaio multiuso Matisse piccolo**

Matisse slotted spoon
 Cuillère à servir perforée Matisse
 Kleiner Universallöffel Matisse
 Cuchara para servir perforada Matisse

Inox 18/10 - St. Steel

	Mm	In
CF1 161	170	6,5/8

**Cucchiaio ghiaccio Matisse piccolo**

Matisse slotted ice spoon
 Cuillère à glaçons perforée Matisse
 Kleiner Eiswürfelloffel Matisse
 Cuchara hielo perforada Matisse

Inox 18/10 - St. Steel

	Mm	In
CF1 251	170	6,5/8

**Cucchiaio multiuso Pop**

Pop slotted spoon
 Cuillère à servir perforée Pop
 Universallöffel Pop
 Cuchara para servir perforada Pop

Inox 18/10 - St. Steel

	Mm	In
CD4 162	202	7,8/8

**Cucchiaio ghiaccio Pop**

Pop slotted ice spoon
 Cuillère à glaçons perforée Pop
 Eiswürfelloffel Pop
 Cucharón hielo perforado Pop

Inox 18/10 - St. Steel

	Mm	In
CD4 253	202	7,8/8



Abert presenta Double, il nuovo utensile per... l'assaggio!

Innovativo: grazie alla sua forma metà cucchiaio e metà forchetta è l'unico strumento in grado di permettere assaggi di cibi liquidi e solidi.

Irrinunciabile per gli chef, che possono finalmente sperimentare tutte le loro preparazioni con un solo oggetto nel taschino.

Ingenoso e pratico per assaporare i cibi in occasione di degustazioni, aperitivi o buffet.

Abert presents Double, the new tool for... tasting!

Innovative: thanks to its shape half spoon and half fork, it is an instrument able to allow tastes of liquid and solid foods.

Essential for chefs, who can at last experiment all their preparations with just one object in their small pocket.

Ingenious and practical in order to savour foods at tastings, happy hours or buffets.

Double

Double
Double
Doppel
Double

Inox 18/10 - St. Steel

	Mm	In
903 05 81 DFS	165	6,1/2

**Appetizer Matisse con riccio**

Curled appetizer
Cuillère de mise en bouche en boucle
Appetizerlöffel
Aperitivo con nudo - cuchara

Inox 18/10 - St. Steel

		Mm	In
CF1 CR	SPOON	141	5,1/2
CF1 FR	FORK	136	5,3/8

**Appetizer Matisse con piega - cucchiaio**

Bended appetizer spoon
Cuillère de mise en bouche pliée
Appetizerlöffel
Aperitivo plegada - cuchara

Inox 18/10 - St. Steel

		Mm	In
CF1 CP	SPOON	142	5,1/2
CF1 FP	FORK	138	5,3/8



**Forchettina appetizer segnaposto**

Place-card appetizer fork
Fourchette de mise en bouche marque-place
Tischkarte Appetizer Gabel
Tenedor aperitivo etiqueta

Inox 18/10 - St. Steel

	H Mm	H In
903 05 81 APF	97	3,7/8

Tapas Matisse

Matisse Tapas
Cuillère Tapas Matisse
Tapas Matisse
Tapas Matisse

Inox 18/10 - St. Steel

	Mm	In
CF1 TA	170	6,3/4

**Cucchiaio appetizer tondo**

Appetizer curved spoon
Cuillère de mise en bouche ronde pliée
Appetizer - rund gebogener Löffel
Cuchara aperitivo redonda plegada

Inox 18/10 - St. Steel

	Mm	In
903 05 81 APC	140	5,1/2

**Appetizer Brigitte con piega**

Bended appetizer spoon Brigitte
Mise en bouche pliée Brigitte
Appetizerlöffel Brigitte
Aperitivo plegada Brigitte

Inox 18/10 - St. Steel

	Mm	In
C68 CP	142	5,1/2 SPOON
C68 FP	142	5,1/2 FORK

**Mini appetizer Ego**

Ego mini appetizer
Mini mise en bouche Ego
Mini Appetizer Ego
Mini aperitivo Ego

Inox 18/10 - St. Steel

	Mm	In
CD3 38M	115	4,1/2 FORK
CD3 22	115	4,1/2 SPOON



Coltello carne Modern seghettato

Modern steak knife
 Couteau à bifteck Modern
 Modern Steakmesser
 Cuchillo carne Modern

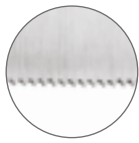
**Acciaio Inox - St. Steel**

	Mm	In
903 06 86 A	227	9

**Coltello carne Modern filo rasoio**

Modern steak knife
 Couteau à bifteck Modern
 Modern Steakmesser
 Cuchillo carne Modern

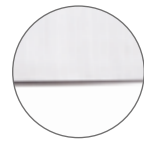
**Acciaio Inox - St. Steel**

	Mm	In
903 06 86 B	227	9

**Coltello Angus seghettato**

Angus steak knife
 Couteau à bifteck Angus
 Angus Steakmesser
 Cuchillo carne Angus

**Acciaio Inox - St. Steel**

	Mm	In
CAN 55	229	9

**Coltello Angus filo rasoio**

Angus steak knife
 Couteau à bifteck Angus
 Angus Steakmesser
 Cuchillo carne Angus

**Acciaio Inox - St. Steel**

	Mm	In
CAN 55R	229	9

**Coltello carne lama 12 Cm**

Steak knife, blade 12Cm
 Couteau à bifteck 12Cm
 12Cm Steakmesser
 Cuchillo carne 12Cm

Acciaio Inox - St. Steel

	Mm	In
AVRI 180	228	9

**Coltello carne Kansas**

Kansas steak knife
 Couteau à bifteck Kansas
 Kansas Steakmesser
 Cuchillo carne Kansas

Acciaio Inox - St. Steel

	Mm	In
CKA 55	218	8,5/8



Coltello carne Kobe

Kobe steak knife
 Couteau à bifteck Kobe
 Kobe Steakmesser
 Cuchillo carne Kobe



Acciaio inox - St. Steel

	Mm	In
CKO 55	244	9,5/8



Coltello carne Kobe

Kobe steak knife
 Couteau à bifteck Kobe
 Kobe Steakmesser
 Cuchillo carne Kobe

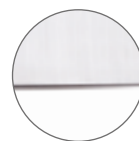

Acciaio inox - St. Steel

	Mm	In
CKO 55R	244	9,5/8



Coltello carne Fuego

Fuego steak knife
 Couteau à bifteck Fuego
 Fuego Steakmesser
 Cuchillo carne Fuego



Acciaio Inox - St. Steel

	Mm	In
CFU 55	232	9



Coltello carne Fuego

Fuego steak knife
 Couteau à bifteck Fuego
 Fuego Steakmesser
 Cuchillo carne Fuego

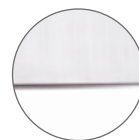

Acciaio Inox - St. Steel

	Mm	In
CFU 55R	232	9



Coltello pizza Azzurra

Azzurra pizza knife
 Couteau à pizza Azzurra
 Azzurra Pizzamesser
 Cuchillo pizza Azzurra

Acciaio Inox - St. Steel

	Mm	In
CZ 7134	225	8,7/8



Forchetta pizza Azzurra

Azzurra pizza fork
 Fourchette à pizza Azzurra
 Azzurra Pizzagabel
 Tenedor pizza Azzurra

Acciaio Inox - St. Steel

	Mm	In
CZ 752	200	7,7/8



Coltello fiorentina

Fiorentina steak knife
 Couteau à bifteck Fiorentina
 Fiorentina Steakmesser
 Cuchillo carne Fiorentina

Acciaio Inox - St. Steel

	Mm	In
CFI 55	230	9

**Forchetta fiorentina**

Fiorentina steak fork
 Fourchette à bifteck Fiorentina
 Fiorentina Steakgabel
 Tenedor carne Fiorentina

Inox 18/10 - St. Steel

	Mm	In
CFI 02	204	8

**Coltello carne Pampero**

Pampero steak knife
 Couteau à bifteck Pampero
 Pampero Steakmesser
 Cuchillo carne Pampero

Acciaio inox - St. Steel

	Mm	In
CPP 55	222	8,5/8

**Forchetta carne Pampa**

Pampa steak fork
 Fourchette à bifteck Pampa
 Pampa Steakgabel
 Tenedor carne Pampa

Inox 18/10 - St. Steel

	Mm	In
CPA 52	197	7,5/8

**Coltello carne Malaga**

Malaga steak knife
 Couteau à bifteck Malaga
 Malaga Fleischmesser
 Cuchillo carne Malaga

Acciaio inox - St. Steel

	Mm	In
CMA 55	231	8,5/8

**Forchetta carne Altozano/Malaga**

Altozano steak fork
 Fourchette à bifteck Altozano
 Altozano Steakgabel
 Tenedor carne Altozano

Acciaio Inox - St. Steel

	Mm	In
CAL 52	205	8



Coltello pizza Modern acciaio

Modern pizza knife
Couteau à pizza Modern
Modern Pizzamesser
Cuchillo pizza Modern

Acciaio inox - St. Steel

	Mm	In
CPI 05P	205	8

**Forchetta pizza Modern acciaio**

Modern pizza fork
Fourchette à pizza Modern
Modern Pizzagabel
Tenedor pizza Modern

Acciaio inox - St. Steel

	Mm	In
CPI 02 CR	203	7,7/8

**Coltello carne America monoblocco**

America steak knife, solid handle
Couteau à bifteck America monobloc
Steakmesser America, monoblock
Cuchillo carne America monobloque

Acciaio inox - St. Steel

	Mm	In
C46 55	210	9

**Coltello carne/bistecca Matisse**

Regis steak knife
Couteau à bifteck Regis
Regis Steakmesser
Cuchillo carne Regis

Acciaio inox - St. Steel

	Mm	In
CF1 55	230	9

**Coltello pizza Palio**

Pizza knife Palio
Couteau à pizza Palio
Palio Pizzamesser
Cuchillo pizza Palio

Acciaio inox - St. Steel

	Mm	In
CC3 134	210	8,1/4

**Coltello carne Modern acciaio**

Modern steak knife
Couteau à bifteck Modern
Modern Steakmesser
Cuchillo carne Modern

Acciaio inox - St. Steel

	Mm	In
CPI 05	226	8,7/8



Coltello carne Rost punta

Rost steak knife
 Couteau à viande Rost
 Fleischmesser Rost
 Cuchillo carne Rost

Acciaio inox manico nero

AVARI 064B 06 pz.6
 AVARI 064B 12 pz.12

**Coltello carne Rost punta tonda**

Rost steak knife round point
 Couteau à viande Rost pointe ronde
 Fleischmesser Rost
 Cuchillo carne Rost con punta redonda

Acciaio inox manico nero

AVARI 064T B06 pz.6
 AVARI 064T B12 pz.12

**Coltello pizza Rost**

Pizza knife Rost
 Couteau à pizza Rost
 Rost Pizzamesser
 Cuchillo pizza Rost

Acciaio inox manico nero

AVARI 064P B06 pz.6
 AVARI 064P B12 pz.12

**Coltello spelucchino Rost**

Rost paring knife
 Couteau à éplucher Rost
 Schälmesser Rost
 Cuchillo guarnecer Rost

Acciaio inox manico nero

AVARI 064S B06 pz.6
 AVARI 064S B12 pz.12

**Coltello carne Arlecchino punta**

Arlecchino steak knife
 Couteau à viande Arlecchino
 Fleischmesser Arlecchino
 Cuchillo carne Arlecchino

Acciaio inox colori assortiti

	Mm	In	
● AVARI 047 47	211	8,1/4	pz.6
● AVARI 047 07	211	8,1/4	pz.6
○ AVARI 047 13	211	8,1/4	pz.6
● AVARI 047 34	211	8,1/4	pz.6
● AVARI 047 06	211	8,1/4	pz.6
○ AVARI 047 19	211	8,1/4	pz.6
● AVARI 047 14	211	8,1/4	pz.6

**Coltello carne Arlecchino punta tonda**

Arlecchino steak knife round point
 Couteau à viande Arlecchino pointe ronde
 Fleischmesser Arlecchino
 Cuchillo carne Arlecchino con punta redonda

Acciaio inox colori assortiti

	Mm	In	
● AVARI 047T 47	211	8,1/4	pz.6
● AVARI 047T 07	211	8,1/4	pz.6
○ AVARI 047T 13	211	8,1/4	pz.6
● AVARI 047T 34	211	8,1/4	pz.6
● AVARI 047T 06	211	8,1/4	pz.6
○ AVARI 047T 19	211	8,1/4	pz.6
● AVARI 047T 14	211	8,1/4	pz.6



Pinza aragosta forgiata

Lobster cracker, forged
Pince à homard forgé
Langustezange - geschmieden
Pinzas langosta forjadas

Acciaio Inox - St. Steel

	Mm	In
305 05 91 658	210	8,1/4

**Stiletto aragosta**

Lobster pick
Fourchette à homard
Langustegabel
Tenedor langosta

Inox 18/10 - St. Steel

	Mm	In
903 05 84 659	202	7,7/8

**Forchettina ostriche**

Oyster fork
Fourchette à crustacés
Austerngabel
Tenedor ostras

Inox 18/10 - St. Steel

	Mm	In
CF1 64	156	6,1/8

**Stiletto ostriche/crostacei**

Oyster fork
Fourchette à crustacés
Krustengabel
Tenedor mariscos

Inox 18/10 - St. Steel

	Mm	In
CPA 64	227	8,7/8

**Forchettina 2 punte Matisse**

Matisse fork, two-prong
Fourchette à deux dents Matisse
Zweizinkengabel Matisse
Tenedor dos puntas Matisse

Inox 18/10 - St. Steel

	Mm	In
CF1 63	156	3,1/8

**Molla lumache**

Snail tongs
Pince à escargots
Schneckenzange
Pinzas caracoles

Acciaio Inox - St. Steel

	Mm	In
903 05 81 MLU	160	6,1/4



Coltello formaggi cremosi Regis Spalmy

Spalmy creamy cheese knife
 Couteau à fromages crèmeux Spalmy
 Schmelzkäsemesser Spalmy
 Cuchillo quesos cremosos Spalmy

Acciaio Inox - St. Steel

	Mm	In
903 05 84D	225	8,7/8

**Coltello paste molli Regis Tommy**

Tommy tender cheese knife
 Couteau à fromages à pâte molle Tommy
 Weichkäsemesser Tommy
 Cuchillo quesos pasta blanda Tommy

Acciaio Inox - St. Steel

	Mm	In
903 05 84A	218	8,5/8

**Coltello 2 punte Regis Emmy**

Emmy medium-hard cheese knife
 Couteau à fromages à pâte demi-ferme Emmy
 Milderkäsemesser Emmy
 Cuchillo quesos pasta semi-dura Emmy

Acciaio Inox - St. Steel

	Mm	In
903 05 84B	221	8,5/8

**Coltello formaggi di paste crude Regis Parmy**

Parmy hard cheese knife
 Couteau à fromages à pâte ferme Parmy
 Hartkäsemesser Parmy
 Cuchillo quesos pasta dura Parmy

Acciaio Inox - St. Steel

	Mm	In
903 05 84C	199	7,7/8

**Coltello formaggelle Regis Formy**

Formy formaggelle soft cheese knife
 Couteau à fromages à pâte molle formaggelle Formy
 Frischkäsemesser Formy
 Cuchillo quesos pasta blanda formaggelle Formy

Acciaio Inox - St. Steel

	Mm	In
903 05 84E	273	10,5/8

**Coltello agrumi Regis**

Regis citrus fruit knife
 Couteau à agrumes Regis
 Orangenmesser Regis
 Cuchillo cítricos Regis

Acciaio Inox - St. Steel

	Mm	In
903 05 84 269	220	8,5/8

**Affettaformaggio Regis 18/10**

Regis cheese slicer
 Pelle coupe-fromage Regis
 Käsehobel Regis
 Pala corta queso Regis

Acciaio Inox - St. Steel

	Mm	In
903 05 84 135	190	7,1/2



Schiaccianoci Forgiato

Nut cracker - forged
Casse noix forgé
Nußknacker geschmieden
Cascanueces forjado

Inox 18/10 - St. Steel

	Mm	In
AVARI 117	150	6

**Schiaccianoci**

Nut cracker
Casse noix
Nußknacker
Cascanueces

Inox 18/10 - St. Steel

	Mm	In
903 05 84 163	220	8,5/8

**Paletta raccoglibriciole**

Crumb sweeper
Pelle ramasse-miettes
Krümelsammler
Pala recogemigas

Inox 18/10 - St. Steel

	Mm	In
903 05 91 939	160	6,1/4

**Easy Spaghetti e pasta 3 in 1****Dosaspaghetti - Assaggiapaghetti - Assaggiapasta**

Spaghetti doser - Spaghetti taster - Pasta taster
Doseur spaghetti - Goute-spaghetti - Goute-pâtes
Spaghetti-Maß - Spaghettitester - Nudel-Tester
Dosificador de espagueti - Prueba espagueti - Prueba pasta

Inox 18/10 - St. Steel

	Mm	In
903 05 81 ESP	225	8,7/8



Forchettone spaghetti

Spaghetti serving fork
Fourchette à servir spaghetti
Spaghettigabel
Tenedor servir spaghetti

Inox 18/10 - St. Steel

	Mm	In
903 05 91 792	278	11

**Mestolo punch**

Punch ladle
Louche à punch
Bowlenlöffel
Cazo punch Svezia

Acciaio Inox - St. Steel

	Mm	In
CSV 66	280	11

**Cucchiaio insalata con piega Pivot**

Pivot curved salad spoon
Grosse cuillère à salade pliée Pivot
Gebogene Salatlöffel Pivot
Cuchara ensalada plegada Pivot

Inox 18/10 - St. Steel

	Mm	In
CD8 28	255	10,1/8

**Forchetta insalata con piega Pivot**

Pivot curved salad fork
Grosse fourchette à salade pliée Pivot
Gebogene Salatgabel Pivot
Tenedor ensalada plegado Pivot

Inox 18/10 - St. Steel

	Mm	In
CD8 29	255	10,1/8

**Cucchiaio forato multiuso con piega Pivot**

Pivot curved slotted spoon
Cuillère perforée à servir pliée Pivot
Gebogener, gelochter Universallöffel Pivot
Cuchara perforada para servir plegada Pivot

Inox 18/10 - St. Steel

	Mm	In
CD8 162	255	10,1/8

**Cucchiaio ghiaccio multiuso con piega Pivot**

Pivot slotted long ice spoon
Cuillère à glaçons / salade pliée Pivot
Gebogener Universaleislöffel Pivot
Cucharón hielo / ensalada plegado Pivot

Inox 18/10 - St. Steel

	Mm	In
CD8 253	255	10,1/8



Mestolo con piega

S-shaped soup ladle
 Louche pli e
 Gebogener Sch opfl offel
 Cazo sopa plegado

Inox 18/10 - St. Steel

	Mm	In
C00 25CP	275	10,7/8

**Cucchiaio macedonia con piega**

S-shaped fruit salad spoon
 Cuill re   salade de fruits pli e
 Gebogener Obstsalatl offel
 Cuchara ensalada de frutas plegada

Inox 18/10 - St. Steel

	Mm	In
C00 27CP	215	8,1/2

**Forchetta multiuso con piega**

S-shaped fork
 Fourchette pli e
 Gebogene Universalgabel
 Tenedor plegado

Inox 18/10 - St. Steel

	Mm	In
C00 26CP	215	8,1/2

**Cucchiaio servi miele con piega**

S-shaped honey serving spoon
 Cuill re   miel pli e
 Gebogener Honigl offel
 Cuchara para miel plegada

Inox 18/10 - St. Steel

	Mm	In
C89 390	140	5,1/2



Cucchiaio insalata Regis

Regis salad-serving spoon
Cuillère à salade Regis
Salatlöffel Regis
Cuchara ensalada Regis

Inox 18/10 - St. Steel

	Mm	In
903 05 84 028	248	9,1/2

**Forchetta insalata Regis**

Regis salad-serving fork
Grosse fourchette salade Regis
Salatgabel Regis
Tenedor ensalada Regis

Inox 18/10 - St. Steel

	Mm	In
903 05 84 029	237	9,1/4

**Cucchiaione servire Regis**

Regis serving spoon
Cuillère à servir Regis
Löffel Regis
Cucharón servir Regis

Inox 18/10 - St. Steel

	Mm	In
903 05 84 793	260	10,1/4

**Forchettone servire Regis**

Regis serving fork
Fourchette à servir Regis
Gabel Regis
Tenedor servir Regis

Inox 18/10 - St. Steel

	Mm	In
903 05 84 794	260	10,1/4

**Cucchiaione tondo Regis**

Regis round serving spoon
Grosse cuillère ronde Regis
Rundlöffel Regis
Cucharón redondo Regis

Inox 18/10 - St. Steel

	Mm	In
903 05 84 797	272	10,5/8

**Cucchiaione tondo forato Regis**

Regis round slotted serving spoon
Grosse cuillère ronde perforée Regis
Gelochter Rundlöffel
Cucharón redondo con perforado Regis

Inox 18/10 - St. Steel

	Mm	In
903 05 84 796	275	10,7/8



Cucchiaione riso Regis

Regis rice-serving spoon
Grosse cuillère à riz Regis
Reislöffel Regis
Cucharón arroz Regis

Inox 18/10 - St. Steel

	Mm	In
903 05 84 795	260	10,1/4

**Spatola gelato Regis**

Regis ice cream server
Spatule à glace Regis
Eisschaufel Regis
Cuchara servir helado Regis

Inox 18/10 - St. Steel

	Mm	In
903 05 84 059	237	9,1/4

**Coltellone dolce/panettone Regis**

Regis bread knife
Gros couteau à pain Regis
Kuchmesser Regis
Cuchillo pan Regis

Inox 18/10 - St. Steel

	Mm	In
903 05 84 788	303	12

**Pala dolce Regis**

Regis cake server
Pelle à tarte Regis
Tortenschaufel Regis
Pala pastel Regis

Inox 18/10 - St. Steel

	Mm	In
903 05 84 799	268	10,5/8

**Coltellone arrosto carving Regis**

Regis carving knife
Gros couteau rôti Regis
Fleischmesser Regis
Cuchillo asado Regis

Acciaio Inox - St. Steel

	Mm	In
903 05 84 786	331	13

**Forchettone arrosto carving Regis**

Regis carving fork
Grosse fourchette rôti Regis
Fleischgabel Regis
Tenedor asado Regis

Inox 18/10 - St. Steel

	Mm	In
903 05 84 064	266	10,3/8



Cucchiaione riso professionale

Professional rice-serving spoon
Cuillère à riz professionnelle
Reislöffel
Cucharón arroz profesional

Inox 18/10 - St. Steel

	Mm	In
903 05 91 795	256	10

**Pala fritto professionale**

Professional frying palette
Pelle à friture professionnelle
Schaufel
Pala frito profesiona

Inox 18/10 - St. Steel

	Mm	In
903 05 91 062	295	11,5/8

**Cucchiaione forato professionale**

Professional slotted serving spoon
Cuillère perforée professionnelle
Gelochter Löffel
Cucharón servir perforado profesional

Inox 18/10 - St. Steel

	Mm	In
903 05 91 796	290	11,1/2

**Cucchiaione ghiaccio professionale**

Professional ice-serving spoon
Cuillère à glaçons professionnelle
Eislöffel
Cucharón hielo profesional

Inox 18/10 - St. Steel

	Mm	In
903 05 91 063	290	11,1/2

**Cucchiaione insalata professionale**

Professional salad-serving spoon
Cuillère à salade professionnelle
Salatlöffel
Cucharón ensalada profesional

Inox 18/10 - St. Steel

	Mm	In
903 05 91 066	285	11,1/4

**Cucchiaione servire professionale**

Professional serving spoon
Cuillère à servir professionnelle
Löffel
Cucharón servir profesional

Inox 18/10 - St. Steel

	Mm	In
903 05 91 793	290	11,1/2

**Cucchiaino riso forato professionale**

Professional rice-serving spoon
Cuillère à riz professionnelle
Reislöffel
Cucharón arroz profesional

Inox 18/10 - St. Steel

	Mm	In
903 05 91 795 F	256	10

**Mestolo Professionale**

Professional ladle
Louche professionnelle
Professionelle Schöpfkelle
Cazo profesional

Inox 18/10 - St. Steel

	Mm	In
903 05 91 025	288	11,3/4



Forchettone servire professionale

Professional serving fork
Fourchette à servir professionnelle
Gabel
Tenedor servir profesional

Inox 18/10 - St. Steel

	Mm	In
903 05 91 794	294	11,5/8

**Forchettone arrosto professionale**

Professional carving fork
Grande fourchette rôti professionnelle
Fleischgabel
Tenedor asado profesional

Inox 18/10 - St. Steel

	Mm	In
903 05 91 064	285	11,1/4

**Coltello torta seghettato professionale**

Professional serrated-edge cake knife
Couteau à gâteau professionnel lame dentelée
Kuchmesser
Cuchillo pastel profesional dentado

Inox 18/10 - St. Steel

	Mm	In	
903 05 91 788	297	11,3/4	seghettato / serrated

**Coltello torta professionale**

Professional cake knife
Couteau à gâteau professionnel
Tortennmesser
Cuchillo pastel profesional

Inox 18/10 - St. Steel

	Mm	In
903 05 91 798	297	11,3/4

**Pala torta seghettata professionale**

Professional serrated-edge cake server
Pelle à gâteau dentelée professionnelle
Tortenschaufel
Pala pastel profesional dentada

Inox 18/10 - St. Steel

	Mm	In
903 05 91 786	297	11,3/4

**Pala torta professionale**

Professional cake server
Pelle à gâteau professionnelle
Tortenschaufel
Pala pastel profesional

Inox 18/10 - St. Steel

	Mm	In
903 05 91 799	297	11,3/4

**Spatola crepes professionale**

Professional crepes server
Spatule à crêpes professionnelle
Crepesschaufel
Pala crepes profesional

Inox 18/10 - St. Steel

	Mm	In
903 05 91 065	292	11,1/2

**Pala gratin professionale**

Professional gratin server
Pelle à gratin professionnelle
Backschaufel
Pala lasaña profesional

Inox 18/10 - St. Steel

	Mm	In	
903 05 91 787	268	10,5/8	seghettata / serrated
903 05 91 787	268	10,5/8	



Molla insalata o vegetali

Salad-vegetable tongs
Pince à légumes
Gemüsezange
Pinza para ensalada

Acciaio Inox - St. Steel

	Mm	In
CI 18601	195	7,5/8

**Molla servire**

Serving tongs
Pince à servir
Servierzange
Pinza de servicio

Acciaio Inox - St. Steel

	Mm	In
CI 18602	195	7,5/8

**Molla asparagi**

Asparagus tongs
Pince à asperges
Spargelzange
Pinza para espàrragos

Acciaio Inox - St. Steel

	Mm	In
CI 18603	195	7,5/8

**Molla pasta**

Pasta tongs
Pince pasta
Pastazange
Pinza pasta

Acciaio Inox - St. Steel

	Mm	In
CI 18604	195	7,5/8

**Molla dolci / toast**

Cake tongs
Pince à pâtisserie
Gebäckzange
Pinza para pasteles

Acciaio Inox - St. Steel

	Mm	In
CI 18703	180	7



Molla insalata Long

Salad tongs
Pince à salade
Salatzange
Pinzas ensalada

Acciaio Inox - St. Steel

	Mm	In
903 05 81 MIN	270	10,5/8

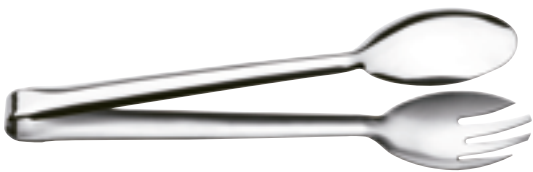
**Molla pasta Long**

Pasta tongs
Pince à pâtes
Pastazange
Pinzas pasta

Acciaio Inox - St. Steel

	Mm	In
903 05 81 MPA	270	10,5/8

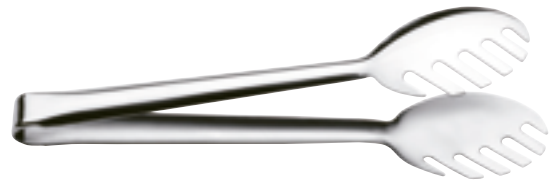
**Molla multiuso Long**

Multipurpose tongs
Pince à servir
Multipurposezange
Pinzas para servir

Acciaio Inox - St. Steel

	Mm	In
903 05 81 MMU	295	11,5/8

**Molla Universal Long**

Universal tongs
Pince Universal
Universalzange
Pinzas Universal

Acciaio Inox - St. Steel

	Mm	In
903 05 81 MUN	270	10,5/8



Molla arrosto Modern

Roast tongs
Pince à rôti
Fleischzange
Pinzas asado

Acciaio Inox - St. Steel

	Mm	In
903 05 81 MAR	250	8,7/8

**Molla dolci Modern**

Cake tongs
Pince à gâteaux
Gebäckzange
Pinzas postre

Acciaio Inox - St. Steel

	Mm	In
903 05 81 MDO	250	8,7/8

**Molla ghiaccio Modern**

Ice tongs
Pince à glaçons
Eiszange
Pinzas hielo

Acciaio Inox - St. Steel

	Mm	In
903 05 81 MGH	200	7,7/8

**Molla spaghetti Modern**

Spaghetti tongs
Pince à spaghetti
Spaghetizange
Pinzas spaghetti

Acciaio Inox - St. Steel

	Mm	In
903 05 81 MSP	250	8,7/8



Molla per pane Cosmos

Cosmos bread tongs
Pince à pain Cosmos
Brotzange Cosmos
Pinzas pan Cosmos

Acciaio inossidabile - St. Steel

	Cm	In
● V53 05 81 MPA 15	22,5	8,7/8
● V53 05 81 MPA 34	22,5	8,7/8
● V53 05 81 MPA 41	22,5	8,7/8
● V53 05 81 MPA 43	22,5	8,7/8
● V53 05 81 MPA 47	22,5	8,7/8

**Molla per spaghetti Cosmos**

Cosmos spaghetti tongs
Pince à spaghetti Cosmos
Spaghettizange Cosmos
Pinzas spaghetti Cosmos

Acciaio inossidabile - St. Steel

	Cm	In
● V53 05 81 MSP 15	23	9,1/8
● V53 05 81 MSP 34	23	9,1/8
● V53 05 81 MSP 41	23	9,1/8
● V53 05 81 MSP 43	23	9,1/8
● V53 05 81 MSP 47	23	9,1/8

**Molla per arrosto Cosmos**

Cosmos roast tongs
Pince à rôti Cosmos
Braten/Fleischzange Cosmos
Pinzas asado Cosmos

Acciaio inossidabile - St. Steel

	Cm	In
● V53 05 81 MAR 15	22	8,5/8
● V53 05 81 MAR 34	22	8,5/8
● V53 05 81 MAR 41	22	8,5/8
● V53 05 81 MAR 43	22	8,5/8
● V53 05 81 MAR 47	22	8,5/8

**Molla per dolce Cosmos**

Cosmos cake tongs
Pince à gâteau Cosmos
Gebäckzange Cosmos
Pinzas postre Cosmos

Acciaio inossidabile - St. Steel

	Cm	In
● V53 05 81 MDO 15	22	8,5/8
● V53 05 81 MDO 34	22	8,5/8
● V53 05 81 MDO 41	22	8,5/8
● V53 05 81 MDO 43	22	8,5/8
● V53 05 81 MDO 47	22	8,5/8

**Molla per ghiaccio Cosmos**

Cosmos ice tongs
Pince à glace Cosmos
Eiszange Cosmos
Pinzas hielo Cosmos

Acciaio inossidabile - St. Steel

	Cm	In
● V53 05 81 MGH 15	21,4	8,3/8
● V53 05 81 MGH 34	21,4	8,3/8
● V53 05 81 MGH 41	21,4	8,3/8
● V53 05 81 MGH 43	21,4	8,3/8
● V53 05 81 MGH 47	21,4	8,3/8







- BUFFET

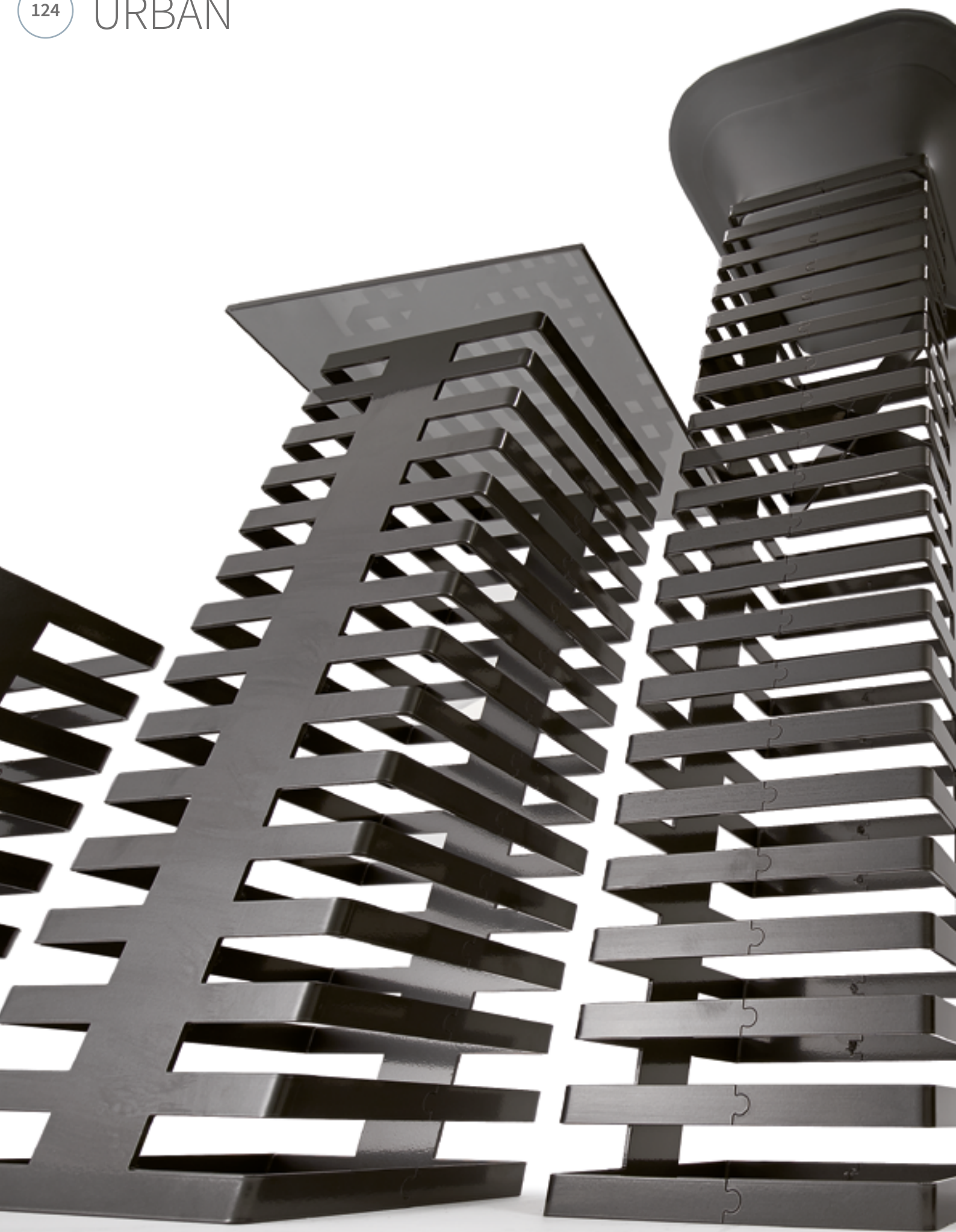

Urban

Abert firma Urban, un supporto creativo per le preparazioni in sala, versatile, fantasioso e bello da vedere.

Base ideale per un buffet di finger food, impeccabile supporto da colazione grazie ai numerosi accessori correlati e perfetto allestimento emozionale per aperitivi e brunch.

Urban è facile da allestire e consente la veloce creazione di figure geometriche modulari sempre diverse, per posizionare ogni creazione culinaria secondo la propria fantasia.

Abert has designed Urban, a creative support for food preparation in the restaurants, versatile, multipurpose and nice to see.

Ideal base for a finger-food buffet, perfect lunch podium system thanks to the numerous accessories provided, and impressive set-up for the happy hour and the brunch.

Urban is easy to assemble and allows the fast creation of continuously different modular shapes, in order to place every food preparation according to everyone's imagination.

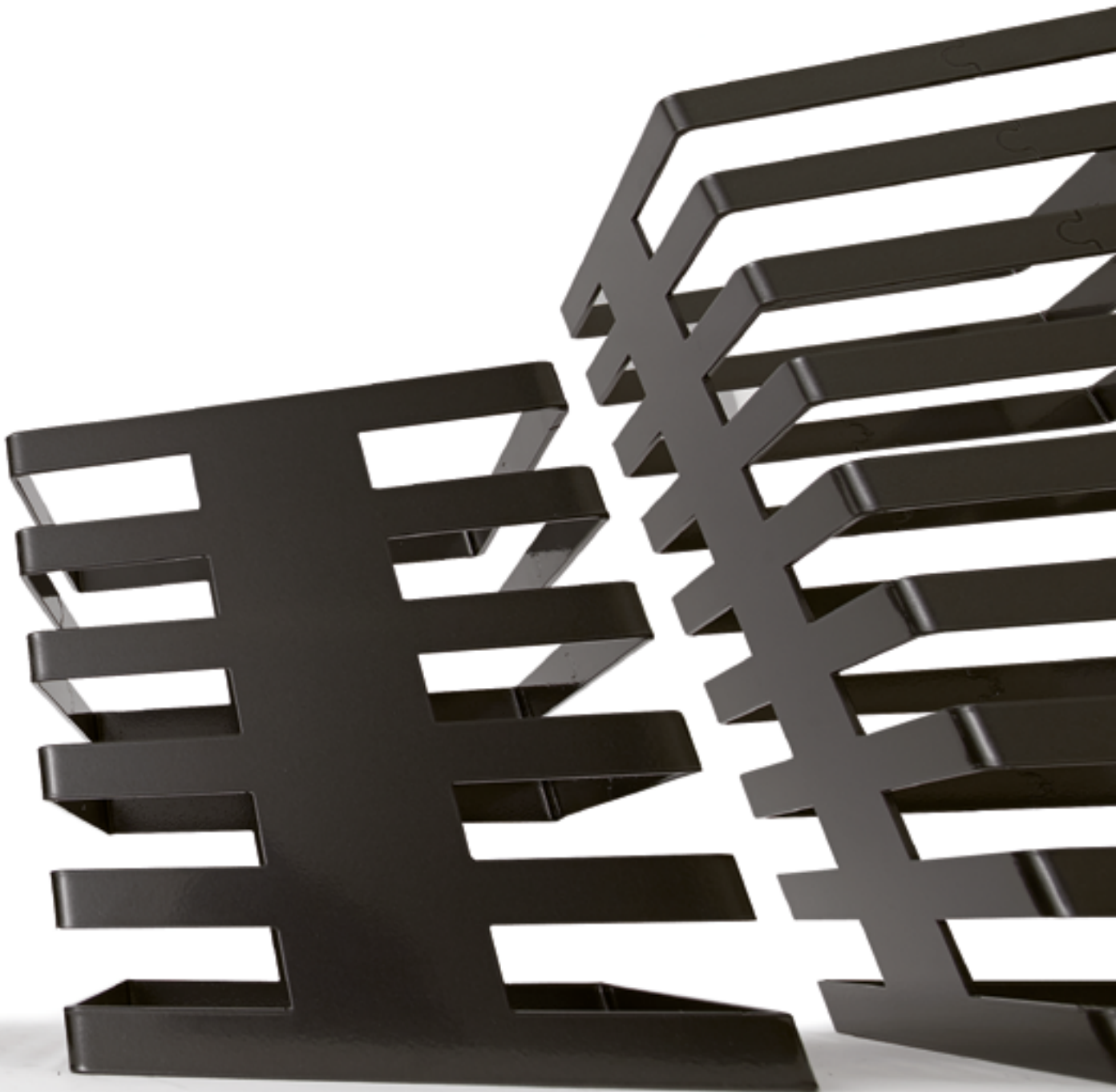

**SET 1**

Urban Tower
Tower Urban
Tower Urban
Urban Tower

V87 32 42 001	Cm	H Cm
	140x42	67
	In	H In
	55,1/8x16,1/2	26,3/8

**SET 4**

Urban Tower
Tower Urban
Tower Urban
Urban Tower

V87 32 42 004	Cm	H Cm
	260x42	67
	In	H In
	102,1/8x16,1/2	26,3/8

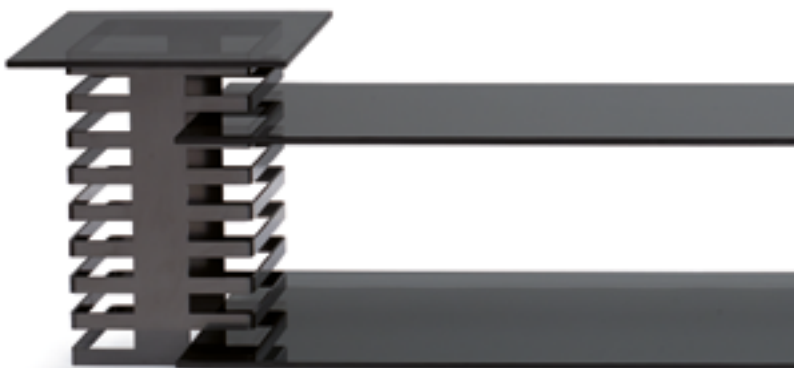

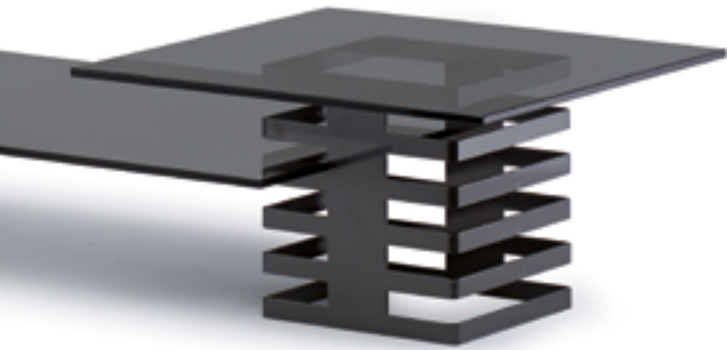

SET 3

Urban Tower
Tower Urban
Tower Urban
Urban Tower

V87 32 42 003

Cm	H Cm
150x145	67
In	H In
59,1/8x57,1/8	26,3/8

SET 2

Urban Tower
Tower Urban
Tower Urban
Urban Tower

V87 32 02 002

Cm	H Cm
140x42	43
In	H In
55,1/8x16,1/2	17



Tower

Tower
Tower
Tower
Tower

	Cm	H Cm	In	H In
V87 18 42 001	20x20	10	7,7/8x7,7/8	4
V87 18 42 002	20x20	22	7,7/8x7,7/8	8,5/8
V87 18 42 003	20x20	34	7,7/8x7,7/8	13,3/8
V87 18 42 004	20x20	58	7,7/8x7,7/8	22,7/8

**Modulo a croce**

Cross-shaped extension unit
Croix
Verbindungskreuz
Módulo con forma de cruz

	H Cm	In
V87 18 42 CRO	9,5	3,3/4

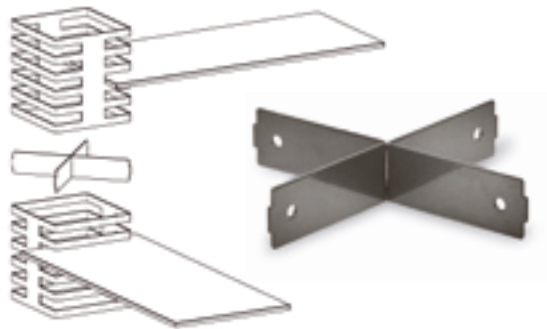
**Scala angolare 4 ripiani**

4-shelf corner ladder
Etagère angulaire 4 étages
Eck-Leiter (4 Stufen) Plexiglas
Escalera angular 4 estantes

	Cm	H Cm	In	H In
V87 12 42 SA2	40x40	10	15,3/4x15,3/4	4

**Coppa quadrata in plexiglass fumé**

Smoky plexiglass salad bowl, square
Bol plexiglass fumé carrén
Salatschale Plexiglas viereckig Smoky
Ensaladera acrílica fumé cuadrada

	Cm	H Cm	In	H In
V87 12 42 C01	34x34	11	13,3/8x13,3/8	4,3/8
V87 12 42 C02	34x34	19	13,3/8x13,3/8	7,1/2

**Piatto quadrato plexiglass fumé**

Smoky plexiglass buffet plate, square
Plat plexiglass fumé carré
Buffetplatte Plexiglas viereckig Smoky
Plato acrílico fumé cuadrado

	Cm	In
V87 12 42 P01	30x30	11,3/4x11,3/4

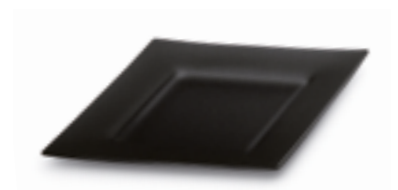

Piano in vetro fumé

Smoky glass top
 Dessus en verre fumé
 Glasplatte Smoky
 Tablero de cristal fumé

	Cm	In
V87 08 42 Q01	30x30	11,3/4x11,3/4
V87 08 42 Q02	42x42	16,1/2x16,1/2
V87 08 42 R01	30x70	11,3/4x27,1/2
V87 08 42 R02	30x100	11,3/4x39,3/8
V87 08 42 R03	42x70	16,1/2x27,1/2
V87 08 42 R04	42x100	16,1/2x39,3/8

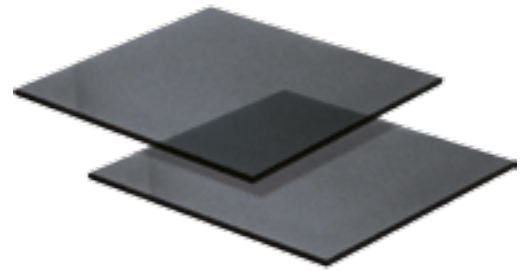
**Piano in ardesia**

Slate top
 Dessus en ardoise
 Schieferplatte
 Tablero de pizarra

	Cm	In
V87 09 42 Q01	30x30	11,3/4x11,3/4
V87 09 42 Q02	42x42	16,1/2x16,1/2
V87 09 42 R01	30x70	11,3/4x27,1/2
V87 09 42 R02	30x100	11,3/4x39,3/8
V87 09 42 R03	42x70	16,1/2x27,1/2
V87 09 42 R04	42x100	16,1/2x39,3/8

**Piano in mdf**

Mdf top
 Dessus en mdf
 Mdf Platte
 Tablero de mdf

	Cm	In
V87 04 42 Q01	30x30	11,3/4x11,3/4
V87 04 42 Q02	42x42	16,1/2x16,1/2
V87 04 42 R01	30x70	11,3/4x27,1/2
V87 04 42 R02	30x100	11,3/4x39,3/8
V87 04 42 R03	42x70	16,1/2x27,1/2
V87 04 42 R04	42x100	16,1/2x39,3/8

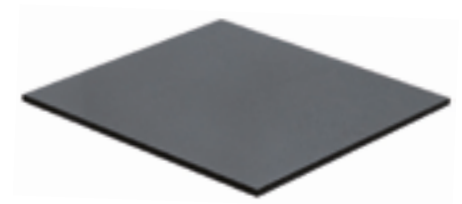
**Totem**

Totem
 Totem
 Totem
 Totem

	Cm	H Cm	In	H In
V87 18 42 T01	29x29	14	11,1/2x11,1/2	5,1/2
V87 18 42 T02	42x42	22	16,1/2x16,1/2	8,5/8



**Scaldavivande da incasso
con coperchio in acciaio inox**

Built-in chafing dish with St. Steel cover
Chafing dish encastrable avec couvercle en acier inox
Chafing Dish zum Einbauen mit Edelstahl Deckel
Chafing dish para empotrar con tapa en acero inox

	GN	Cm	H Cm
V87 18 52 002	1/1	60,5x40,5	39,5
		In	H In
		23,7/8x16	15,1/2

2 fornelletti - 2 burners



**Scaldavivande da incasso
con coperchio in acciaio inox /vetro**

Built-in chafing dish with St. Steel / glass cover
Chafing dish encastrable avec couvercle en acier inox / verre
Chafing Dish zum Einbauen mit Edelstahl / Glass Deckel
Chafing dish para empotrar con tapa en acero inox / vidrio

	GN	Cm	H Cm
V87 18 52 003	1/1	60,5x40,5	39,5
		In	H In
		23,7/8x16	15,1/2

2 fornelletti - 2 burners



Scaldavivande con gambe e coperchio in acciaio inox

Chafing dish with St. Steel stand and cover
Chafing dish avec support et couvercle en acier inox
Chafing Dish mit Beinen und Edelstahldeckel
Chafing dish con soporte y tapa en acero inox

	GN	Cm	H Cm
V87 18 52 001	1/1	63x42	31
		In	H In
		25,3/4x16,1/2	12,1/4

2 fornelli - 2 burners

	GN	Cm	H Cm
V87 18 52 004	2/3	46x42	32
		In	H In
		18,1/8x16,1/2	12,5/8

1 fornello - 1 burner



Completo di due fornelli a combustibile solido e predisposto per piastra elettrica.
Portavivande in acciaio incluso

*With two solid fuel burners,
electric heating element available.
With Gastronorm food pan*

Scaldavivande con gambe e coperchio acciaio inox/vetro

Chafing dish with St. Steel/glass stand and cover
Chafing dish avec support et couvercle en acier inox / verre
Chafing Dish mit Beinen und Edelstahl / Glass deckel
Chafing dish con soporte y tapa en acero inox / vidrio

	GN	Cm	H Cm
V87 18 52 005	1/1	63x42	33
		In	H In
		25,3/4x16,1/2	12,1/4

2 fornelli - 2 burners

	GN	Cm	H Cm
V87 18 52 006	2/3	46x42	32
		In	H In
		18,1/8x16,1/2	12,5/8

1 fornello - 1 burner



Completo di due fornelli a combustibile solido e predisposto per piastra elettrica.
Portavivande in acciaio incluso

*With two solid fuel burners,
electric heating element available.
With GN 1/1 Gastronorm food pan*

Caratteristiche tecniche

- A** Asportabilità del coperchio a 90° con estrema facilità.
- B** Coperchio leggero e facilmente maneggiabile.
- C** Blocco automatico dell'estrazione del coperchio in fase di lavoro (da 0° a 89°).
- D** Chiusura e apertura frenata del coperchio. Sistema di cerniere brevettate Abert
- E** Il coperchio si ferma, quando è lasciato, in qualsiasi posizione da 0° a 70°.
- F** Superati i 70° il coperchio si apre completamente lasciandolo andare.
- G** La cerniera è un meccanismo a molla, inalterabile nel tempo, non necessita di regolazione e di manutenzione in quanto non ha frizione.
- H** Tutti i meccanismi sono costruiti in pregiati materiali inossidabili, quindi resistenti alla corrosione, agli ambienti umidi e adatti al contatto con gli alimenti.
- I** Lo scaldavivande è progettato per raccogliere la condensa in modo da lasciare il piano di appoggio completamente asciutto.
- L** Può essere utilizzato sia con riscaldamento elettrico sia con fornelli a combustibile solido.

Technical characteristics

- A** Easily removable cover, at 90°.
- B** Light and easy-to-handle cover.
- C** Automatic block of cover pull out when in operation (from 0° to 89°).
- D** Closing and opening slowed by cover. Abert patented system.
- E** The cover stops, when released, in any position from 0° to 70°.
- F** Over 70° the cover opens fully when released.
- G** The hinge is a spring mechanism, inalterable in time, it does not need regulation and maintenance as it has no clutch.
- L** All the machineries are built in refined stainless materials, thus resistant to corrosion, humid environment and suitable for food contact.
- I** The chafing dish is designed to collect condensation, in order to keep the support base completely dry.
- L** Both electric warming and solid-fuelburners can be used.

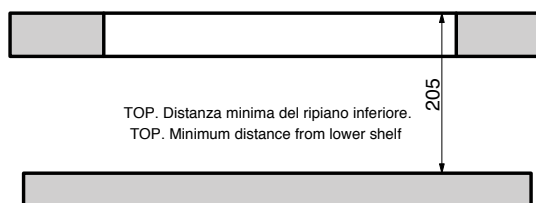
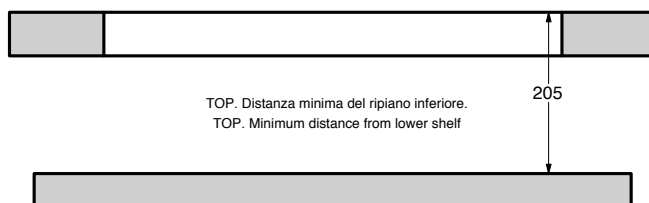
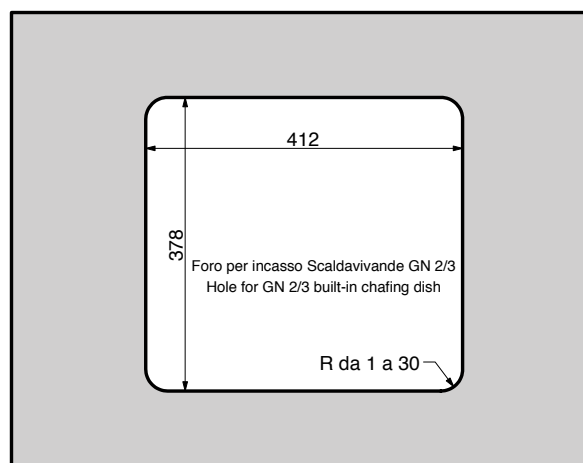
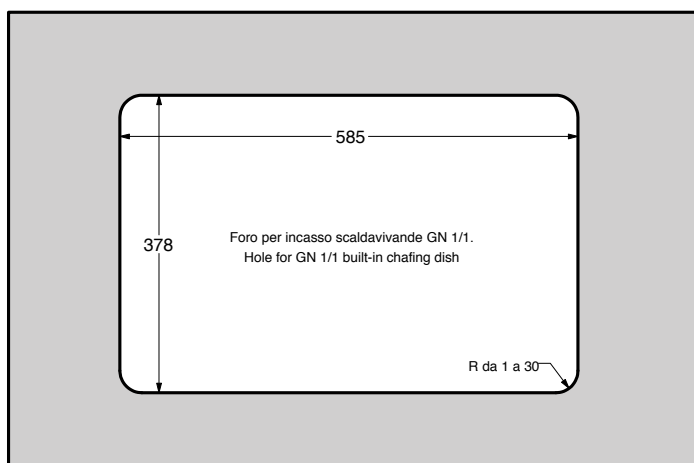





Scaldavivande GN 1/1 per supporti Urban

GN 1/1 built-in chafing dish
Chafing dish encastrable GN 1/1
Eingebautes Chafing Dish GN 1/1
Chafing dish empotrable GN 1/1

V87 18 520 02 Con coperchio in acciaio inox - With st. Steel cover
V87 18 520 03 Con coperchio in vetro - With glass cover

Predisposto per piastra elettrica. Portavivande GN 1/1 in acciaio incluso. Supporti Urban e fornelli esclusi.

Electric heating element available. With GN 1/1 Gastronorm food pan. Urban stand and burners excluded.



Coperchio GN 1/1 in acciaio inox

GN 1/1 St. Steel cover
Couvercle an acier inox GN 1/1
Edelstahldeckel GN 1/1
Tapa de acero inox GN 1/1

	H Cm	H In	
B03 05 52 665	7,2	2,3/4	Acciaio inossidabile - St. Steel
G03 05 52 679	7,2	2,3/4	Vetro - Glass



Inserto GN 1/1 acciaio inox

GN 1/1 container
Conteneur GN 1/1
Gn - Behälter 1/1
Contenedor GN 1/1

	H Cm	H In
V01 05 72 G11 B	6,5	2,1/2



Bagnomaria GN 1/1 acciaio inox

Pan
Bassine
Einsatz tief
Cubeta

	H Cm	H In
305 05 52 666	11	4,3/8



Fornelletto per scaldavivande

Chafing-dish burner
Porte brûleur pour chafing dish
Brennstoffhalter für Chafing Dish
Contenedor de combustible para chafing dish

V77 05 52 FDC Fornelletto - Burner (Venduto a parte)
B25 05 52 665 Supporto - Support



Supporto per set refrigerato

Stand for thermal set
Support pour set réfrigéré
Ständer für Thermo-Einsatz
Soporte para set refrigerado

V87 18 42 PCH7



Set refrigerato a incastro GN 1/1

GN 1/1 built-in thermal set
Set réfrigéré encastrable GN 1/1
Eingebautes Thermo-Einsatz GN 1/1
Set refrigerado empotrable GN 1/1

V87 18 520 07 Con coperchio in vetro - With glass cover

Set refrigerato GN 1/1 H7,2 Cm completo di bacinella in acciaio inox, griglia in acciaio inox, eutettici, vassoio GN 1/1 HCm 2 in acciaio inox. Supporti Urban esclusi.

Thermal set GN 1/1 H 7,2 Cm with st. Steel pan, st. Steel grid, ice packs, st. Steel tray GN 1/1 H Cm 2. Urban stand exclude



Coperchio GN 1/1 in vetro

GN 1/1 glass cover
Couverche en verre GN 1/1
Glasdeckel GN 1/1
Tapa de vidrio GN 1/1

	H Cm	H In
G03 05 52 670	7,2	2,3/4



Inserto GN 1/1 acciaio inox

GN 1/1 container
Conteneur GN 1/1
Gn - Behälter 1/1
Contenedor GN 1/1

	H Cm	H In
V01 05 72 G11	2	0,3/4



Griglia

Grid
Grille
Gittereinsatz
Reja

	H Cm	H In
B4 705 52 668	2	0,3/4



Eutettico

Ice pack
Bloc réfrigérant
Kühlakku
Acumulador de frío

V77 12 95 G00



Bacinella GN 1/1 acciaio inox

Pan
Bassine
Einsatz tief
Cubeta

	H Cm	H In
305 05 52 671	7,5	3



Supporto per set refrigerato

Stand for thermal set
Support pour set réfrigéré
Ständer für Thermo-Einsatz
Soporte para set refrigerado

V87 18 42 PCH1

Inserto GN 1/1

GN 1/1 container
 Conteneur GN 1/1
 Gn - Behälter 1/1
 Contenedor GN 1/1

Inox 18/10 - St. Steel

	Cm	H Cm	Sp. Mm
V01 05 72 G11	53x32,5	2	0,7
V01 05 72 G11 B	53x32,5	6,5	0,7

**Inserto GN 2/3**

GN 2/3 container
 Conteneur GN 2/3
 Gn - Behälter 2/3
 Contenedor GN 2/3

Inox 18/10 - St. Steel

	Cm	H Cm	Sp. Mm
V01 05 72 G23	35,4x32,5	2	0,7
V01 05 72 G23 B	35,4x32,5	6,5	0,7

**Inserto GN 1/3**

GN 1/3 container
 Conteneur GN 1/3
 Gn - Behälter 1/3
 Contenedor GN 1/3

Inox 18/10 - St. Steel

	Cm	H Cm	Sp. Mm
V01 05 72 G13	32,5x17,6	2	0,7
V01 05 72 G13 A	32,5x17,6	4	0,7

**Inserto GN 1/2**

GN 1/2 container
 Conteneur GN 1/2
 Gn - Behälter 1/2
 Contenedor GN 1/2

Inox 18/10 - St. Steel

	Cm	H Cm	Sp. Mm
V01 05 72 G12	32,5x26,5	2	0,7
V01 05 72 G12 B	32,5x26,5	6,5	0,7

**Piastra elettrica**

Electric hot plate
 Plaque électrique
 Elektrische Platte
 Placa eléctrica

V77 05 52 PCR

V77 05 52 PCR1 Con regolatore - With regulator



Inserto GN 1/1

Food pan, GN 1/1
 Conteneur GN 1/1
 Porzellanbehälter, GN 1/1
 Contenedor GN 1/1

Porcellana - Porcelain

	H Cm	H In
V01 21 52 G11B	6,5	2,1/2
V01 21 52 G11	2	0,3/4

**Inserto GN 2/3**

Food pan, GN 2/3
 Conteneur GN 2/3
 Porzellanbehälter, GN 2/3
 Contenedor GN 2/3

Porcellana - Porcelain

	H Cm	H In
V01 21 52 G23B	6,5	2,1/2

**Inserto GN 1/2**

Food pan, GN 1/2
 Conteneur GN 1/2
 Porzellanbehälter, GN 1/2
 Contenedor GN 1/2

Porcellana - Porcelain

	H Cm	H In
V01 21 52 G12B	6,5	2,1/2

**Inserto GN 1/3**

Food pan, GN 1/3
 Conteneur GN 1/3
 Porzellanbehälter, GN 1/3
 Contenedor GN 1/3

Porcellana - Porcelain

	H Cm	H In
V01 21 52 G13B	6,5	2,1/2

**Piatto piano quadrato**

Square flat plate
 Assiette carré
 Viereckig, flach
 Plato cuadrado

Porcellana - Porcelain

	Cm	H In
V01 21 42 P22	22x22	8,5/8x8,5/8







Revolution

Un'idea nuova ed originale nel concetto Buffet: **Mix&Play Revolution** consente con un tocco di creatività e fantasia di presentare cibi, bevande, stuzzichini ecc. ispirandosi ai diversi momenti di consumo (dalla colazione all'aperitivo) e alle tipologie dei locali. Un'opera d'arte che coniuga modernità e funzionalità in un prodotto che non ha eguali.

Le strutture in alluminio sono state pensate per soddisfare le differenti esigenze di spazio e di consumo del cliente. Sono l'esempio per eccellenza del concetto modulare consentendo la composizione di 5 differenti misure delle basi (2 quadrate e 3 rettangolari) per 3 differenti altezze. Con la creatività è possibile adattare **Mix&Play Revolution** Buffet al proprio spazio e creare sempre nuove ed originali presentazioni.

7 nuove composizioni studiate per facilitare la creazione del vostro buffet.

*A new and original idea for the buffet: **Mix&Play Revolution** allows to present food and beverages etc. at different times of the day and different kinds of place, with an incredible touch of creativity and fantasy. A work of art that matches modern day practicality in just one product. The only one!*

*The metal podium are created to satisfy the different needs of space and consumption. They are easy excellent example of modular concept allowing the composition of 5 different sizes of base (2 square and 3 rectangular) for 3 different heights. By being creative it is possible to adapt **Mix&Play Revolution** Buffet to any kind of space and always provide new and fantastic Buffet.*

7 new arrangements studied to make the preparation of your buffet easier.

Set 1

Set 1
Set 1
Set 1
Set 1

V86 32 42 003 Nero-Black
V86 32 42 010 Silver-Silver

Cm	H Cm	In	H In
52,5x70	24	20,5/8x27,1/2	9,1/2

**Set 2**

Set 2
Set 2
Set 2
Set 2

V86 32 42 004 Nero-Black
V86 32 42 011 Silver-Silver

Cm	H Cm	In	H In
35x70	24	13,3/4x27,1/2	9,1/2

**Set 3**

Set 3
Set 3
Set 3
Set 3

V86 32 42 005 Nero-Black
V86 32 42 012 Silver-Silver

Cm	H Cm	In	H In
52,5x70	22,5	20,5/8x27,1/2	8,7/8

**Set 4**

Set 4
Set 4
Set 4
Set 4

V86 32 42 006 Nero-Black
V86 32 42 013 Silver-Silver

Cm	H Cm	In	H In
52,5x70	22,5	20,5/8x27,1/2	8,7/8



Set 5

Set 5
Set 5
Set 5
Set 5

V86 32 42 007 Nero-Black
V86 32 42 014 Silver-Silver

Cm	H Cm	In	H In
52,5x70	16	20,5/8x27,1/2	6,1/4



Set 6

Set 6
Set 6
Set 6
Set 6

V86 32 42 008 Nero-Black
V86 32 42 015 Silver-Silver

Cm	H Cm	In	H In
52,5x52,5	16	20,5/8x20,5/8	6,1/4



Set 7

Set 7
Set 7
Set 7
Set 7

V86 32 42 009 Nero-Black
V86 32 42 016 Silver-Silver

Cm	H Cm	In	H In
52,5x52,5	16	20,5/8x20,5/8	6,1/4



Set Large

Set Large
Set Large
Set Large
Set Large

V86 32 42 L05 Nero-Black
V86 32 42 L06 Silver-Silver

Cm	H Cm	In	H In
122,5x87,5	30,5	48,1/4x34,1/2	12

**Set Small**

Set Small
Set Small
Set Small
Set Small

V86 32 42 S05 Nero-Black
V86 32 42 S08 Silver-Silver

Cm	H Cm	In	H In
87,5x52,5	26,5	34,1/2x20,5/8	10,3/8



Alzata modulare quadrata

Square modular podium
Etagère modulaire carrée
Modulständer, viereckig
Expositor modular cuadrado

	Cm	H Cm	In	H In
Argento - Silver				
V86 11 42 Q01	17,5x17,5	9,5	6,7/8x6,7/8	3,3/4
V86 11 42 Q02	17,5x17,5	16	6,7/8x6,7/8	6,1/4
V86 11 42 Q03	17,5x17,5	22,5	6,7/8x6,7/8	8,7/8
Nero - Black				
V86 15 42 Q01	17,5x17,5	9,5	6,7/8x6,7/8	3,3/4
V86 15 42 Q02	17,5x17,5	16	6,7/8x6,7/8	6,1/4
V86 15 42 Q03	17,5x17,5	22,5	6,7/8x6,7/8	8,7/8



Alzata modulare quadrata

Square modular podium
Etagère modulaire carrée
Modulständer, viereckig
Expositor modular cuadrado

	Cm	H Cm	In	H In
Argento - Silver				
V86 11 42 Q04	35x35	9,5	13,3/4x13,3/4	3,3/4
V86 11 42 Q05	35x35	16	13,3/4x13,3/4	6,1/4
V86 11 42 Q06	35x35	22,5	13,3/4x13,3/4	8,7/8
Nero - Black				
V86 15 42 Q04	35x35	9,5	13,3/4x13,3/4	3,3/4
V86 15 42 Q05	35x35	16	13,3/4x13,3/4	6,1/4
V86 15 42 Q06	35x35	22,5	13,3/4x13,3/4	8,7/8



Alzata modulare rettangolare

Rectangular modular podium
Etagère modulaire rectangulaire
Modulständer, rechteckig
Expositor modular rectangular

	Cm	H Cm	In	H In
Argento - Silver				
V86 11 42 R01	17,5x35	9,5	6,7/8x13,3/4	3,3/4
V86 11 42 R02	17,5x35	16	6,7/8x13,3/4	6,1/4
V86 11 42 R03	17,5x35	22,5	6,7/8x13,3/4	8,7/8
Nero - Black				
V86 15 42 R01	17,5x35	9,5	6,7/8x13,3/4	3,3/4
V86 15 42 R02	17,5x35	16	6,7/8x13,3/4	6,1/4
V86 15 42 R03	17,5x35	22,5	6,7/8x13,3/4	8,7/8



Alzata modulare rettangolare

Rectangular modular podium
Etagère modulaire rectangulaire
Modulständer, rechteckig
Expositor modular rectangular

	Cm	H Cm	In	H In
Argento - Silver				
V86 11 42 R04	17,5x52,5	9,5	6,7/8x20,5/8	3,3/4
V86 11 42 R05	17,5x52,5	16	6,7/8x20,5/8	6,1/4
V86 11 42 R06	17,5x52,5	22,5	6,7/8x20,5/8	8,7/8
Nero - Black				
V86 15 42 R04	17,5x52,5	9,5	6,7/8x20,5/8	3,3/4
V86 15 42 R05	17,5x52,5	16	6,7/8x20,5/8	6,1/4
V86 15 42 R06	17,5x52,5	22,5	6,7/8x20,5/8	8,7/8



Alzata modulare rettangolare

Rectangular modular podium
Etagère modulaire rectangulaire
Modulständer, rechteckig
Expositor modular rectangular

	Cm	H Cm	In	H In
Argento - Silver				
V86 11 42 R07	35x52,5	9,5	13,3/4x20,5/8	3,3/4
V86 11 42 R08	35x52,5	16	13,3/4x20,5/8	6,1/4
V86 11 42 R09	35x52,5	22,5	13,3/4x20,5/8	8,7/8
Nero - Black				
V86 15 42 R07	35x52,5	9,5	13,3/4x20,5/8	3,3/4
V86 15 42 R08	35x52,5	16	13,3/4x20,5/8	6,1/4
V86 15 42 R09	35x52,5	22,5	13,3/4x20,5/8	8,7/8



Piano legno quadrato

Square wooden base
 Tablette en bois carrée
 Holzplatte, viereckig
 Tablero de madera cuadrado

	Cm	H Cm	In	H In
V86 04 42 PQ1	17,5x17,5	0,8	6,7/8x6,7/8	0,3/8

**Piano legno rettangolare**

Rectangular wooden base
 Tablette en bois rectangulaire
 Holzplatte, rechteckig
 Tablero de madera rectangular

	Cm	H Cm	In	H In
V86 04 42 PR1	17,5x35	0,8	6,7/8x13,3/4	0,3/8

**Supporto legno inclinato quadrato**

Square modular podium
 Étagère modulaire carrée
 Holzgestell, viereckig, schräg gestellt
 Expositor modular cuadrado

	Cm	H Cm	In	H In
V86 04 42 SQ1	35x35	7,5	13,3/4x13,3/4	3

**Supporto legno inclinato rettangolare**

Rectangular modular podium
 Étagère modulaire rectangulaire
 Holzgestell, viereckig, schräg gestellt
 Expositor modular rectangular

	Cm	H Cm	In	H In
V86 04 42 SR1	35x52,5	7,5	13,3/4x20,5/8	3



Vassoio legno quadrato

Square wooden tray
 Plateau en bois carrée
 Holztablett, viereckig
 Bandeja de madera cuadrado

	Cm	H Cm	In	H In
V86 04 42 VQ1	35x35	4	13,3/4x13,3/4	1,1/2
V86 04 42 VQ2	35x35	8	13,3/4x13,3/4	3,1/8



Vassoio legno rettangolare

Rectangular wooden tray
 Plateau en bois rectangulaire
 Holztablett, rechteckig
 Bandeja de madera rectangular

	Cm	H Cm	In	H In
V86 04 42 VR1	17,5x35	4	6,7/8x13,3/4	1,1/2
V86 04 42 VR2	17,5x35	8	6,7/8x13,3/4	3,1/8



Vassoio legno rettangolare

Rectangular wooden tray
 Plateau en bois rectangulaire
 Holztablett, rechteckig
 Bandeja de madera rectangular

	Cm	H Cm	In	H In
V86 04 42 VR3	17,5x52,5	4	6,7/8x20,5/8	1,1/2
V86 04 42 VR4	17,5x52,5	8	6,7/8x20,5/8	3,1/8



Vassoio legno rettangolare

Rectangular wooden tray
 Plateau en bois rectangulaire
 Holztablett, rechteckig
 Bandeja de madera rectangular

	Cm	H Cm	In	H In
V86 04 42 VR5	35x52,5	4	13,3/4x20,5/8	1,1/2
V86 04 42 VR6	35x52,5	8	13,3/4x20,5/8	3,1/8



Piatto quadrato porcellana

Square porcelain platter
 Plat carré en porcelaine
 Porzellanteller, viereckig
 Plato cuadrado de porcellana

	Cm	In
V86 21 42 PQP	17,5x17,5	6,7/8x6,7/8

**Piatto quadrato porcellana**

Square porcelain platter
 Plat carré en porcelaine
 Porzellanteller, viereckig
 Plato cuadrado de porcellana

	Cm	In
V86 21 42 PQG	35x35	13,3/4x13,3/4

**Piatto rettangolare porcellana**

Rectangular porcelain platter
 Plat rectangulaire en porcelaine
 Porzellanteller, rechteckig
 Plato rectangular de por

	Cm	In
V86 21 42 PRE	17,5x35	6,7/8x13,3/4

**Teglia rettangolare in porcellana**

Rectangular porcelain baker
 Plate a roti rectangular en porcelaine
 Porzellanbackform, rechteckig
 Fuente rectangular porcelana

	Cm	In
V86 21 42 TRE	17,5x35	6,7/8x13,3/4

**Teglia quadrata in porcellana**

Square porcelain baker
 Plate a roti carré en porcelaine
 Porzellanbackform, viereckig
 Fuente cuadrada de porcelana

	Cm	In
V86 21 42 TQU	35x35	13,3/4x13,3/4



Ciotola quadra porcellana

Porcelain bowl
Bol carré en porcelaine
Porzellanschale, viereckig
Bol cuadrado de porcellana

	Cm	H Cm	In	H In
V86 21 42 CQ14	14x14	8	5,1/2x5,1/2	3,1/8



Ciotola quadra porcellana

Porcelain bowl
Bol carré en porcelaine
Porzellanschale, viereckig
Bol cuadrado de porcellana

	Cm	H Cm	In	H In
V86 21 42 CQ7	7x7	3,5	2,3/4x2,3/4	1,3/8



Bicchieri vetro basso

Glass glass, small
Verre Ginco
Glass, klein
Vaso cristal bajo

	ø Cm	H Cm	Lt
V86 08 42 BBA	6	8	0,10
	ø In	H In	Oz
	2,3/8	3,1/8	3,5



Bicchieri vetro alto

Glass glass, tall
Verre en verre haut
Glass, hoch
Vaso cristal alto

	ø Cm	H Cm	Lt
V86 08 42 BAL	7	11	0,15
	ø In	H In	Oz
	2,3/4	4,3/8	5



Coppa in vetro

Glass bowl
Coupelle en verre
Glasschale
Bol de vidrio

	ø Cm	H Cm	ø In	H In
V86 08 42 C12	12	7	4,3/4	2,3/4



Set ABS

Set 1

Set 1

Set 1

Set 1

	Cm	H Cm	In	H In
V86 32 42 S06 Nero-Black	87x52,5	23	34,1/4x20,5/8	9
V86 32 42 S07 Silver-Silver	87x52,5	23	34,1/4x20,5/8	9



Piano in ABS nero quadrato liscio

Square plain black ABS base

Plat carré en abs noir

ABS Platte, schwarz viereckig und glatt

Base en ABS negra cuadrada lisa

	Cm	In
V86 12 42 QLI 15	17,5x17,5	6,7/8x6,7/8

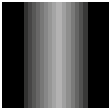
**Piano in ABS nero rettangolare liscio**

Rectangular plain black ABS base

Plat rectangulaire en ABS noir

ABS Platte, schwarz rechteckig und glatt

Base en ABS negra cuadrada lisa

	Cm	In
V86 12 42 RLI 15	17,5x35	6,7/8x13,3/4

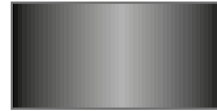
**Piano abs nero quadrato 1 foro grande**

Square Abs base with 1 hole

Plat carré en abs noir 1 trou grand

ABS Platte, schwarz mit einem Loch

Base en ABS negra con 1 agujero grande

	Cm	In
V86 12 42 Q1F 15	17,5x17,5	6,7/8x6,7/8

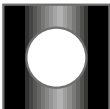
**Piano abs nero rettangolare 2 fori grandi**

Rectangular Abs base with 2 holes

Plat rectangulaire en ABS noir 2 trous grands

ABS Platte, schwarz rechteckig und mit 2 großen Löcher

Base en ABS negra rectangular, con 2 agujeros grandes

	Cm	In
V86 12 42 R2F 15	17,5x35	6,7/8x13,3/4

**Piano abs nero quadrato 4 fori piccoli**

Square Abs base with 4 holes

Plat carré en ABS noir 4 trous petits

ABS Platte, schwarz viereckig mit 4 kleinen Löcher

Base en ABS negra cuadrada con 4 agujeros pequeños

	Cm	In
V86 12 42 Q4F 15	17,5x17,5	6,7/8x6,7/8

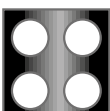
**Piano abs nero rettangolare 8 fori piccoli**

Rectangular Abs base with 8 holes

Plat rectangulaire en ABS noir 8 trous petits

ABS Platte, schwarz viereckig mit 8 kleinen Löcher

Base en ABS negra rectangular, con 8 agujeros pequeños

	Cm	In
V86 12 42 R8F 15	17,5x35	6,7/8x13,3/4

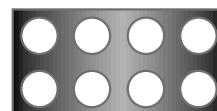

Distributore succhi

Juice dispenser
Distributeur jus
Saftdispenser
Dispensador de zumo

**Con rubinetto in metallo**

With metal tap
Avec robinet en métal
Mit Metallhahn
Con grifo de metal

	Lt	Oz	Cm	H Cm	In	H In
V76 05 52 00 8R	3,5	118	20x31,5	51	7,3/4x12,1/2	20
V76 05 52 00 2R	7	237	27x37	56	10,5/8x14,1/2	22
V76 05 52 01 2R	12	405	27x37	51	10,5/8x14,1/2	20

**Con rubinetto in plastica**

With plastic tap
Avec robinet en plastique
Mit Kunststoffhahn
Con grifo de plástico

	Lt	Oz	Cm	H Cm	In	H In
V76 05 52 00 9R	3,5	118	20x31,5	51	7,3/4x12,1/2	20
V76 05 52 00 3R	7	237	27x37	56	10,5/8x14,1/2	22
V76 05 52 01 3R	12	405	27x37	51	10,5/8x14,1/2	20

**Portaformaggi-affettati rettangolare refrigerato**

Thermal rectangular cheese dish
Plateau fromage - charcuterie rectangulaire réfrigérant
Rechteckige Aufschnittplatte, gekühlt
Quesera rectangular refrigerante

	Cm	H Cm	In	H In
V76 05 54 R0 1R	50x30	20	19,3/4x11,3/4	7,7/8





Distributore caffè

Coffee urn
Distributeur de café
Kaffeedispenser
Dispensador de café

	Lt	Cm	HCm
V76 05 52 00 1R	10	26x33	64
	Oz	In	H In
	350	10,1/4x13	25,1/8

Distributore cereali singolo

Cereal dispenser
Distributeur céréales
Müeslidispenser
Dispensador de cereales

	Lt	Cm	HCm
V76 05 52 01 0R	4	19,5x29	56
	Oz	In	H In
	135	7,3/4x11,3/8	22

	Lt	Cm	HCm
V76 05 52 01 1R	7	19,5x29	70
	Oz	In	H In
	237	7,3/4x11,3/8	27,7/8





BUFFET SQUARE

Portaformaggi-affettati rettangolare refrigerato Square

Thermal rectangular cheese dish Square

Plateau fromage-charcuterie rectangulaire réfrigérant Square

Rechteckige Aufschnittplatte, gekühlt, Square

Quesera rectangular refrigerante Square

Inox 18/10 - St. Steel

	Cm	H Cm	In	H In
V76 05 54 R01	50x30	20	19,5/8x11,7/8	7,7/8



Coperchio a bascula rettangolare trasparente

Transparent rectangular rolltop cover

Cloche basculante rectangulaire transparente

Rolltophaube-rechteckig

Campana rectangular transparente

SAN

	Cm	In
V76 12 15 R01	47x27	18,1/2x10,5/8

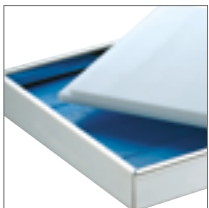

Tagliere rettangolare

Rectangular cutting board

Planche à découper rectangulaire

Rechteckiges Schneidebrett

Tabla de cortar rectangular

Polietilene

	Cm	In
V77 12 71 R01	47x27	18,1/2x10,5/8



4 Eutettici rettangolari

4 Ice packs

4 Blocs réfrigérants

4 Kühlakkus

4 Acumuladores de frío rectangulares

V77 12 95 M00

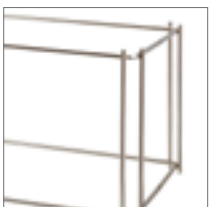

Alzata filo per basi rettangolari

Square wire stand for rectangular bases

Support en fil pour bases rectangulaires

Drahtständer für rechteckigen Sockel

Soporte filo de acero para bases rectangulares

Inox 18/10 - St. Steel

	Cm	H Cm
V76 05 42 001	50x30	27,5

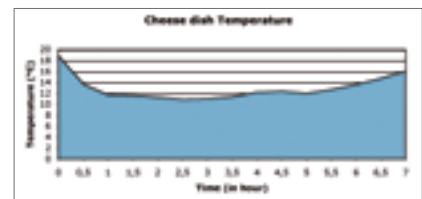

Temperatura ambiente
External temperature 19,6°

Temperatura acqua
Water temperature 18,9°

Mezzo refrigerante
Cooler system 8 eutettici ghiaccio piccoli
8 small ice packs

Portaformaggi-affettati tondo refrigerato Square

Thermal round cheese dish Square

Plateau fromage-charcuterie rond réfrigérant Square

Runde Aufschnittplatte, gekühlt, Square

Quesera redonda refrigerante Square

Inox 18/10 - St. Steel

	Cm	H Cm	In	H In
V76 05 54 T01	38x38	23	14,8/8x14,8/8	9



Coperchio a bascula tondo trasparente

Transparent round rolltop cover

Cloche basculante ronde transparente

Rolltophaube - rund

Campana redonda transparente

SAN

	ø Cm	ø In
V76 12 15 T01	34	13,3/8



Tagliere quadrato con scanal. tonda

Square cutting board with round groove

Planche à découper carrée avec rainure ronde

Viereckiges Schneidebrett mit runder Rille

Tabla de cortar cuadrada con ranura

Polietilene

	Cm	In
V77 12 71 T01	35x35	13,3/4x13,3/4



Eutettici rettangolari

Ice packs

Blocs réfrigérants

Kühlakkus

Acumuladores de frío rectangulares

V77 12 95 M00

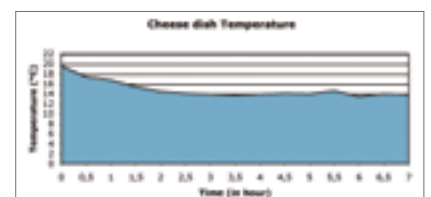

Temperatura ambiente External temperature 20,9°

Temperatura acqua Water temperature 19,5°

Mezzo refrigerante Cooler system 4 eutettici ghiaccio piccoli
4 small ice packs

Distributore succhi Square

Square juice dispenser

Distributeur jus Square

Saftdispenser Square

Dispensador de zumo Square

**Con rubinetto in metallo**

With metal tap

Avec robinet en métal

Mit Metallhahn

Con grifo de metal

	Cm	H Cm	Lt	Oz
V76 05 52 008	18x27,5	46	3,5	118
V76 05 52 002	24x31	50	7	237
V76 05 52 012	24x31	70	12	405

**Con rubinetto in plastica**

With plastic tap

Avec robinet en plastique

Mit Kunststoffhahn

Con grifo de plástico

	Cm	H Cm	Lt	Oz
V76 05 52 009	17,5x27,5	41	3,5	118
V76 05 52 003	23,5x31	50	7	237
V76 05 52 013	23,5x31	78	12	405

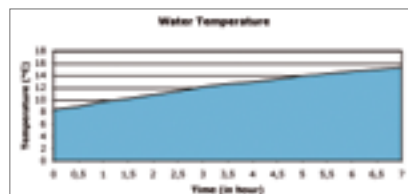

Temperatura ambiente
External temperature 20,0°

Temperatura acqua
Water temperature 7,6°

Quantità acqua inserita
Quantity of water added 7 Lt

Distributore caffè Square

Coffee urn 10 Lt
 Distributeur de café 10 Lt
 Kaffeedispenser 10 Lt
 Dispensador de café 10 Lt

	Cm	H Cm	Lt	Oz
V76 05 52 001	24x31	61	10	350



Fornelletto per scaldavivande / distributore caffè

Burner for chafing dish/coffee urn
 Porte bruleur pour chafing dish et distributeur café
 Brennstoffhalter für Chafing Dish und Kaffeedispenser
 Contenidor de combustible para chafing dish - dispensador de café

V77 05 52 FDC



Piastra elettrica per distributore caffè

Heating element for coffee urn
 Plaque électrique pour distributeur de café
 Elektro-Heizelement für Kaffeedispenser
 Plancha eléctrica para dispensador de caf

	ø Cm	ø In
V77 05 52 PDC	14	5,1/2

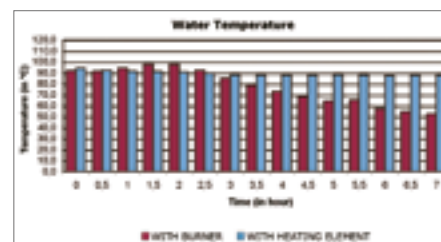

Temperatura ambiente
 External temperature 20,0°

Temperatura acqua
 Water temperature 92,5°/98,8°

Quantità acqua inserita
 Quantity of water added 8 Lt

Distributore cereali singolo Square

Square cereal dispenser

Distributeur céréales Square

Mueslidispenser Square

Dispensador de cereales Square

	Cm	H Cm	Lt	Oz
V76 05 52 010	18x27	53	4	135
V76 05 52 011	18x27	68	7	237



Tagliere per pane base acciaio Square

Square bread cutting board with St. Steel base
 Planche à découper à pain Square avec base en acier inoxydable
 Brotschneidebrett Square mit Stahlgestell
 Tabla de cortar pan Square con base de acero inoxidable

	Cm	In
V76 05 54 001	50x30	19,5/8x11,7/8
V76 04 71 001	50x30	19,5/8x11,7/8

Solo tagliere

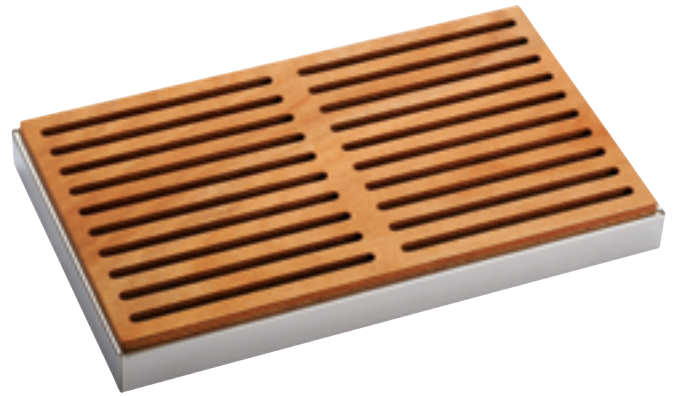

Cestino pane acciaio per buffet Square

Square bread basket for buffet, St. Steel
 Corbeille à pain en acier pour buffet Square
 Brotkorb Square für Buffet, Edelstahl
 Cesta pan en acero para buffet Square

	Cm	In
V76 05 24 001	50x30	19,5/8x11,7/8



Scaldabrioche Square con termostato

Square croissant warmer
 Chauffe - croissants Square
 Croissantwärmer Square
 Calentador croissants Square

	Cm	In
V76 05 52 020	47,5x28	18,3/4x11



Portamacedonia Square

Square yogurt/fruit-salad holder without lid
 Porte-salade de fruits/yogourt sans couvercle Square
 Joghurt/Obstsalatbehälter ohne Deckel Square
 Porta yogur/ensalada de frutas refrigerado sin tapa Square

	Cm	In
V76 05 52 017	24x24	6,7/8x6,7/8

Con coperchio - with lid

V76 05 52 007	24x24	6,7/8x6,7/8
---------------	-------	-------------

Senza coperchio - without lid

**Coperchio metacrilato c/pomolo Square**

Acrylic lid with knob Square
 Couvercle acrylique avec pommeau Square
 Deckel aus Acryl mit Knopf Square
 Tapa acrílica con perilla Square

310 12 15 797

**Ciotola in vetro**

Glass bowl
 Bol en verre
 Glasschale
 Bol de vidrio

	ø Cm	ø In
310 08 42 527	23	9

**Disco copri eutettici**

Ice pack cover
 Disc pour blocs réfrigérants
 Disco para acumuladores de frío
 Kühlakkus Scheibe

	ø Cm	ø In
Z76 60 52 007	24	9,1/2

**Eutettici rettangolari**

Ice packs
 Blocs réfrigérants
 Kühlakkus
 Acumuladores de frío rectangulares

V77 12 95 M00

Contenitore in metallo porta macedonia /eutettico Square

Square metal fruit salad holder 24x24 Cm w/o ice pack
 Conteneur en métal pour salade de fruits sans bloc réfrigérant Square
 Metalbehälter ohne Kühlakkus Square
 Porta ensalada de frutas en metal Square sin acumuladore de frío

Z76 20 52 007



Portayogurt/marmellata refrigerato Square

Square thermal yogurt/jam holder for pitcher
 Rafrâchisseur yaourt/confiture Square
 Joghurt/Marmeladebehälter, gekühlt Square
 Portayogurt/mermelada refrigerado Square

	∅ Cm	∅ In
V76 05 52 014	15	6

Con coperchio - with lid

V76 05 52 004	15	6
---------------	----	---

Senza coperchio - without lid



Coperchio porta yogurt c/pomolo Square

Square lid with knob for yogurt holder
 Couvercle sans pomole pour porte-yaourt Square
 Deckel für Joghurtbehälter Square
 Tapa para portayogur sin perilla Square

	∅ Cm	∅ In
Z76 01 52 004	4	1,1/2



Ciotola in vetro

Glass bowl
 Bol en verre
 Glasschale
 Bol en vidrio

	∅ Cm	∅ In	Lt	Oz
V76 08 52 004	15	6	0,5	17



Disco copri eutettici

Ice pack cover
 Disc pour blocs réfrigérants
 Kühlakku Scheibe
 Disco para acumuladores de frío

	∅ Cm	∅ In
Z76 60 52 005	15	6



Eutettici tondi

Round ice packs
 Blocs réfrigérants ronds
 Kühlakku, rund
 Acumuladores de frío rectangulares

	∅ Cm	∅ In
V77 12 95 T01	14,5	5,3/4



Contenitore in metallo porta caraffe/yogurt s/eutettico Square

Square pitcher/yogurt holder without ice pack
 Conteneur en métal pour carafes/yaourt sans bloc réfrigérant Square
 Metalbehälter ohne Kühlakku Square
 Portayogurt/jarra sin acumulador de frío Square

	Cm	H Cm	In	H In
Z76 20 52 004	17,5x17,5	7	6,7/8x6,7	3,3/4



Portacaraffa con coperchio refrigerato Square

Square thermal pitcher holder with lid
 Porte-carafe avec couvercle réfrigérant Square
 Karaffenträger mit Deckel, gekühlt Square
 Soporte refrigerado para jarra con tapa Square

	Lt	Oz
V76 05 52 005	1,5	50

Con coperchio-with lid

V76 05 52 006	1,5	50
---------------	-----	----

Senza coperchio-without lid

**Coperchio caraffa in acciaio per brocca**

St. Steel lid for juice pitcher
 Couvercle en acier pour carafe
 Edelstahl Deckel für Karaffe
 Tapa en acero para jarra

	∅ Cm	∅ In
Z76 01 52 005	10	4

**Caraffa vetro**

Glass pitcher
 Carafe en verre
 Saftkanne
 Jarra de zumo

	Lt	Oz
V76 08 52 009	1,5	50

Senza coperchio-without lid

V76 08 52 005	1,5	50
---------------	-----	----

Con coperchio-with lid

**Disco copri eutettici**

Ice pack cover
 Disc pour blocs réfrigérants
 Kühlakkus Scheibe
 Disco para acumuladores de frío

	∅ Cm	∅ In
Z76 60 52 005	15	6

**Eutettici tondi**

Round ice packs
 Blocs réfrigérants ronds
 Kühlakkus, rund
 Acumuladores de frío rectangulares

	∅ Cm	∅ In
V77 12 95 T01	14,5	5,3/4

**Contenitore in metallo porta caraffe/yogurt s/eutettico Square**

Square pitcher/yogurt holder w/o ice pack
 Conteneur en métal pour carafes/yaourt sans bloc réfrigérant Square
 Metalbehälter ohne Kühlakkus Square
 Portayogurt/jarra sin acumulador de frío Square

	Cm	H Cm	In	H In
Z76 20 52 004	17,5x17,5	7,5	6,7/8x6,7	3



Portacaraffe con sistema refrigerante

Thermal pitcher 4-pc set
 Rafrâchisseur à 4 carafes
 Thermo-Karaffenhalter 4 Stck.
 Enfriador para 4 jarras

Inox 18/10 - St. Steel

	Cm	H Cm	In	H In
V76 05 52 021	24x24	7,5	9,1/2x9,1/2	3

Caraffe non incluse - Water jugs not included



Caraffa acqua con coperchio basculante

Water glass pitcher with smart lid
 Carafe en verre avec couvercle basculant
 Wasserkaraffe
 Jarra de vidrio con tapa basculante

	Lt	Oz
● V76 08 52 007	1	35
● V76 08 52 007 35	1	35
● V76 08 52 007 07	1	35

Rinfresca caraffe con sistema refrigerante

Thermal pitcher
 Rafrâchisseur à carafes
 Thermo-Karaffenhalter
 Enfriador de botallas

Inox 18/10 - St. Steel

	ø Mm	H Cm	ø In	H In
V76 055 20 23	135	5	5,3/8	2

con eutettico - with ice pack
 caraffa esclusa - without pitcher

**Eutettico per rinfresca caraffe**

Ice pack for thermal pitcher
 Bloc réfrigérant pour rafraîchisseur à carafes
 Kühlelemente für Thermo-Karaffenhalter
 Acumulador de frío para enfriador de botellas

Polietilene - Polyethylene

	ø Mm	H Cm	ø In	H In
V77 12 95 T02	75	2,5	3	1

**Corpo per porta caraffa**

Container for thermal pitcher
 Conteneur pour rafraîchisseur à carafes
 Behälter für Thermo-Karaffenhalter
 Contenedor para enfriador de botellas

Polietilene - Polyethylene

	ø Mm	H Cm	ø In	H In
Z76 20 52 023	135	5	5,3/8	2



Contenitore alto per struttura piramidale

Container for pyramid buffet system
Conteneur haut pour structure pyramidale
Behälter für pyramidal Gestell
Contenedor alto para estructura piramidal

	Cm	H Cm	In	H In
V76 05 23 006	7x9,5	6	2,3/4x3,3/4	2,3/8



Cucchiaino appetizer tondo

Appetizer curved spoon
Cuillère de mise en bouche ronde pliée
Appetizer - rund gebogener Löffel
Cuchara aperitivo redonda plegada

Inox 18/10 - St. Steel

	Cm	In
903 05 81 APC	140	5,1/2



Ciotola porcellana quadra

Porcelain square bowl
Bol carré en porcelaine
Porzellanschale, viereckig
Bol cuadrado en porcelana

	Cm	In
V86 21 42 CQ7	7x7	2,3/4x2,3/4



Bicchieri

Glass
Verre
Glas
Vaso

	ø Cm	H Cm	ø In	H In
V86 08 42 BBA	5,5	7	2,1/8	2,3/4



Struttura piramidale

completa di 5 ripiani e 3 contenitori alti.

Pyramid buffet system including 5 bases and 3 containers
Structure pyramidale complète avec 5 bases e 3 conteneurs
Pyramidal Gestell komplet bestehend von 5 Fächer und 3 hoch Behälter
Estructura piramidal completa con 5 bases y 3 contenedores

	Cm	H Cm	In	H In
V76 05 42 006	29,5x36,5	50	11,3/4x14,1/2	19,3/4



Piano rettangolare per struttura piramidale

Rectangular base for pyramid buffet system
Plan rectangulaire pour structure pyramidale
Rechteckig Fach für pyramidal Gestell
Base rectangular para estructura piramidal

	Cm	In
V76 05 23 005	29,5x7	11,5/8x2,3/4





Un oggetto **elegante e contemporaneo**, adatto a ogni tipo di buffet: grazie al design unico e innovativo.

I materiali usati sono di **alto livello qualitativo** - acciaio inox 18/10 e metacrilato - e rendono il distributore un oggetto pregiato.

MADE IN ITALY

La **tecnologia semplice**, ma al tempo stesso funzionale, permette di erogare dosi da 8gr (0.28 oz) di prodotto, riducendo gli sprechi ed eliminando le monoporzioni da 25gr (0.88 oz).

Questo consente un risparmio di prodotto e la riduzione dei rifiuti

nel rispetto dell'ambiente. Inoltre è ideale per servire miele e marmellate di produzione artigianale, per fornire un prodotto di alto livello e che soddisfi anche i clienti più esigenti.

Un ottimo modo per arricchire l'esperienza della colazione, mantenendo **ordinato e pulito** il buffet.

Utilizzabile con prodotti erogabili semisolidi, come confetture, marmellate - pure con piccoli frammenti di frutta - e creme, ma anche con miele, sciroppi e salse di analoga consistenza.

Jambee è l'ideale per **ogni struttura ricettiva**: alberghi, pasticcerie, bar e ristoranti.



An **elegant and modern** object for all buffets, thanks to its unique and innovative design.

The materials used are **high quality** – 18/10 stainless steel and methacrylate – which makes the dispenser a fine object.

MADE IN ITALY

Its **simple technology**, though functional, allows to dispense 8 gr (0.28 oz) product doses, to reduce waste and get rid of 25 gr (0.88 oz) single dose jars.

That allows, as well, to save on product and reduce waste, respecting the environment.

Moreover, it is the ideal to dispense honey and homemade jams, in order to supply for a high-end product, capable of meeting even the most demanding customers' needs.

The best way to make the most of the breakfast experience, keeping the buffet **tidy and clean**.

It can be used with dispensable semisolid products like preserves, marmalades – even with small fruit pieces in them – , creams and honey, syrups and sauces as well, which have the same consistency. Jambee is the ideal for **any accommodation facility**: hotels, pastry shops, bars and restaurants.

**Pistone con coperchio**

Piston with lid
Piston avec couvercle
Kolben mit Deckel
Pistón con tapa

Inox 18/10, Metacrilato e PP - St. Steel, Methacrylate and PP

Z77 9852 DMA

Contenitore

Container
Conteneur
Behälter
Contenedor

Metacrilato - Methacrylate

Z77 2052 DMA

Tappo

Cap
Capsule
Stöpsel
Tapón

Metacrilato - Methacrylate

Z77 1352 DMA

Contenitore completo

Complete container
Conteneur complet
Komplett Behälter
Contenedor completo

Metacrilato - Methacrylate

Z77 9952 DMA

**Salvagoccia**

Drip catcher
Anti-goutte
Verschluß mit Tropfschutz
Antigoteo

Inox 18/10 - St. Steel

Z77 6052 DMA

**Targhetta porta etichetta**

Label plate
Plaque porte-étiquette
Schild Etikettenhalter
Placa porta etiqueta

Metacrilato - Methacrylate

Z77 5752 DMA

Jambee

Jambee
Jambee
Jambee
Jambee

Acciaio inox 18/10 - St. Steel

	Lt	Oz	Cm	In
V77 0552 DMA	0,7	24	12,5x34,5 H Min 41,5 H Max 52,5	5x13,5/8 H Min 16,3/8 H Max 20,5/8



Erogatore a siringa

Syringe nozzle
Embout seringue
AusgieBerspritze
Boquilla jeringa

Inox 18/10 - St. Steel

Z77 4652 DMA



Erogatore standard

Standard nozzle
Embout standard
Standard AusgieBer
Boquilla estandar

Inox 18/10 - St. Steel

Z77 4552 DMA





Portaformaggi/affettati rettangolare completo

Rectangular cheese dish

Plateau fromage-charcuterie rectangulaire

Käse/Wurstwarenplatte - rechteckig

Quesera rectangular

	Cm	H Cm	In	H In
V77 05 54 G11	53x32,5	18	20,7/8x12,3/4	7

**Coperchio a bascula trasparente**

Transparent rolltop cover

Cloche basculante transparente

Rolltophaube

Campana rolltop transparente

	Cm	In
V77 12 15 G11	47x27	18,1/2x10,5/8

**Vassoio gastronorm**

Gastronorm tray

Plateau gastronorm

Gastronorm Platte

Bandeja gastronorm

	Cm	In
V01 05 23 G11	53x32,5	20,7/8x12,3/4

**Tagliere rettangolare**

Rectangular cutting board

Planche rectangulaire

Rechteckig-Schneidebrett

Tabla para cortar rectangular

Polietilene

	Cm	In	Sp. Mm	Th. In
V77 12 71 G11	47x27	18,1/2x10,5/8	1,5	0,5/8

Portaformaggi/affettati tondo completo

Round cheese dish

Plateau fromage-charcuterie rond

Käse/Wurstwarenplatte - rund

Quesera redonda

	∅ Cm	H Cm	∅ In	H In
V77 05 54 T46	46	24,5	18,1/8	9,5/8



Coperchio a bascula tondo trasparente

Transparent round rolltop cover

Cloche basculante ronde transparente

Rolltophaube - rund

Campana rolltop redonda transparente

	∅ Cm	∅ In
V77 12 15 T46	41	16,1/8



Vassoio tondo bar

Round bar tray

Plateau rond bar

Platte - rund

Bandeja redonda bar

	∅ Cm	∅ In
V01 05 23 T46	46 Cm	18,1/8



Tagliere tondo

Round cutting board

Planche ronde

Schneidebrett - rund

Tabla para cortar redonda

Polietilene

	Cm	In	Sp. Mm	Th. In
V77 12 71 T46	41	16,1/8	2	0,3/4

Portaformaggi/affettati rettangolare completo refrigerato con base in acciaio

Thermal rectangular cheese dish

Plateau fromage-charcuterie rectangulaire réfrigéré

Käse/Wurstwarenplatte - rechteckig

Quesera rectangular refrigerante

	Cm	H Cm	In	H In
V77 05 54 G11 R	53x32,5	19	20,7/8x12,3/4	7,1/2

**Coperchio a bascula rettangolare trasparente**

Transparent rectangular rolltop cover

Cloche basculante rectangulaire transparente

Rolltophaube-rechteckig

Campana rectangular transparente

	Cm	In
V77 12 15 G11	47x27	18,1/2x10,5/8

**Tagliere rettangolare**

Rectangular cutting board

Planche à découper rectangulaire

Rechteckiges Schneidebrett

Tabla de cortar rectangular

Polietilene

	Cm	In	Sp. Mm	Th. In
V77 12 71 G11	47x27	18,1/2x10,5/8	1,5	0,5/8

**Bacinella rettangolare**

Rectangular pan

Cuvette rectangulaire

Schüssel - rechteckig

Cubeta rectangular

	Cm	H Cm	In	H In
V77 05 14 G11	53x32,5	3,5	20,7/8x12,3/4	1,1/8

**8 Eutettici rettangolari**

8 Ice packs

8 Blocs réfrigérants

8 Kühlakkus

8 Acumuladores de frío rectangulares

V77 12 95 P00

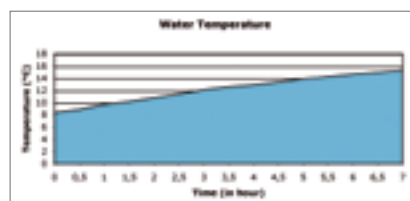

Temperatura ambiente
External temperature 19,6°

Temperatura acqua
Water temperature 18,9°

Mezzo refrigerante
Cooler system 8 eutettici ghiaccio piccoli
8 small ice pack

Portaformaggi/affettati tondo completo refrigerato con base in acciaio

Thermal round cheese dish

Plateau fromage-charcuterie rond réfrigéré

Käse/Wurstwarenplatte - rund

Quesera redonda refrigerante

	Cm	H Cm	In	H In
V77 05 54 T46 R	46	27,5	18,1/8	10,7/8



Coperchio a bascula tondo trasparente

Transparent round rolltop cover

Cloche basculante ronde transparente

Rolltophaube - rund

Campana redonda transparente

	∅ Cm	∅ In
V77 12 15 T46	41	16,1/8



Tagliere tondo

Round cutting board

Planche ronde

Schneidebrett - rund

Tabla para cortar redonda

Polietilene

	Cm	In	Sp. Mm	Th. In
V77 12 71 T46	41	16,1/8	2	0,3/4



Bacinella tonda

Round pan

Cuvette ronde

Schüssel - rund

Cubeta redonda

	∅ Cm	H Cm	∅ In	H In
V77 05 14 T46	46	5	18,1/8	2



4 Eutettici rettangolari

4 Ice packs

4 Blocs réfrigérants

4 Kühlakkus

4 Acumuladores de frío rectangular

V77 12 95 G00

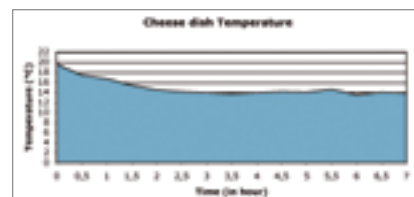

Temperatura ambiente
External temperature

20,9°

Temperatura acqua
Water temperature

19,5°

Mezzo refrigerante
Cooler system

4 eutettici ghiaccio piccoli
4 small ice pack

BUFFET IMPERIAL

Scaldavivande rettangolare con coperchio rotante

Rectangular rolltop chafing dish

Chafing dish rectangulaire avec couvercle pivotant

Chafing Dish - rechteckig mit Rolltophaube

Calientaplatos rectangular con campana

	GN	Cm	H Cm	In	H In
V77 05 52 CHR	1/1	65,5x48	44	25,3/4x19	17,3/8

Con:

Coperchio rotante a scomparsa

Portavivande 1/1 Gastronorm

2 bruciatori per pasta - combustibile

Predisposto per piastra elettrica

With:

Rolltop

1/1 gastronorm food pan

2 solid fuel burners.

Electric heating element

(available as optional)



Fornelletto per scaldavivande

Chafing-dish burner

Porte-brûleur pour chafing dish

Brennstoffhalter für Chafing Dish

Contenedor de combustible para chafing dish

V77 05 52 FDC



Piastra elettrica per scaldavivande

Heating element for chafing-dishes

Plaque électrique réchauffeur chafing dish

Elektro - Heizelement für Chafing Dish

Plancha eléctrica para calienta platos

	V	W	Hz
V77 05 52 PCR	220	500	50

V77 05 52 PCR1 230 250

Con regolatore With power regulator

Con fornelli

Whit burners

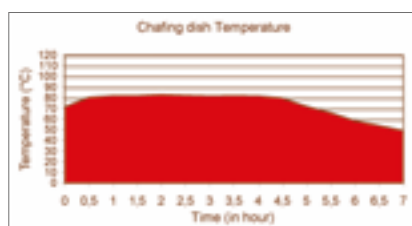

Temperatura ambiente External temperature	20,3°
Temperatura acqua Water temperature	94°
Quantità acqua inserita Quantity of water added	6 Lt.
Fonte di calore Heat source	2 fornelli a fiamma 2 burners

Con piastra elettrica

Whit heating element

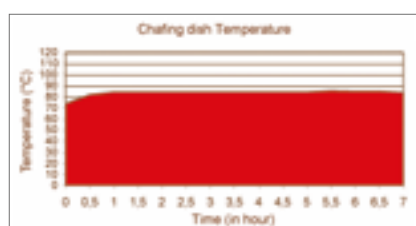

Temperatura ambiente External temperature	20,3°
Temperatura acqua Water temperature	94°
Quantità acqua inserita Quantity of water added	6 Lt.
Fonte di calore Heat source	piastra elettrica heating element

Scaldavivande tondo con coperchio rotante

Round rolltop chafing dish
Chafing dish rond avec couvercle pivotant
Chafing Dish - rund mit Rolltophaube
Calientaplatos redondo con campana

	∅ Cm	H Cm	∅ In	H In
V77 05 52 CHT	50	46	15,3/4	18,1/8

Con:

Coperchio rotante a scomparsa
Portavivande ∅ 40 Cm
1 bruciatore per pasta - combustibile
Predisposto per piastra elettrica

With:

Rolltop
Food pan ∅ 40 Cm
Solid fuel burners.
Electric heating element
(available as optional)



Fornelletto per scaldavivande

Chafing-dish burner
Porte-bruleur pour chafing dish
Brennstoffhalter für Chafing Dish
Contenedor de combustible para chafing dish

V77 05 52 FDC



Piastra elettrica per scaldavivande

Heating element for chafing-dishes
Plaque électrique réchauffeur chafing dish
Elektro - Heizelement für Chafing Dish
Plancha eléctrica para calienta platos

	V	W	Hz
V77 05 52 PCT	220	500	50

V77 05 52 PCT1 230 250
Con regolatore With power regulator

Con fornelli Whit burners

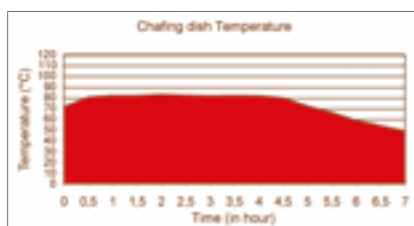

Temperatura ambiente External temperature	20,3°
Temperatura acqua Water temperature	94°
Quantità acqua inserita Quantity of water added	6 Lt.
Fonte di calore Heat source	2 fornelli a fiamma 2 burners

Con piastra elettrica Whit heating element

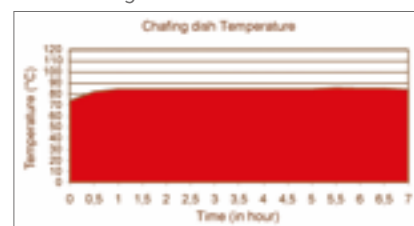

Temperatura ambiente External temperature	20,3°
Temperatura acqua Water temperature	94°
Quantità acqua inserita Quantity of water added	6 Lt.
Fonte di calore Heat source	piastra elettrica heating element

Portavivande in porcellana

Food pan, porcelain
Bac en porcelaine
Porzellanbehälter
Cubeta de porcelana

	GN	Cm	In
V01 21 52 G11B	1/1	53x32,5x6,5	20,7/8x12,3/4x2,1/2
V01 21 52 G23B	2/3	35,3x32,5x6,5	13,3/4x12,3/4x2,1/2
V01 21 52 G12B	1/2	26,5x32,5x6,5	10,3/8x12,3/4x2,1/2
V01 21 52 G13B	1/3	17,6x32,5x6,5	6,7/8x12,3/4x2,1/2

**Portavivande tondo in porcellana**

Round food pan, porcelain
Bac rond en porcelaine
Porzellanbehälter, rund
Cubeta redonda de porcelana

	ø Cm	ø In
V01 21 52 T40	40	15,3/4

**Inserto scaldavivande tondo in porcellana**

Food pan half round chafing dish, porcelain with divider
Bac double en porcelaine pour chafing dish rond
Porzellaninsatz, 2tlg für Chafing Dish rund
Cubeta avec separation de porcelana para chafing dish redondo

	ø Cm	ø In
V01 21 71 T12 (1 pz.)	40 Cm	15,3/4

**Set zuppiere per scaldavivande tondo**

Soup tureen set for Cm. 40 round chafing dish
Set de soupières pour chafing dish rond
Suppenschüssel für Chafing Dish rund
Set de soperas para chafing dish redondo

	ø Cm	ø In	Lt	Oz
V77 05 52 ACT	40	15,3/4	4,2	142

**Set minstre per scaldavivande rettangolare**

Soup tureen set for rectangular chafing dish
Set de soupières pour chafing dish rectangulaire
Suppenschüssel für Chafing Dish rechteckig
Set de soperas para chafing dish rectangular

	GN	Lt	Oz
V77 05 52 ACR	1/1	4,2	142



Porta cereali girevole a 3 comparti*

Triple rotating cereal holder
 Distributeur céréales pivotant à 3 compartiments
 Büffet-Ständer - drehbar mit 3 Glasschalen
 Dipensador de cereales giratorio 3 sectores

	ø Cm	ø In
V77 05 52 CER 3	42	16,1/2



*Sono escluse le ciotole in vetro
 *Without glass bowls

Porta cereali girevole a 6 comparti*

6-dish rotating cereal holder
 Distributeur céréales pivotant à 6 compartiments
 Büffet-Ständer - drehbar mit 6 Glasschalen
 Dipensador de cereales giratorio 6 sectores

	ø Cm	ø In
V77 05 52 CER	42	16,1/2 in



Ciotola in vetro

Glass bowl
 Bol en verre
 Glasschale
 Bol de vidrio

	ø Cm	ø In	Lt	Oz
310 08 42 527	23	9	1,3	60



Coperchio in metacrilato

Acrylic lid
 Couvercle acrylique
 Deckel aus Metakryl
 Tapa acrílica

	ø Cm	ø In
310 12 15 795	23	9

Con pomolo in metacrilato - With acrylic knob

	ø Cm	ø In
310 12 15 790	23	9

Con pomolo in acciaio inox - With St. Steel knob



BUFFET IMPERIAL

Distributore cereali girevole a 3 comparti con base in acciaio

Triple rotating cereal dispenser with stainless steel base

Distributeur céréales pivotant à 3 compartiments avec base en acier inoxydable

3-Müslidispenser-drehbar mit Stahlboden

Dispensador de cereales giratorio 3 sectores con base de acero inoxidable

	ø Cm	H Cm	ø In	H In	Lt	Oz
V77 05 52 CD6	42	60	16,1/2	23,5/8	3 (x3)	101 (x3)

Con:

Contentore removibile

Pomolo in metallo

Spazzola interna

Girandola dosatrice

With:

Removable container

Metal knob

Inner brush

Doser handle



Contentore removibile

Consente di riempirlo e pulirlo facilmente

Removable container

It allows to be filled in and cleaned easily



Spazzola interna

non rompe i cereali

Inner brush

that does not break cereals

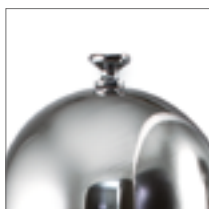

Dettaglio pomolo in metallo

Detail of metal knob



Girandola dosatrice

Doser handle



Distributore cereali singolo con base in acciaio

Single cereal dispenser with stainless steel base

Distributeur céréales individuel avec base en acier inoxydable

Müslidispenser mit Stahlboden

Dispensador de cereales individual con base de acero inoxidable

	Cm	H Cm	In	H In	Lt	Oz
V77 05 52 CD4	31x21	60	12,1/4x8,1/4	23,5/8	3	101



Distributore cereali a 2 comparti con base in acciaio

Double cereal dispenser with stainless steel base

Distributeur céréales à 2 compartiments avec base en acier inoxydable

2-Müslidispenser mit Stahlboden

Dispensador de cereales 2 sectores con base de acero inoxidable

	Cm	H Cm	In	H In	Lt	Oz
V77 05 52 CD5	37,5x24,5	60	14,3/4x9,5/8	23,5/8	3 (x2)	101 (x2)



Portayogurt

Yogurt tray
Plateau porte-yogourt
Joghurtplatte
Bandeja yogur

	∅ Cm	∅ In	H Cm	H In
V77 05 52 T46	46	18,1/8	5	2



Portaburro-crostacei

Butter tray
Plateau porte-beurre/crustacés
Butter/Krustazeenplatte
Bandeja mantequilla

	∅ Cm	∅ In	H Cm	H In
V77 05 09 T32	32	12,5/8	5	2
V77 05 09 T46	46	18,1/8	5	2



Tagliere per pane con base acciaio

Bread cutting board
Planche à découper à pain
Tabla de cortar pan
Brotschneidebrett

	Cm	H Cm	In	H In
V01 05 54 004	53x32,5	3,5	20,7/8x12,3/4	1,1/8



Cestino portabrioche tondo con cloche basculante

Round croissant basket with rolltop cover

Corbeille ronde à viennoiseries avec cloche basculante

Büffetkorb - rund mit Rolltophaube

Cesta de buffet redonda con campana roll top

Rattan

	ø Cm	ø In	HCm	H In
V77 04 52 T44	44	17,3/8	35	13,3/4



Coperchio a bascula tondo trasparente

Transparent round rolltop cover

Cloche basculante ronde transparente

Rolltophaube - rund

Campana redonda roll top transparente

	ø Cm	ø In
V77 12 15 T46	41	16,1/8

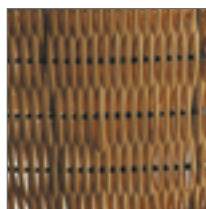

Cestino rattan

Rattan basket

Corbeille rottin

Rattankorb

Cesta ratán

	ø Cm	ø In
V77 04 24 T44	41	17,3/8

Interno rotondo in adatto al contatto con gli alimenti

Inside base for rattan round croissant basket. Suitable for food contact

Revêtements intérieurs, apte au contacte alimentaire

Innenverkleidung Lebensmittel geeignet

Forro interior, apto para alimentos

Polistirene

	ø Cm	ø In	H Cm	H In
Z77 46 52 T44	41	14,1/8	11	4,3/8

Cestino portabrioches rettangolare con cloche basculante

Rattan rectangular croissant basket with rolltop cover
 Corbeille rectangulaire à viennoiseries avec cloche basculante
 Büffetkorb - rechteckig mit Rolltophaube
 Cesta de buffet rectangular con campana roll top

Rattan

	Cm	In	H Cm	H In
V77 04 52 R50	50x29,5	19,3/4x11,5/8	29,5	11,5/8



Coperchio a bascula rettangolare trasparente

Transparent rectangular rolltop cover
 Cloche basculante rectangulaire transparente
 Rolltophaube - rechteckig
 Campana roll top rectangular transparente

	Cm	In
V77 12 15 G36	37x21	14,1/2x8,1/4
V77 12 15 G11	47x27	18,1/2x10,5/8

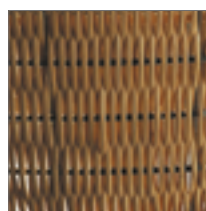

Cestino rattan

Rattan basket
 Corbeille rottin
 Rattankorb
 Cesta ratân

	Cm	In
V77 04 24 R39	38,5x23	15,1/8x9
V77 04 24 R50	50x29,5	19,3/4x11,5/8

Interno rettangolare adatto al contatto con gli alimenti

Inside base for rattan rectangular croissant basket. Suitable for food contact
 Revêtements intérieurs, apte au contacte alimentaire
 Innenverkleidung Lebensmittel geeignet
 Forro interior para cestas de buffet, apto para alimentos

Polistirene

	∅ Cm	∅ In	H Cm	H In
Z77 46 52 R50	50x27	15x7,5/8	11	4,3/8

Coperchio in metacrilato

Acrylic lid
Couvercle acrylique
Deckel Acryl
Tapa acrílica

	∅ Cm	∅ In
310 12 15 795	23	9

Con pomolo in metacrilato - With acrylic knob

310 12 15 790	23	9
---------------	----	---

Con pomolo in acciaio inox - With St. Steel knob

**Ciotola in vetro**

Glass bowl
Bol en verre
Glasschale
Bol de vidrio

	∅ Cm	∅ In	HCm	H In
310 08 42 527	23	9	10,5	4,1/8

**Rinfrescamacedonia/yogurt con contenitore ghiaccio esterno con coperchio**

Fruit-salad/yogurt cooler with outer ice container and lid
Rafraîchisseur salade de fruits/yogourt avec récipient à glace externe et couvercle
Joghurt/Obstsalatbehälter mit Eisbehälter außen und mit Deckel
Portaensalada de frutas/yogur refrigerado con recipiente para hielo externo y tapa

Metacrilato

	∅ Int. Cm	∅ Int. In	∅ est. Cm	∅ est. In
V77 05 43 YOG 2	23	9	26	10,1/4

**Rinfrescamacedonia/yogurt con contenitore ghiaccio esterno in acciaio con coperchio**

Fruit-salad/yogurt cooler with outer ice container and lid
Rafraîchisseur salade de fruits/yogourt avec récipient à glace externe avec couvercle
Joghurt/Obstsalatbehälter mit Edelstahl - Eisbehälter außen mit Deckel
Portaensalada de frutas/yogur refrigerado con recipiente para hielo externo con tapa

Acciaio

	∅ Int. Cm	∅ Int. In	∅ est. Cm	∅ est. In
V77 05 43 YOG	23	9	28	11



Distributore caffè con rubinetto in metallo

Coffee urn
Distributeur café
Kaffeedispenser
Dispensador de café

	∅ Cm	∅ In	H Cm	H In	Lt	Oz
V77 05 52 DCA	21	8,4	54	21,1/4	7	237
V77 05 52 DCA 1	21	8,4	62	24,3/8	10	350

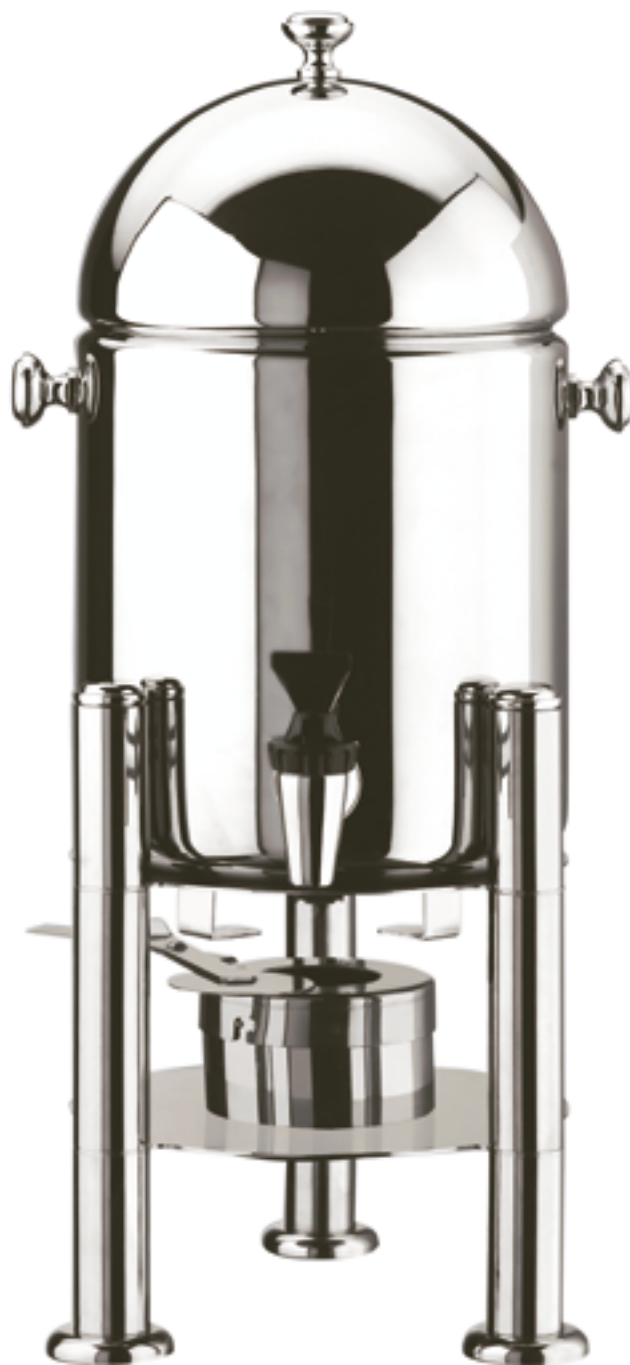

Rubinetto in metallo

Metal tap
Robinet en métal
Metallhahn
Grifo de metal

Z77 18 52 OTT



Piastra elettrica per distributore caffè

Heating element for coffee urns
Plaque électrique pour distributeur de café
Elektro-Heizelement für Kaffeedispenser
Plancha eléctrica para dispensadores de café

	∅ Cm	∅ In
V77 05 52 PDC	14	5,1/2



Fornelletto per scaldavivande/distributore caffè

Burner for chafing dishes-coffee urns
Porte bruleur pour chafing dish et distributeur café
Brennstoffhalter für Chafing Dish und Kaffeedispenser
Contenedor de combustible para chafing dish - dispensadores de café

V77 05 52 FDC

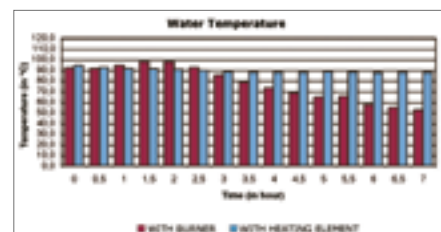

Temperatura ambiente
External temperature 20,0°

Temperatura acqua
Water temperature 92,5°/98,8°

Quantità acqua inserita
Quantity of water added 8 Lt

Distributore succhi

Juice dispenser
Distributeur jus
Saftdispenser
Dispensador de zumo

**Con rubinetto in metallo**

With metal tap
Avec robinet en métal
Mit Metallhahn
Con grifo de metal

	Cm	H Cm	Lt
V77 05 52 DSM	25x35	66	8
	In	H In	Oz
	9,7/8x13,3/4	26	270

Rubinetto in metallo

Metal tap
Robinet en métal
Metal- Holzständer
Grifo de metal

Z77 18 52 OTT**Con rubinetto in plastica**

With plastic tap
Avec robinet en plastique
Mit Kunststoffhahn
Con grifo de plástico

	Cm	H Cm	Lt
V77 05 52 DSU	25x35	66	8
	In	H In	Oz
	9,7/8x13,3/4	26	270

Rubinetto in plastica nero

Plastic tap
Robinet en plastique
Plastikhahn
Grifo de plástico

Z77 18 52 POL**Contentitore trasparente**

Transparent container
Récipient transparent
Durchsichtbare Behälter
Contenedor transparente

	Lt	Oz
Z77 63 52 000	8	270

**Eutettici tondi**

Round ice packs
Blocs réfrigérants
Kühlakkus
Acumuladores de frío rectangulares

V77 12 95 T01

Distributore succhi con base legno

Juice dispenser with wooden base
 Distributeur jus avec base en bois
 Saftdispenser mit Holzboden
 Dispensador de zumo con base de madera



Con rubinetto in metallo e base legno

With metal tap and wooden base
 Avec robinet en métal et base en bois
 Hahn aus Metall- Holzständer
 Con grifo de metal y base de madera

	Cm	H Cm	Lt
V77 05 52 DSM	25x35	66	8
	In	H In	Oz
	9,7/8x13,3/4	26	270

Rubinetto in metallo

Metal tap
 Robinet en métal
 Metall- Holzständer
 Grifo de metal

Z77 18 52 OTT



Con rubinetto in plastica e base legno

With plastic tap and wooden base
 Avec robinet en plastique et base en bois
 Hahn aus Plastik - Holzständer
 Con grifo de plástico y base de madera

	Cm	H Cm	Lt
V77 05 52 DSUW	25x35	66	8
	In	H In	Oz
	9,7/8x13,3/4	26	270

Rubinetto in plastica nero

Plastic tap
 Robinet en plastique
 Plastikhahn
 Grifo de plástico

Z77 18 52 POL



Tubo refrigerante in acciaio per distributore succhi

St. Steel cooling pipe for juice dispenser
 Tube réfrigéré pour distributeur jus
 Kühlrohr für Saftverteiler
 Tubo refrigerante para dispensador de zumo

	ø Cm	ø In
Z77 42 52 DSU	6	2,3/8

Con tubo refrigerante

With cooling pipe

Temperatura ambiente External temperature	20,0°
Temperatura acqua Water temperature	7,6°
Quantità acqua inserita Quantity of water added	7 Lt

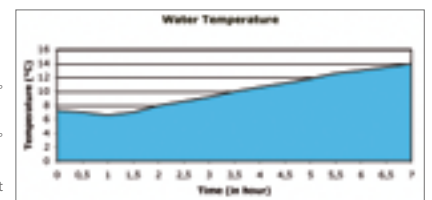

Senza tubo refrigerante

Without cooling pipe

Temperatura ambiente External temperature	20,0°
Temperatura acqua Water temperature	7,6°
Quantità acqua inserita Quantity of water added	7 Lt

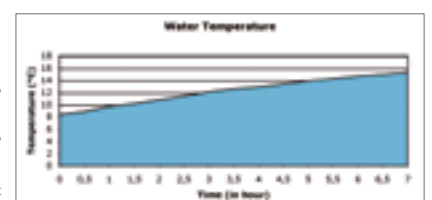

Supporto refrigerato per caraffe succhi con vassoio portabicchieri*

Thermal stand for juice pitchers with glasses tray*

Support réfrigéré pour carafes jus avec plateau porte-verres

Saftkaraffenständer gekühlt mit Gläserständer

Soporte refrigerante para jarras zumo con bandeja para vasos

	ø Cm	ø In	H Cm	H In
V77 05 52 SUC			67	26,3/8
Base	41,5	16,3/8		
Alzata - Holder	38,5	15,1/8		
Sede caraffa - Pitcher seat	16,4	6,1/2		

Supporto refrigerato per caraffe succhi*

Thermal stand for juice* pitchers

Support réfrigéré pour carafes jus

Saftkaraffenständer gekühlt

Soporte refrigerante para jarras zumo

	ø Cm	ø In	H Cm	H In
V77 05 52 SUS			36	14,1/8
Base	41,5	16,3/8		
Sede caraffa - Pitcher seat	16,4	6,1/2		



Disco coprietettici per supporto refrigerante per caraffe

Plate for thermal stand for juice pitchers (to cover ice packs)

Plaque couvre-blocs réfrigérants pour support réfrigéré pour carafes

Deckel für Kühlelemente zum Karaffenbehälter

Placa cubre acumuladores de frío para soporte refrigerante para jarras

	ø Cm	ø In
PRV 1A SU CAD S0	41	16,1/8

*Sono escluse le caraffe in vetro
*Without pitchers

Caraffa succhi

Juice pitcher
Carafe jus
Saftkanne
Jarra zumo

	Lt	Oz
V76 08 52 005	1,5	51

Con coperchio in metallo - with metal lid

V76 08 52 009	1,5	51
---------------	-----	----

Senza coperchio - without lid



Coperchio in acciaio 18/10

Stainless steel lid
Couvercle en acier 18/10
Deckel aus Edelstahl
Tapa de acero inoxidable

Z76 01 52 005



Caraffa termica

Thermal beverage serve
Carafe thermos avec anse
Thermische Karaffe
Jarra térmica

	Cl	Oz
V01 05 08 T06	75	26
V01 05 08 T10	100	35
V01 05 08 T15	150	51
V01 05 08 T20	200	68



75 Cl - 26 Oz

Temperatura ambiente 19,6°
External temperature

Temperatura acqua 94°
Water temperature

Quantità acqua inserita 60 cl.
Quantity of water added

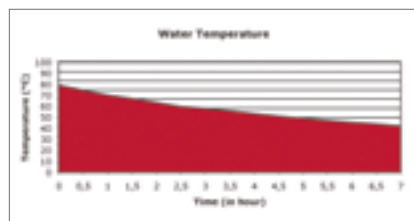

100 Cl - 35 Oz

Temperatura ambiente 19,6°
External temperature

Temperatura acqua 94°
Water temperature

Quantità acqua inserita 90 cl.
Quantity of water added

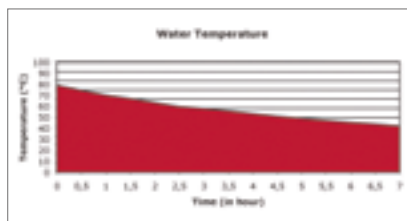

150/200 Cl - 53/70 Oz

Temperatura ambiente 20,9°
External temperature

Temperatura acqua 95°
Water temperature

Quantità acqua inserita 150 cl.
Quantity of water added

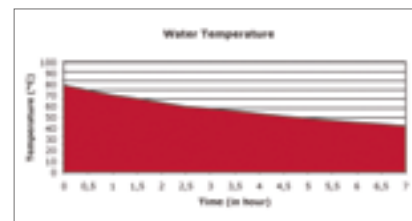

Alzata torta

Cake stand
 Presentoir à gâteau
 Tortenplatte
 Soporte tarta

Inox 18/10 - St. Steel

	ø Cm	ø In	H Cm	H In
V01 05 42 022	22	8,5/8	9,5	3,3/4
V01 05 42 032	32	12,5/8	12,5	12,5
V01 05 42 042	42	16,1/2	16,5	6,1/2

**Alzata torta 3 piani**

3-tier cake stand
 Présentoir à gâteau 3 étages
 Kuchenständer 3-stufig
 Soporte tarta con 3 pisos

Inox 18/10 - St. Steel

	ø Cm	ø In	H Cm	H In
V01 05 42 301	22/32/42	8,5/8-12,5/8-16,1/2	43,5	17,1/8

**Alzata frutta 3 piani**

3-tier fruit stand
 Serviteur à fruits 3 étages
 Obstständer 3-stufig
 Frutero con 3 pisos

Inox 18/10 - St. Steel

	ø Cm	ø In	H Cm	H In
V77 05 42 326	22/29/36,5	8,5/4-11,3/8-14,3/8	44	17,3/8



Piatto torta con coperchio a bascula

Cake tray with roll top cover
 Plateau à gâteaux avec cloche basculante
 Kuchenplatte mit Rolltophaube
 Plato para tartas con campana roll top

Inox 18/10 - St. Steel

	∅ Cm	∅ In
V76 05 42 003	38	15

Coperchio a bascula tondo trasparente

Transparent round rolltop cover
 Cloche basculante ronde transparente
 Rolltophaube - rund
 Campana redonda transparente

SAN

	∅ Cm	∅ In
V76 12 15 T01	34	13,3/8



Alzata torta con coperchio a bascula

Cake stand with roll top cover
 Présentoir à gâteaux avec cloche basculante
 Kuchenplatte mit Schaukeldeckel
 Soporte para tartas con campana roll top

Inox 18/10 - St. Steel

	∅ Cm	H Cm	∅ In	H In
V76 05 42 002	38	12,5	15	4,7/8



Vassoio torta con cupola in policarbonato Basic

Basic cake tray with acrylic dome cover
 Plateau à gâteau avec cloche acrylique Basic
 Kuckenplatte mit Akrylglocke Basic
 Plato para tartas con campana acrílica Basic

Inox 18/10 - St. Steel

	∅ Cm	∅ In
V01 05 42 T32	31	12,1/4







TAVOLA • TABLE

Caffettiera Imperial

Imperial coffeepot
Cafetière Imperial
Kaffekanne Imperial
Cafetera Imperial

Inox 18/10 - St. Steel

	Cl	Oz
V01 05 01 035	35	12
V01 05 01 060	60	20
V01 05 01 100	100	35
V01 05 01 150	150	51
V01 05 01 200	200	68

**Teiera Imperial**

Imperial teapot
Théière Imperial
Teekanne Imperial
Tetera Imperial

Inox 18/10 - St. Steel

	Cl	Oz
V01 05 02 035	35	12
V01 05 02 060	60	20
V01 05 02 100	100	35
V01 05 02 130	130	44

**Lattiera Imperial**

Imperial milkpot
Pot à lait Imperial
Milchkanne Imperial
Lechera Imperial

Inox 18/10 - St. Steel

	Cl	Oz
V01 05 03 035	35	12
V01 05 03 060	60	20
V01 05 03 100	100	35

**Cremiera Imperial**

Imperial creamer
Crémier Imperial
Sahnekännchen Imperial
Jarrita de leche Imperial

Inox 18/10 - St. Steel

	Cl	Oz
V01 05 03 015	15	5



Caraffa termica Imperial

Imperial thermal beverage server

Carafe thermos Imperial

Thermoskanne Imperial

Jarra térmica Imperial

Inox 18/10 - St. Steel

	Cl	Oz
V01 05 08 T06	70	24
V01 05 08 T10	100	35
V01 05 08 T15	150	51
V01 05 08 T20	200	68

**Zuccheriera con maniglie Imperial**

Imperial sugar pot with lid and handles

Sucrier avec couvercle et poignées Imperial

Zuckerdose mit Griffen und Deckel Imperial

Azucarero con tapa y asas Imperial

Inox 18/10 - St. Steel

	Gr	Oz
V01 05 04 280	280	10

**Brocca acqua Imperial**

Imperial water pitcher

Carafe à eau Imperial

Wasserkrug Imperial

Jarra agua Imperial

Inox 18/10 - St. Steel

	Cl	Oz
V01 05 08 150	150	51
V01 05 08 200	200	68

**Zuccheriera Imperial**

Imperial sugar pot

Sucrier Imperial

Zuckerdose Imperial

Azucarero Imperial

Inox 18/10 - St. Steel

	Gr	Oz
V01 05 04 200	200	7



Porta cannuce

Straw holder
Porte-pailles
Trinkhalmbehälter
Portapajitas

Inox 18/10 - St. Steel

	∅ Cm	∅ In	H Cm	H In
V01 05 71 011	9	3,1/2	11	4,3/8

**Porta cucchiaini**

Tea spoon holder
Porte-cuillères à café
Kaffeelöffelbecher
Portacucharas café

Inox 18/10 - St. Steel

	∅ Cm	∅ In	H Cm	H In
V01 05 71 008	9	3,1/2	8	3,1/8

**Portabustine zucchero/the**

Rectangular sugar tray
Sucrier rectangulaire
Zucker-Behälter
Azucarero rectangular

Inox 18/10 - St. Steel

	Cm	In	H Cm	H In
V78 05 04 PBU	10x6,5	4	3,5	1,3/8

**Passa tè (colino tè) con coppetta**

Tea strainer
Passoire à the
Teesieb
Colador de te

Inox 18/10 - St. Steel

	Cm	H Cm	In	H In
V01 05 91 001	9,5x5	3	3,3/4x2	1,1/8



Portauovo

Egg cup
Coquetier
Eierbecher
Huevera

Inox 18/10 - St. Steel

	∅ Cm	∅ In
V01 05 71 001	8,6	3,3/8

**Burriera piccola con coperchio**

Small butter dish with cover
Petit beurrier avec cloche
Klein Butterschale mit Deckel
Mantequera pequeña con tapa

Inox 18/10 - St. Steel

	∅ Cm	∅ In
V01 05 09 107	7	2,3/4
Z01 20 09 107	7	2,3/4 porcellana/porcelain

**Burriera con coperchio**

Butter dish with cover
Beurrier avec cloche
Butterschale mit Deckel
Mantequera con tapa

Inox 18/10 - St. Steel

	∅ Cm	∅ In
V01 05 09 115	15	6
Z01 20 09 115	15	6 porcellana/porcelain

**Porta salatini 3 scomparti**

3-tier snack/relish dish
Porte-biscuits salés à 3 compartiments
Salzgebäckschale, 3-tlg
Entremesera 3 sectores

Inox 18/10 - St. Steel

	∅ Cm	∅ In
V01 05 41 003	10,5	4,1/8



Portamarmellata per 4 confezioni

4-jar jam holder

Porte-confiture pour 4 pots

Konfitürenschaale, 4 tlg

Dispensador de mermelada para 4 botes

Inox 18/10 - St. Steel

	Cm	In
V76 05 09 001	18x45	7,1/8x1,3/4

**Porta marmellata 3 scomparti**

3-tier jam dish

Porte-confiture à 3 compartiments

Konfitürenschaale, 3 tlg

Dispensador de mermelada 3 sectores

Inox 18/10 - St. Steel

	∅ Cm	H Cm	∅ In	H In
V01 05 09 003	6	13	2,3/8	5,1/8

**Porta marmellata 6 scomparti**

6-tier jam dish

Porte-confiture à 6 compartiments

Konfitürenschaale, 6 tlg

Dispensador de mermelada 6 sectores

Inox 18/10 - St. Steel

	∅ Cm	H Cm	∅ In	H In
V01 05 09 006	6	17,5	2,3/8	6,7



Alzata pasticceria

Petit four stand
Support à pâtisserie
Petits-Fours-Ständer
Presentación pastelería

Inox 18/10 - St. Steel

	ø Cm	H Cm	ø In	H In
V01 05 41 012	12	11	4,3/4	4,3/8
V01 05 41 016	16	11,5	6,1/4	4,1/2
V01 05 41 022	22	12	8,5/8	4,3/4

**Alzata pasticceria 2 piani**

2-tier petit four stand
Support à pâtisserie à 2 étages
Petits-fours ständer 2-stufig
Presentación pastelería 2 pisos

Inox 18/10 - St. Steel

	ø Cm	H Cm	ø In	H In
V01 05 41 201	12/16	21,5	4,3/4-6,1/4	8,1/2
V01 05 41 202	16/22	22,5	6,1/4-8,5/8	8,7/8

**Alzata pasticceria 3 piani**

3-tier petit four stand
Support à pâtisserie à 3 étages
Kuchenständer 3-stufig
Presentación pastelería 3 pisos

Inox 18/10 - St. Steel

	ø Cm	H Cm	ø In	H In
V01 05 41 301	12/16/22	31	4,3/4-6,1/4-8,5/8	12,1/4



Servitore té/pasticceria

Afternoon tea stand
Stand thé/pâtisserie
Tee/Kuchenstander
Soporte para platos

Inox 18/10 - St. Steel

	ø Cm	H Cm	ø In	H In
V76 05 42 005	30	42	11,3/4	16,1/2
V76 05 42 004	25	40	9,7/8	15,3/4

**Alzata torta**

Cake stand
Surtout
Kuchenteller
Bandeja para tarta

Inox 18/10 - St. Steel

	ø Cm	H Cm	ø In	H In
CI 22600	32	3,5	12,5/8	1,3/8

**Alzata torta**

Cake stand
Presentoir à gâteau
Tortenplatte
Presentación tarta

Inox 18/10 - St. Steel

	ø Cm	H Cm	ø In	H In
V01 05 42 022	22	9,5	8,5/8	3,3/4
V01 05 42 032	32	12,5	12,5/8	12,5
V01 05 42 042	42	16,5	16,1/2	6,1/2

**Alzata torta 3 piani**

3-tier cake stand
Présentoir à gâteau 3 étages
Kuchenständer 3-stufig
Presentación tarta 3 pisos

Inox 18/10 - St. Steel

	ø Cm	H Cm	ø In	H In
V01 05 42 301	22/32/42	43,5	8,5/8-12,5/8-16,1/2	17,1/8



Alzata frutta

Fruit stand
 Serviteur à fruits
 Obststände
 Frutero

Inox 18/10 - St. Steel

	ø Cm	H Cm	ø In	H In
V77 05 42 126	22	12,5	8,5/8	5
V77 05 42 132	29	12,5	11,3/8	5
V77 05 42 138	36,5	12,5	14,3/8	5

**Alzata frutta 2 piani**

2-tier fruit stand
 Serviteur fruits à 2 étages
 Obststände 2-stufig
 Frutero 2 pisos

Inox 18/10 - St. Steel

	ø Cm	H Cm	ø In	H In
V77 05 42 226	22/29	22,5	8,5/8-11,3	8-8,7/8

**Alzata frutta 3 piani**

3- tier fruit stand
 Serviteur à fruits 3 étages
 Obststände 3-stufig
 Frutero 3 pisos

Inox 18/10 - St. Steel

	ø Cm	H Cm	ø In	H In
V77 05 42 326	22/29/36,5/44	8,5/4	11,3/8/14,3/8	17,3/8



Sottopiatto bordo inglese

Show plate with English decoration

Plat à présentation avec décoration anglaise

Platzteller mit englischer Dekoration

Plato de presentación con borde inglés

Inox 18/10 - St. Steel

	∅ Cm	∅ In
V01 05 25 132	31,5	12,3/8

**Sottopiatto liscio**

Show plate, plain

Plat à présentation simple

Platzteller

Plato de presentación liso

Inox 18/10 - St. Steel

	∅ Cm	∅ In
V01 05 25 032	31	12,1/4

**Sottobottiglia**

Bottle coaster

Sous bouteille

Flaschenuntersatz

Posabotella

Inox 18/10 - St. Steel

	∅ Cm	∅ In
V01 05 21 014	14	5,1/2

**Sottobicchiere**

Glass coaster

Sous verre

Untersatz

Posavasos

Inox 18/10 - St. Steel

	∅ Cm	∅ In
V01 05 21 011	11	4,3/8



Cestino pane rettangolare Square

Bread basket Square, rectangular
 Corbeille à pain rectangulaire Square
 Brotkorb Square, rechteckig
 Cesta pan rectangular Square

Inox 18/10 - St. Steel

	Cm	In
V76 05 24 002	20x12	7,7/8x4,3/4

**Cestino pane rettangolare Square**

Bread basket Square, rectangular
 Corbeille à pain rectangulaire Square
 Brotkorb Square, rechteckig
 Cesta pan rectangular Square

Inox 18/10 - St. Steel

	Cm	In
V76 05 24 003	27x12	10,5/8x4,3/4

**Panno per cestino pane c/velcro ecru**

Cloth for bread basket, beige
 Tissu pour corbeille à pain écru
 Sandfarbenes Tuch für Brotkorb
 Paño para cesta pan beige

	Cm	In
AS9 1CP	27	10,5/8

Cestino in filo agrumi

Citrus-fruit basket

Corbeille à agrumes

ObstKorb Edelstahl Draht für Zitrusfrüchte

Cesta cítricos

Inox 18/10 - St. Steel

	∅ Cm	H Cm	∅ In	H In
906 05 001	21 Cm	20	8,1/4	7,7/8

**Cestino in filo frutta**

Fruit basket

Corbeille à fruits

ObstKorb Edelstahl Draht

Cesta frutas

Inox 18/10 - St. Steel

	∅ Cm	H Cm	∅ In	H In
906 05 004	25	9	9,7/8	3,1/2

**Cestino in filo frutta**

Fruit basket

Corbeille à fruits

ObstKorb Edelstahl Draht

Cesta frutas

Inox 18/10 - St. Steel

	∅ Cm	H Cm	∅ In	H In
906 05 003	20	8	7,7/8	3,1/8

**Cestino in filo frutta**

Fruits basket

Corbeille à fruits

ObstKorb Edelstahl Draht

Cesta frutas

Inox 18/10 - St. Steel

	∅ Cm	H Cm	∅ In	H In
906 05 002	18	7	7,1/8	2,3/4



Cestino in filo grissini

Bread stick basket
Corbeille à gressins
Grissini-Korb Edelstahl Draht
Cesta palillos

Inox 18/10 - St. Steel

	ø Cm	H Cm	ø In	H In
906 05 005	10	14	3,7/8	5,1/2

**Cestino ovale in filo**

Oval s/s basket
Corbeille ovale
Ovorkorb Edelstahl Draht
Cesta oval

Inox 18/10 - St. Steel

	Cm	H Cm	In	H In
906 05 016	28x21	9	11x8,1/4	3,1/2

**Cestino ovale in filo**

Oval s/s basket
Corbeille ovale
Ovorkorb Edelstahl Draht
Cesta oval

Inox 18/10 - St. Steel

	Cm	H Cm	In	H In
906 05 015	25x18	8	9,7/8x7	3,1/8

**Cestino ovale in filo**

Oval s/s basket
Corbeille ovale
Ovorkorb Edelstahl Draht
Cesta oval

Inox 18/10 - St. Steel

	Cm	H Cm	In	H In
906 05 014	20x15	7	7,7/8x6	2,3/4



Coppetta liscia multiuso

Small cup, plain multipurpose
 Petite coupe simple multi-usage
 Universalschale
 Copita lisa multiuso

Inox 18/10 - St. Steel

	Cm	In
V05 05 43 L13	13	5,1/8

**Cestino pane liscio Majorca**

Mallorca bread basket, plain
 Corbeille à pain Mallorca
 Brotkorb Mallorca
 Cesta pan Mallorca lisa

Inox 18/10 - St. Steel

	Cm	In
V05 05 24 L18	18,5x18,5	7,1/4 x7,1/4
V05 05 24 L23	23x23	9x9

**Cestino pane forato Majorca**

Mallorca bread basket, slotted
 Corbeille à pain Mallorca, perforée
 Lochbrotkorb Mallorca
 Cesta pan con agujeros Mallorca

Inox 18/10 - St. Steel

	Cm	In
V05 05 24 F18	18,5x18,5	7,1/4 x7,1/4
V05 05 24 F23	23x23	9x9

**Cestino pane ovale**

Bread basket, oval
 Corbeille à pain ovale
 Brotkorb, oval
 Cesta pan oval

Inox 18/10 - St. Steel

	Cm	In
V01 05 24 028	28x15	11x6



**Anello adattatore**

Adjusting ring
Bague de réglage
Einsatzring
Anillo adaptador

Inox 18/10 - St. Steel

	Cm	In
V01 05 43 540	13 Cm	5,1/8

**Coppetta interna**

Supreme inside cup
Coupe intérieure
Schale
Copita interior

Inox 18/10 - St. Steel

	Cm	In
V01 05 43 562	10,5	4,1/8

**Piattino portaburro**

Butter dish
Plat à beurre
Butterschale
Platito mantequilla

Inox 18/10 - St. Steel

	ø Cm	ø In
V01 05 43 648	13	5,1/8

**Griglia portaburro**

Butter grid
Grille porte-beurre
Buttergitter
Parrilla mantequilla

Inox 18/10 - St. Steel

	ø Cm	ø In
V01 05 43 539	13	5,1/8

**Coppa esterna base**

Supreme outside base cup
Coupe base extérieure Supreme
Schale auf Fuß
Copa exterior base Supreme

Inox 18/10 - St. Steel

	ø Cm	ø In
V01 05 43 130	13	5,1/8

**Coppa Supreme completa**

Supreme cup
Coupe Supreme
Hummer-/Cocktailschale
Copa Supreme, completa

Inox 18/10 - St. Steel

	ø Cm	H Cm	ø In	H In
V01 05 43 C13	13	8,5	5,1/8	3,3/8
3 Pezzi - 3 Pieces				

V01 05 43 C135	13	8,5 Cm	5,1/8	3,3/8
5 Pezzi - 5 Pieces				

Set breakfast

Breakfast set
Service petit déjeuner
Tablet mit Frühstück zubehören
Set desayuno

Inox 18/10 - St. Steel

	Cm	In
V76 05 23 002	24	9,1/2

**Set lunch**

Lunch set
Service lunch
Öl und Essig set Tablett
Set almuerzo

Inox 18/10 - St. Steel

	Cm	In
V76 05 23 003	24	9,1/2

**Set sauces appetizer**

Set sauces appetizer
Service sauces-appetizer
Söße und Apertiven set Soßen
Set salsas-aperitivos

Inox 18/10 - St. Steel

	Cm	In
V76 05 23 004	24	9,1/2



Vetro salino Square c/tappo

Glass cruet salt spreader Square w/cap
Verre pour salière Square avec couvercle
Salzstreuer mit Schraubverschluß
Vidrio salero Square c/tapa

Acciaio inossidabile - St. Steel

V76 05 12 001

**Ampolla olio/aceto Square c/tappo**

Glass cruet oil/vinegar set Square w/cap
Burette huile/vinaigre Square avec bouchon
Essig/Ölglas flaschen mit Schraubverschluß
Alcuza aceite/vinagre Square c/tapa

Acciaio inossidabile - St. Steel

V76 05 11 001

**Portatovaglioli Square**

Napkin holder
Porte-serviettes
Serviettenhalter
Servilletero

Inox 18/10 - St. Steel

	Cm	H Cm	In	H In
V76 05 71 001	11x4	8	4,3/8x1,2/3	3,1/8

**Portabustine zucchero/the**

Packed sugar/tea holder
Conteneur sachets de sucre/té
Zucker-Teebeutelbehälter
Porta sobres de azúcar/té

Inox 18/10 - St. Steel

	Cm	H Cm	In	H In
V78 05 04 PBU	10x6,5	3,5	3,7/8x2,1/2	1,3/8

**Ciotola porcellana quadra**

Porcelain square bowl
Bol carré en porcelaine
Porzellanschale, viereckig
Bol cuadrado de porcelana

Porcelain

	Cm	In
V86 21 42 CQ7	7x7	2,3/4x2,3/4

**Formaggiiera**

Cheese bowl
Ravier a parmesan
Käsedose
Quesera

Acciaio inossidabile - St. Steel

V76 05 13 002



Coppa macedonia Imperial

Fruit salad cup
Coupe à dessert
Obstsalatschale
Copa macedonia

Inox 18/10 - St. Steel

	∅ Cm	∅ In	H Cm	H In
V01 05 43 125	12,5	5	5,5	2

**Coppa gelato**

Ice cream cup
Coupe à glace
Eisschale
Copa helado

Inox 18/10 - St. Steel

	∅ Cm	∅ In
V01 05 43 105	10,5	4,1/8

**Coppa gelato Imperial**

Imperial ice cream cup
Coupe à glace Imperial
Eisschale Imperial
Copa helado Imperial

Inox 18/10 - St. Steel

	∅ Cm	∅ In	H Cm	H In
V01 05 43 010	9,5	3,3/4	10	4

**Piattino sottocoppa**

Cup saucer
Plat sous coupe
Untersatz
Platito posacopa

Inox 18/10 - St. Steel

	∅ Cm	∅ In
V01 05 21 013	13	5,1/8

**Portafiori**

Flower vase
Vase à fleurs
Blumenvase
Florero

Inox 18/10 - St. Steel

	H Cm	H In
V01 05 19 015	16,5	6,1/2

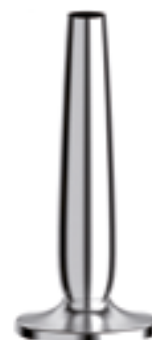

Vassoio rendiresto bordo inglese

Small change tray with English edge
 Plateau porte-monnaie avec rebord anglais
 Geldplatte mit englischem Rand
 Bandeja portamoneda con borde inglés

Inox 18/10 - St. Steel

	Cm	In
V01 05 23 R25	24x9,5	9,1/2x3,3/4

**Vassoio multiuso**

Multipurpose tray
 Plateau universelle
 Universale Platte
 Bandeja universal

Inox 18/10 - St. Steel

	Cm	In
CI 3005	24x9	9,1/2x3,1/2
CI 3006	29x13,5	11,1/2x5,3/8

**Salsiera con piattino**

Sauce boat with underliner
 Saucière avec soucoupe
 Soßenschüssel mit Tellerchen
 Salsera con platito

Inox 18/10 - St. Steel

	Cl	Mm
V61 05 12 030	30	0,8

**Salsiera**

Sauce boat
 Saucière
 Soßenschüssel
 Salsera

Inox 18/10 - St. Steel

	Cl	Mm
CI 25401	10	0,8
CI 25402	20	0,8
CI 25403	30	0,8

**Cloche**

Dome cover
 Cloche
 Speiseglocke
 Campana

Inox 18/10 - St. Steel

	Ø Cm	Ø In
V01 05 53 024	24	9,1/2
V01 05 53 026	26	10,1/4
V01 05 53 028	28	11
V01 05 53 030	30	11,3/4



Portatovaglioli

Napkin holder
Porte-serviette
Serviettenhalter
Servilletero

Inox 18/10 - St. Steel

	Cm	H Cm	In	H In
V01 05 71 105	10,5	9	4,1/8	3,1/2

**Portatovaglioli**

Napkin holder
Porte-serviettes
Serviettenhalter
Servilletero

Inox 18/10 - St. Steel

	Cm	H Cm	In	H In
V76 05 71 001	11x4	8	4,3/8x1,2/3	3,1/8

**Portatovaglioli quadrato**

Napkin holder, square
Porte-serviette carré
Viereckiger Serviettenhalter
Servilletero cuadrado

Inox 18/10 - St. Steel

	Cm	H Cm	In	H In
V01 05 71 190	19x19	7	7,1/2x7,1/2	2,3/4

**Portakleenex**

Kleenex holder
Porte-kleenex
Taschentücherhalter
Porta kleenex

Inox 18/10 - St. Steel

	Cm	H Cm	In	H In
V01 05 71 002	22x12	5,5	8,5/8x4,3/4	2,1/8

**Lavadita**

Finger bowl
Rince-doigts
Fingerschale
Lavadedos

Inox 18/10 - St. Steel

	∅ Cm	∅ In
V01 05 43 012	12	4,3/4



Portatovaglioli da banco verticale

Vertical napkin holder

Porte-serviettes vertical

Vertikaler Thekenserviettenhalter

Servilletero cuadrado vertical

Inox 18/10 - St. Steel

	Cm	H Cm	In	H In
906 05 008	8,5x11	16	3,3/8x4,3/8	6,1/4

**Paletta raccogli briciole**

Crumb sweeper

Pelle ramasse-miettes

Krümelsammler

Pala recogemigas

Inox 18/10 - St. Steel

	Cm	In
903 05 91 939	12	4,3/4

**Legatovaglioli tondo**

Round napkin ring

Rond de serviette

Serviettenhalter

Servilletero redondo

Inox 18/10 - St. Steel

	∅ Cm	∅ In
V01 05 81 001	4 Cm	1,2/3

**Legatovaglioli ovale**

Oval napkin ring

Rond de serviettes ovale

Serviettenhalter, oval

Servilletero oval

Inox 18/10 - St. Steel

	Cm	In
V01 05 81 000	5x4	2x1,2/3





Segnatavolo a colonna (portanumero)

Table number stand, column-shaped

Support numéro de table à colonne

Tischnummerständer

Número sobremesa a columna

Inox 18/10 - St. Steel

	H Cm	H In
V01 05 19 019	19	7,1/2
V01 05 19 046	45	17,3/4



Cavalletto portaetichetta per buffet

Buffet easel for tags

Chevalet porte-nom pour buffet

Aufsteller Produktinfo

Soporte caballete para etiqueta para buffet

Inox 18/10 - St. Steel

	H Cm	H In
V01 05 19 001	14,5	5,3/4

Tavoletta nera per cavalletto

Black tag for easel

Plaque pour chevalet noir

Schild für Produktinfo

Etiqueta negra para soporte caballete

Plexiglass

	H Cm	H In
V01 12 19 001	10x7,5	4x3



Portatoast in filo

Toast holder, steel wire

Porte-toasts en fil

Toastständer

Portatostadas en hilo

Inox 18/10 - St. Steel

	Cm	H Cm	In	H In
V01 05 71 195	19,5	15	7,5/8	6

Formaggiara Imperial

Imperial grated-cheese holder
 Ravier à parmesan Imperial
 Käsedose Imperial
 Quesera Imperial

Inox 18/10 - St. Steel

V01 05 13 001



Oliera 4 pezzi Imperial

Imperial oil & vinegar cruet set, 4-piece
 Ménagère Imperial, 4 pièces
 Menage, 4-tlg Imperial
 Servicio de mesa Imperial, 4 piezas

Inox 18/10 - St. Steel

V01 05 11 005



Oliera 2 pezzi Imperial

Imperial oil & vinegar cruet set, 2-piece
 Ménagère Imperial, 2 pièces
 Menage, 2-tlg Imperial
 Servicio de mesa Imperial, 2 piezas

Inox 18/10 - St. Steel

V01 05 11 002



Tris sale, pepe e stecchi Imperial

Imperial salt and pepper shakers and toothpick holder
 Salière, poivrière et porte cure-dents Imperial
 Salz/Pfefferstreuer und Zahnstocherträger Imperial, 3-tlg
 Salero, pimentero y palillero Imperial

Inox 18/10 - St. Steel

V01 05 12 003



Spargi sale/pepe singolo Imperial

Imperial salt/pepper shaker
 Salière/poivrière individuelle Imperial
 Salz/Pfefferstreuer Imperial
 Salero/pimentero individual Imperial

Inox 18/10 - St. Steel

V01 05 12 001



Formaggiera 2000

2000 Cheese bowl
Fromagère 2000
Käsedose 2000
Quesera 2000

Acciaio inossidabile - St. Steel

V61 05 13 001

**Oliera 5 pezzi Menage**

Menage oil & vinegar cruet set, 5-piece
Ménagère Menage, 5 pièces
Menage, 5-tlg
Servicio de mesa Menage, 5 piezas

Acciaio inossidabile - St. Steel

V12 06 11 005

**Tris sale, pepe e stecchi inox**

Salt and pepper shakers and toothpick holder, plain
Salière, poivrière et porte cure-dents simples
Salz/Pfefferstreuer mit Zahnstochträger, Edelstahl
Tris salero, pimentero y palillero inox

Acciaio inossidabile - St. Steel

V12 06 12 003

**Oliera 5 pezzi Victory**

Victory oil & vinegar cruet set, 5-piece
Ménagère Victory, 5 pièces
Essig/Ölgestell 5-tlg Victory
Servicio de mesa Victory, 5 piezas

Inox 18/10 - St. Steel

V52 05 11 005



Oliera 2 pezzi Victory

Victory oil & vinegar cruet set, 2-piece
Ménagère Victory, 2 pièces
Essig/Ölgestell 2-tlg Victory
Servicio de mesa Victory, 2 piezas

Inox 18/10 - St. Steel

V52 05 11 002



Tris sale, pepe e stecchi Victory

Victory salt and pepper shakers and toothpick holder
Salière, poivrière et porte cure-dents Victory
Salz/Pfeffersteuer mit Zahnstocherträger, 3-tlg Victory
Salero, pimentero y palillero Victory

Inox 18/10 - St. Steel

V52 05 12 003



Formaggiera Victory

Victory grated-cheese holder
Ravier à parmesan Victory
Käsedose Victory
Quesera Victory

Inox 18/10 - St. Steel

V52 05 13 001



Portabottiglie olio/aceto

Oil and vinegar bottle rack
Porte bouteilles huile-vinaigre
Essig/Ölflaschenträger
Portabotellas aceite y vinagre

Acciaio inossidabile - St. Steel

	Cl	Oz	Cm	In
AVARI 060	25	9	12x5,5x25	3,1/2
AVARI 061	50	17,5	14x7x81	6,7/8



Portabottiglie olio/aceto con spargisale/pepe

Oil and vinegar bottle rack with salt and pepper shakers
Porte bouteilles huile-vinaigre, salière, poivrière
Essig/Ölflaschenträger, salz/pfeffersteuer
Portabotellas aceite y vinagre, salero, pimentero

Acciaio inossidabile - St. Steel

	Cl	Oz	Cm	In
AVARI 060 A	25	9	12x5,5x25	3,1/2
AVARI 061 A	50	17,5	14x7x81	6,7/8



Oliera Pasha

Pasha oil & vinegar cruet set

Ménagère Pasha

Menage Pasha

Servicio de mesa Pasha

- V02 12 11 004 02
- V02 12 11 004 07
- V02 12 11 004 06
- V02 12 11 004 10
- V02 12 11 004 12
- V02 12 11 004 13
- V02 12 11 004 29
- V02 12 11 004 36
- V02 12 11 004 95
- V02 12 11 004 34

**Oliera Jolly**

Jolly oil & vinegar cruet set

Ménagère Jolly

Menage Jolly

Servicio de mesa Jolly

- V10 12 11 004 41
- V10 12 11 004 34
- V10 12 11 004 29
- V10 12 11 004 43
- V10 12 11 004 35

**Formaggiera Pasha con vaso vetro**

Pasha grated-cheese holder

Ravier à parmesan Pasha

Käsedose Pasha

Quesera Pasha

PP+PS

- V02 12 13 001 02
- V02 12 13 001 07
- V02 12 13 001 06
- V02 12 13 001 10
- V02 12 13 001 12
- V02 12 13 001 13
- V02 12 13 001 29
- V02 12 13 001 36
- V02 12 13 001 95
- V02 12 13 001 34

**Formaggiera Jolly**

Jolly grated-cheese holder

Ravier à parmesan Jolly

Käsedose Jolly

Quesera Jolly

PP+PS

- V10 12 13 001 41
- V10 12 13 001 34
- V10 12 13 001 29
- V10 12 13 001 43
- V10 12 13 001 35



Ricambi Imperial/Victory

Imperial/Victory spare parts
Pièces de rechange Imperial/Victory
Imperial/Victory Ersatzteilen
Repuestos Imperial/Victory

AR33 TAPPO OLIERA CON SALVAGOCCIA / DROP STOP CAP OIL CRUETS

AR31 CAPSULA SALINO / CAP SALT SHAKER

AR32 CAPSULA STECCHI / CAP TOOTHPICK HOLDERS



AR31



AR32

Ricambi Cronos

Cronos spare parts
Pièces de rechange Cronos
Cronos Ersatzteilen
Repuestos Cronos

AR8 TAPPO OLIERA CON SALVAGOCCIA / DROP STOP CAP OIL CRUETS

AR12 CAPSULA SALE E PEPE / CAP FOR SALT AND PEPPER

AR25 CAPSULA STECCHI / CAP FOR TOOTHPICK



AR8



AR12



AR25

Ampolla vetro oliera Cronos/Imperial/Victory

Glass cruet for Cronos/Imperial/Victory cruet sets
Bouchon anti-goutte pour huilier Imperial/Victory
Glas Ersatzteil für Öl-und Essigset
Tapón antigoteo para aceitera Imperial/Victory

	∅ Cm	H Cm	∅ In	H In
AR3	5	13,5	2	5,3/8



Vetro formaggiiera Cronos/Imperial/Pasha/Jolly

Glass bowl for Cronos/Imperial/Pasha/Jolly
Bol en verre pour ravier à parmesan Cronos/Imperial/Pasha/Jolly
Glas Ersatzteil für Käsedose Cronos/Imperial/Pasha/Jolly
Bol de vidrio para Cronos/Imperial/Pasha/Jolly

	∅ Cm	H Cm	∅ In	H In
AR14	9	4,9	3,1/2	2



Vetro salino Mondial/Cronos/Imperial/Pasha/Jolly/Menage/Dribbly

Glass bowl for Mondial/Cronos/Imperial/Pasha/Jolly/Menage/Dribbly salt/pepper shakers
Bouteille verre pour salière Mondial/Cronos/Imperial/Pasha/Jolly/Menage/Dribbly
Glas Ersatzteil für Salz und Pfefferstreuer
Botellita de vidrio para salino Mondial/Cronos/Imperial/Pasha/Jolly/Menage/Dribbly shakers

	∅ Cm	H Cm	∅ In	H In
AR4	3-5	8	1,3/8	3,1/8



Vassoio tondo bar

Round bar tray
Plateau rond bar
Austellplatte, rund
Bandeja redonda bar

Inox 18/10 - St. Steel

	ø Cm	ø In
V01 05 23 T32	32	12,5/8
V01 05 23 T38	38	15
V01 05 23 T46	46	18,1/8
V01 05 23 T54	54	21,1/4

**Vassoio tondo bar con maniglie**

Round bar tray with handles
Plateau rond bar avec poignées
Austellplatte mit Griffen, rund
Bandeja redonda bar con asas

Inox 18/10 - St. Steel

	ø Cm	ø In
V01 05 23 T32M	32	12,5/8
V01 05 23 T38M	38	15
V01 05 23 T46M	46	18,1/8
V01 05 23 T54M	54	21,1/4

**Vassoio tondo con bordo Basic**

Round tray Basic
Plateau rond Basic
Austellplatte, rund Basic
Bandeja redonda Basic

Inox 18/10 - St. Steel

	ø Cm est.	ø Cm Int.	ø In ext.	ø In Int.
V01 05 23 TB31	31	27	12,1/4	10,5/8
V01 05 23 TB36	36	30	14,1/8	11,3/4
V01 05 23 TB41	41	35	16,1/8	13,3/4

**Vassoio birra**

Beer tray
Plateau à bière
Bierplatte
Bandeja para cerveza

Inox 18/10 - St. Steel

	ø Cm	ø In
CI 5411	30	11,3/4
CI 5412	40	15,3/4



Vassoio rettangolare gastronorm

Gastronorm tray, rectangular
 Plateau rectangulaire Gastronorm
 Austellplatte, rechteckig, Gastronorm
 Bandeja rectangular Gastronorm

Inox 18/10 - St. Steel

	Cm	In
V01 05 23 G12	26,5x32,5	10,3/8x12,3/4
V01 05 23 G11	53x32,5	20,7/8x12,3/4
V01 05 23 G21	65x53	25,5/8x20,7/8

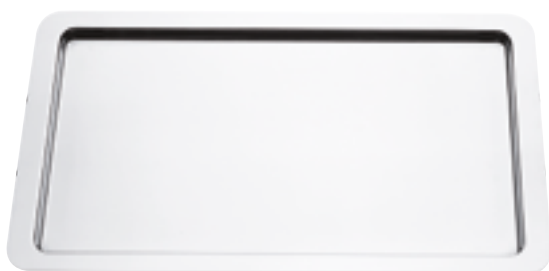
**Vassoio rettangolare gastronorm con maniglie**

Gastronorm tray with handles, rectangular
 Plateau rectangulaire Gastronorm avec poignées
 Austellplatte mit Griffen, rechteckig, Gastronorm
 Bandeja rectangular Gastronorm con asas

Inox 18/10 - St. Steel

	Cm	In
V01 05 23 G12M	32,5x26,5	12,3/4x10,3/8
V01 05 23 G11M	53x32,5	20,7/8x12,3/4
V01 05 23 G21M	65x53	25,5/8x20,7/8

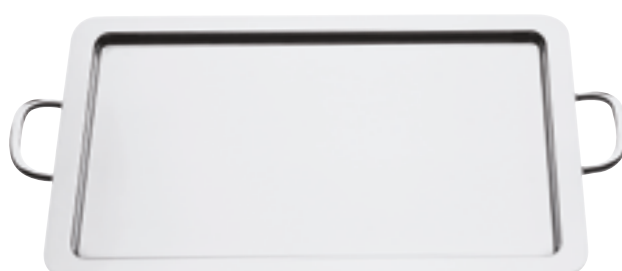
**Vassoio rettangolare Basic**

Gastronorm tray, rectangular
 Plateau rectangulaire Gastronorm
 Austellplatte, rechteckig Gastronorm
 Bandeja rectangular Gastronorm

Inox 18/10 - St. Steel

	Cm	In
V01 05 23 GB12	26,5x32,5	10,3/8x12,3/4
V01 05 23 GB11	53x32,5	20,7/8x12,3/4
V01 05 23 GB21	65x53	25,5/8x20,7/8

**Vassoio gratin ovale**

Gratin tray
 Plat gratin ovale
 Ovale gratin Platte
 Plato gratin oval

Inox 18/10 - St. Steel

	Cm	In
CI 24501	28x17	11x6,3/4



Vassoio rettangolare bar con bordo

Bar tray with edge, rectangular
 Plateau rectangulaire bar avec rebord
 Austellplatte, rechteckig
 Bandeja rectangular bar con borde

Inox 18/10 - St. Steel

	Cm	In	Sp. mm
V01 05 23 R30	30x24	11,3/4x9,1/2	0,8
V01 05 23 R35	35x29	13,3/4x11,1/2	0,8
V01 05 23 R40	40x31	15,3/4x12,1/4	1,0
V01 05 23 R45	45x34	17,3/4x13,3/8	1,0
V01 05 23 R52	52x40	20,1/2x15,3/4	1,0
V01 05 23 R62	62x48	24,3/8x19	1,0

**Vassoio rettangolare bar senza bordo**

Bar tray without edge, rectangular
 Plateau rectangulaire bar sans rebord
 Austellplatte rechteckig
 Bandeja rectangular bar sin borde

Inox 18/10 - St. Steel

	Cm	In	Sp. mm
V03 05 23 R27	27x21	10,5/8x8,1/4	0,8
V03 05 23 R30	30x24	11,3/4x9,1/2	0,8
V03 05 23 R35	35x28	13,3/4x11	0,8
V03 05 23 R40	40x32	15,3/4x12,5/8	1,0
V03 05 23 R45	45x35	17,3/4x13,3/4	1,0
V03 05 23 R50	50x38	19,3/4x15	1,0

**Vassoio rettangolare bar Easy con bordo**

Easy bar tray with edge, rectangular
 Plateau rectangulaire bar Easy avec rebord
 Rechteckig Ausstellplatte "Easy" mit Rand
 Bandeja rectangular bar Easy con borde

Inox 18/10 - St. Steel

	Cm	In	Sp. mm
V65 05 23 R32	32x26	12,5/8x10,1/4	0,6
V65 05 23 R36	36x29	14,1/8x11,1/2	0,6
V65 05 23 R40	40x33	15,3/4x13	0,6
V65 05 23 R45	45x34	17,3/4x13,3/8	0,6
V65 05 23 R52	52x40	20,1/2x15,3/4	0,6

**Vassoio rettangolare bar senza bordo**

Bar tray without edge, rectangular
 Plateau rectangulaire bar sans rebord
 Austellplatte rechteckig
 Bandeja rectangular bar sin borde

Acciaio Inossidabile - St. Steel

	Cm	In	Sp. mm
V03 06 23 R27	27x21	10,5/8x8,1/4	0,8
V03 06 23 R31	30x24	11,3/4x9,1/2	0,8
V03 06 23 R36	35x28	13,3/4x11	0,8
V03 06 23 R40	40x32	15,3/4x12,5/8	1,0
V03 06 23 R45	45x35	17,3/4x13,3/4	1,0
V03 06 23 R50	50x38	19,3/4x15	1,0



Piatto portata ovale con bordo Easy

Easy plate with edge, oval
Assiette ovale Easy avec rebord
Oval Tablett "Easy" mit Rand
Fuente oval Easy con borde

Inox 18/10 - St. Steel

	Cm	In
V65 05 23 020	20X11	7,7/8x4,3/8
V65 05 23 025	25x17	9,7/8x6,3/4
V65 05 23 030	30x21	11,3/4x8,1/4
V65 05 23 035	35x24	13,3/4x9,1/2
V65 05 23 040	40x27	15,3/4x10,5/8
V65 05 23 045	45x30	17,3/4x11,3/4
V65 05 23 050	50x33	19,3/4x13
V65 05 23 059	59X40	23,1/4x15,3/4

**Piatto ovale senza bordo**

Plate without edge, oval
Assiette ovale sans rebord
Bratenplatte, oval
Fuente oval sin borde

Inox 18/10 - St. Steel

	Cm	In
V03 05 22 025	25x17	9,7/8x6,3/4
V03 05 22 030	30x21	11,3/4x8,1/4
V03 05 22 035	35x24	13,3/4x9,1/2
V03 05 22 040	40x27	15,3/4x10,5/8
V03 05 22 045	45x31	17,3/4x12,1/4
V03 05 22 050	50x35	19,3/4x13,3/4

**Piatto portata tondo con bordo**

Plate with edge, round
Assiette ronde avec rebord
Bratenplatte, rund mit Rand
Fuente redonda con borde

Inox 18/10 - St. Steel

	∅ Cm est.	∅ Cm Int.	∅ In ext.	∅ In Int.
V01 05 22 T29	29	20	11,1/2	7,7/8
V01 05 22 T34	34	24	13,3/8	9,1/2
V01 05 22 T38	38	26	15	10,1/4

**Piatto portata pesce**

Fish plate
Assiette à poisson
Fischplatte
Fuente para pescado

Acciaio inossidabile - St. Steel

	Cm	In
V01 05 22 P60	60x24,5	23,5/8x9,5/8
V01 05 22 P70	70x28,5	27,1/2x11,1/4



Vassoio sovrapponibile gastronomo rettangolare

Stackable gastronorm rectangular tray

Plateau empilable gastronorme rectangulaire avec poignées

Gastronorm Tablett - rund und stapelbar

Bandeja rectangular gastronorm apilable

Inox 18/10 - St. Steel

	Cm	In
V01 05 23 G11S	53x32,5	20,7/8x12,3/4
V01 05 23 G21S	65x53	25,5/8x20,7/8

**Vassoio sovrapponibile gastronomo tondo**

Stackable gastronorm round tray

Plateau empilable rond avec poignées

Tablett-rund und stapelbar

Bandeja redonda gastronorm apilable

Inox 18/10 - St. Steel

	∅ Cm	In
V01 05 23 T46S	46	18,1/8
V01 05 23 T54S	54	21,1/4



Coperchio legumiera/zuppiera

Cover for vegetable dish/soup tureen

Couvercle pour soupière/légumier

Deckel für Suppen-Gemüseschüssel

Tapa legumbrera/sopera

Inox 18/10 - St. Steel

	ø Cm	ø In
V01 05 15 C14	14	5,1/2
V01 05 15 C18	18	7,1/8
V01 05 15 C22	22	8,5/8
V01 05 15 C24	24	9,1/2
V01 05 15 C26	26	10,1/4
V01 05 15 C28	28	11
V01 05 15 C30	30	11,3/4

**Zuppiera**

Soup tureen

Soupière

Suppenschüssel

Sopera

Inox 18/10 - St. Steel

	ø Cm	ø In	Lt	Oz
V01 05 15 Z14	14	5,1/2	0,75	25
V01 05 15 Z18	18	7,1/8	1,5	50
V01 05 15 Z22	22	8,5/8	2,5	85
V01 05 15 Z24	24	9,1/2	3,5	118
V01 05 15 Z26	26	10,1/4	4,25	144
V01 05 15 Z28	28	11	5,25	178
V01 05 15 Z30	30	11,3/4	6,5	220

**Legumiera**

Vegetable dish

Légumier

Gemüseschüssel

Legumbrera

Inox 18/10 - St. Steel

	ø Cm	ø In	Lt	Oz
V01 05 15 L14	14	5,1/2	0,8	27
V01 05 15 L18	18	7,1/8	1,4	47
V01 05 15 L22	22	8,5/8	1,9	64
V01 05 15 L24	24	9,1/2	2,8	94,6
V01 05 15 L26	26	10,1/4	3,8	128,5
V01 05 15 L28	28	11	4,8	162





Celsius è il nuovo piatto che mantiene costante la temperatura delle pietanze senza continuare il processo di cottura, per conservare al meglio il gusto di ogni ricetta.

Design moderno ed essenziale, che si abbina a ogni mise en place e innovativa funzionalità grazie alla presa ergonomica della base in legno, che protegge dalle scottature.

La piastra in alluminio viene **riscaldato in forno**, regolando temperatura e tempo a seconda della pietanza, per poi essere posizionata sotto il piatto in acciaio che, a contatto con gli alimenti, **mantiene costante la temperatura** del cibo durante il pasto.

Celsius è un prodotto **igienico e di facile pulizia**: il piatto in acciaio (unica componente a contatto con gli alimenti) è comodamente lavabile in lavastoviglie, a differenza delle pietre ollari che assorbono i grassi, non sono lavabili e alterano lo stato di cottura delle pietanze.

Celsius è disponibile in quattro versioni per rispondere a ogni esigenza, dal singolo posto tavola ai momenti di convivialità, e in due forme adatte a diverse tipologie di pietanze come ad esempio le carni e la pizza.

Celsius. Per non servire più cibi freddi!

Celsius is the new plate that keeps food temperature constant without continuing the cooking process, to best preserve the taste of every recipe.

Modern and essential design, matching with every place setting, and innovative functionality, thanks to the ergonomic grip, and the wood base, that protects from burning.

The aluminum plate is **warmed into the oven**, adjusting temperature and time based on the food; then it is placed under the steel plate that, in contact with food, **keeps its temperature constant** during the meal.

Celsius is a healthy product and **easy to clean**: the steel plate (the only component in contact with food) is dishwasher safe while, for instance, soapstone, that absorbs fat, is not washable and alters food cooking.

Celsius comes in four versions to meet every need, from the individual place setting to the large gatherings, and in two different shapes, suitable for different foods, like meat and pizza.

Celsius. You will not serve cold food anymore!

IDEALE PER SERVIRE
PERFECT TO SERVE



CARNE
MEAT



PESCE
FISH



VERDURE
VEGETABLES



PIZZA E NON SOLO
PIZZA & MORE

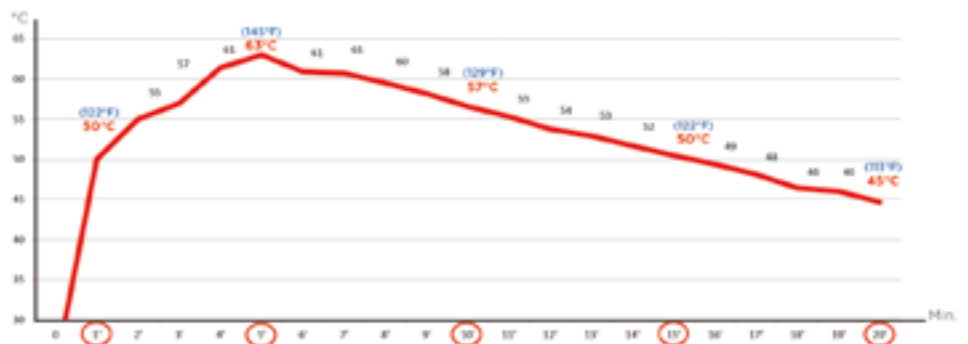

Vassoio grill rettangolare

Rectangular grill tray
 Plateau grill rectangulaire
 Grilltablett rechteckig
 Bandeja grill rectangular

	Cm	In
V89 05 22 R01	29x20	11,1/2x7,7/8
V89 05 22 R02	34x24	13,3/8x9,1/2

**Piatto**

Plate
 Plat
 Edelstahl Tablett rechteckig
 Plato

Acciaio Inox 18/10 - Stainless Steel 18/10

	Cm	In
V89 05 22 R01	29x20	9,7/8x7,1/4
V89 05 22 R02	34x24	11,5/8x8,1/2

**Piastra alluminio**

Aluminum plate
 Plaque aluminium
 Aluminiumplatte
 Placa aluminium

Acciaio aisi 304 - Steel aisi 304

	Cm	In
Z89 15 22 R01	19x12	7,1/2x4,3/4
Z89 15 22 R02	24x15,5	9,1/2x6,1/8

**Base rettangolare**

Rectangular base
 Base rectangulaire
 Holzgestell rechteckig
 Base rectangular

Legno di betulla - Birch wood

	Cm	In
Z89 19 22 R01	29x20	11,1/2x7,7/8
Z89 19 22 R02	34x24	13,3/8x9,1/2

Vassoio grill ovale

Oval grill tray
Plateau grill oval
Grilltablett oval
Bandeja grill oval

	Cm	In
V89 05 22 T01	28x32	1x12,5/8
V89 05 22 T02	38x34	15x13,3/8



Piatto

Plate
Plat
Edelstahl Tablett oval
Plato

Acciaio Inox 18/10 - Stainless Steel 18/10

	ø Mm	ø In
Z89 05 22 T01	255	10
Z89 05 22 T02	315	12,3/8



Piastra alluminio

Aluminum plate
Plaque aluminium
Aluminiumplatte
Placa aluminium

Acciaio aisi 304 - Steel aisi 304

	ø Mm	ø In
Z89 15 22 T01	200	7,7/8
Z89 15 22 T02	240	9,1/2



Base ovale

Oval base
Base ovale
Holzgestell oval
Base oval

Legno di betulla - Birch wood

	Mm	In
Z89 19 22 T01	28x32	1x12,5/8
Z89 19 22 T02	38x34	15x13,3/8





WINE ● BAR

Glacette doppio corpo

Double wall bottle cooler
 Rafrâchisseur à bouteille/vin double paroi
 Weinkühler, doppelwandig
 Enfriador de botella doble pared

Inox 18/10 - St. Steel

	ø Cm	ø In	H Cm	H In
V78 05 24 014	13	5,1/8	21	8,1/4

**Secchio champagne per 2/3 bottiglie**

Champagne cooler for 2/3 bottles
 Seau à champagne pour 2/3 bouteilles
 2/3 Flaschen Champagnerkühler
 Cubo champán para 2/3 botellas

Inox 18/10 - St. Steel

	ø Cm	ø In	H Cm	H In
V78 05 20 022	22	8,5/8	21	8,1/4

**Supporto secchio spumante linea Wine&Bar**

Wine&Bar champagne cooler stand
 Support pour seau à champagne Wine&Bar
 Wine&Bar Champagnerkühler Ständer
 Soporte para cubo champán Wine&Bar

Inox 18/10 - St. Steel

	ø Cm	ø In	H Cm	H In
V78 05 20 675	23	9	58	22,7/8



Shaker

Cocktail shaker
Shaker
Cocktail Shaker
Coctelera

Inox 18/10 - St. Steel

	Lt	Oz
V78 05 81 SHA	0,7	17

**Bicchieri Boston**

Boston mixing container
Verre en métal pour Boston
Boston Metallbecher
Vaso en metal para Boston

Inox 18/10 | vetro - St. Steel | glass

	Lt	ø Cm	H Cm	H In
V78 05 81 SHA 2B 0,7	9	17	6,3/4	acciaio
V78 08 81 SHA 2B 0,7	9	17	6,3/4	vetro

**Secchiello ghiaccio doppio corpo**

Double wall ice bucket
Seau à glace double paroi
Eiswürfelbehälter, doppelwandig
Cubo hielo doble pared

Inox 18/10 - St. Steel

	ø Cm	ø In	H Cm	H In
V78 05 20 014	13	5,1/8	18	7,1/8

**Scoladecanter**

Decanter wine stand
Egouttoir de carafe
Karaffentrockner
Soporte para decantador

Acciaio inossidabile - St. Steel

	H Cm	H In
V01 05 24 020	30	11,3/4

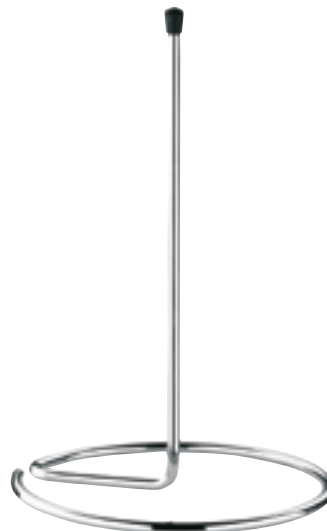

Secchio ghiaccio Modern

Modern ice bucket
 Seau à glace Modern
 Eismwürfelbehälter Modern
 Cubo hielo Modern

Inox

		∅ Cm	∅ In	H Cm	H In
V78 05 20 00 11 401	est	15	6	17	6,3/4
	int	13	5,1/8		

**Secchio champagne Modern**

Modern Champagne cooler
 Seau à champagne Modern
 Modern Champagnekühler
 Cubo champán Modern

Inox

		∅ Cm	∅ In	H Cm	H In
V78 05 20 002		24	9,1/2	22,5	8,7/8

**Glacette**

Modern glacette
 Glacette Modern
 Weinkühler Modern
 Enfriador de botella

inox

		∅ Cm	∅ In	H Cm	H In
V78 05 24 01 01 401	est	12	4.3/4	19,5	7,5/8
	int	10	4		

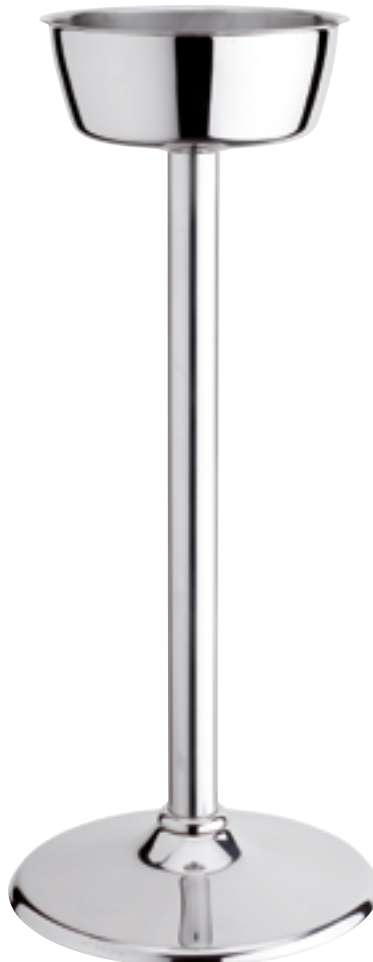
**Supporto secchio Basic**

Basic champagne cooler stand
 Support pour seau à champagne Basic
 Basic Champagnekühler Ständer
 Soporte para cubo champán Basic

Inox 18/10 - St. Steel

	H Cm	∅ Cm	H In	∅ In
V01 05 20 674	61	21	24	8,1/4

Secchio ghiaccio Imperial

Imperial ice bucket
 Seau à glace Imperial
 Imperial Eiswürfelbehälter
 Cubo hielo Imperial

Inox 18/10 - St. Steel

	∅ Cm	∅ In	H Cm	H In
V01 05 20 013	13,5	5,3/8	13	5,1/8



Secchio champagne Imperial

Imperial champagne cooler
 Seau à champagne Imperial
 Imperial Champagnekühler
 Cubo champán Imperial

Inox 18/10 - St. Steel

	∅ Cm	∅ In	H Cm	H In
V01 05 20 020	21	8,1/4	20	7,7/8



Supporto secchio Imperial

Imperial champagne cooler stand
 Support pour seau à champagne Imperial
 Imperial Champagnekühler Ständer
 Soporte para cubo champán Imperial

Inox 18/10 - St. Steel

	∅ Cm	∅ In	H Cm	H In
V01 05 20 675	21	8,1/4	61	24



Secchio champagne Basic

Basic champagne bucket

Seau à champagne Basic

Sektkübler Basic

Cubo champán Basic

Acciaio inossidabile - St. Steel

	ø Cm	ø In	H Cm	H In
906 05 013	21,5	8,1/2	21	8,1/4

**Secchio ghiaccio Basic**

Basic ice bucket

Seau à glace Basic

Eiskühler Basic

Cubo hielo Basic

Acciaio inossidabile - St. Steel

	ø Cm	ø In	H Cm	H In
906 05 012	13	5,1/8	13	5,1/8

**Cocktail shaker Basic**

Basic cocktail shaker

Cocktail shaker Basic

Cocktail Shaker Basic

Coctelera Basic

Acciaio inossidabile - St. Steel

	Lt	Oz
V78 05 81 SHA1	0,5	17

**Misurino Basic**

Basic jigger

Mésure Basic

Meßbecher Basic

Medida bar Basic

Acciaio inossidabile - St. Steel

	Ml	Oz
V78 05 81 DOS1	15-30	1/2-1

**Filtro cocktail Basic**

Basic cocktail strainer

Passoire à cocktail Basic

Barsieb Basic

Colador de cóctel Basic

Acciaio inossidabile - St. Steel

	Cm	In
V78 05 81 FCO1	14	5,1/2

**Denocciatore**

Olive and cherry pitter

Dénoyateur à olives Entkerner

Entkerner

Deshuesador aceitunas

Inox 18/10 - St. Steel

	Cm	In
V78 05 81 DEN	16,2	6,3/8



Coppa punch

Punch bowl
Bol à punch
Punchschale
Champañera

Inox 18/10 - St. Steel

	∅ Cm	∅ In	Lt	Oz
V77 05 52 PUN	40	15,3/4	13	439,5

**Coppa champagne con base**

Champagne-bottle holder with base
Coupe à champagne avec base
Champagnerschale mit Basis
Champañera con base

Inox 18/10 - St. Steel

	∅ Cm	∅ In	Lt	Oz
V77 05 52 PUN3	53	20,7/8	25	845

**Coppa punch doppio corpo**

Punch bowl double-wall
Bol à punch double paroi
Doppelwandiger Punchschale
Champañera doble pared

Inox 18/10 - St. Steel

	Cm	In	Lt	Oz
V77 05 52 PUN2	39	15,3/8	10	338

**Coppa champagne**

Champagne bottle holder
Coupe à champagne
Champagnerschale
Champañera

Inox 18/10 - St. Steel

	Cm	In	Lt	Oz
V77 05 52 PUN1	53	20,7/8	25	845



Cremiera Imperial

Imperial creampot
Crémier Imperial
Imperial Sahnekännchen
Jarrita de leche Imperial

Inox 18/10 - St. Steel

	Cl	Oz
V01 05 03 015	15	5

**Lattiera Imperial**

Imperial milkpot
Pot à lait Imperial
Imperial Milchkanne
Lechera Imperial

Inox 18/10 - St. Steel

	Cl	Oz
V01 05 03 035	35	12
V01 05 03 060	60	20
V01 05 03 100	100	35

**Porta cucchiaini**

Spoon holder
Porte-cuillères
Löffelbehälter
Portacucharillas

Inox 18/10 - St. Steel

	ø Cm	ø In	H Cm	H In
V01 05 71 008	9	3,1/2	8	3,1/8

**Portacannucce**

Straw holder
Porte-pailles
Trinkhalmbehälter
Porta pajitas

Inox 18/10 - St. Steel

	ø Cm	ø In	H Cm	H In
V01 05 71 011	9	3,1/2	11	4,3/8



Portacucchiaini a 3 posti Europa

Europa spoon holder, 3-sector
 Porte cuillères 3 secteurs Europa
 Kaffeeöffelständer 3 sektoren Europa
 Porta cucharitas 3 sectores Europa

Inox 18/10 - St. Steel

	Cm	In	H Cm	H In
CI 22202	27x8	10,5/8x3,1/8	8,5-10-12	3,3/8 - 4 - 4,3/4



Portacucchiaini a 2 posti Europa

Europa spoon holder, 2-sector
 Porte cuillères 2 secteurs Europa
 Kaffeeöffelständer 2 sektoren Europa
 Porta cucharitas 2 sectores Europa

Inox 18/10 - St. Steel

	Cm	In	H Cm	H In
CI 22201	17x8	6,3/4x3,1/8	8,5 - 10	3,3/8 - 4



Spargicacao con coperchio in plastica

Cocoa shaker with plastic cover
 Saupoudreuse de cacao à couvercle en plastique
 Kakaostreuer mit Plastikdeckel
 Espolvoreador con tapa en plástico

Inox 18/10 - St. Steel

	Ø Cm	Ø In
909 05 XX 028	5,3	2,1/8



Portabustine zucchero/tè

Packed sugar/tea holder
 Conteneur sachets de sucre/té
 Zucker und-Teebeutel Behälter
 Portasobres de azúcar/té

Inox 18/10 - St. Steel

	Cm	In	H Cm	H In
V78 05 04 PBU	10x6,5	3,7/8x2,1/2	3,5	1,3/8



Portatovaglioli Square

Napkin holder
 Porte-serviettes
 Serviettenhalter
 Servilletero

Inox 18/10 - St. Steel

	Cm	In	H Cm	H In
V76 05 71 001	11x4	4,3/8x1,2/3	2	3,1/8



Portatovaglioli da banco verticale

Vertical napkin holder
 Porte-serviettes vertical
 Vertikaler Thekenserviettenhalter
 Servilletero cuadrado vertical

Inox 18/10 - St. Steel

	Cm	In	H Cm	H In
906 05 008	8,5x11	3,3/8x4,3/8	16	6,1/4



Portabrioche singolo

Croissant tray

Plateau porte-croissants

Brot Büfettkorb

Bandeja de buffet

PP e SAN

	Cm	In	H Cm	H In
V77 12 52 01P	50x30,5	19,5/8x12,1/8	18,5	7,1/4
V77 12 52 03P	40x24,5	15,3x9,5/8	15,5	6,1/8

**Portabrioche doppio**

Double-deck croissant tray

Porte-croissants deux étages

Doppelsplatte Brot Büfettkorb

Bandeja de buffet con dos pisos

PP e SAN

	Cm	In	H Cm	H In
V77 12 52 02P	50x30,5	19,5/8x12,1/8	39	15,3/8

**Portabrioche tondo**

Round croissant tray

Porte-croissants rond

Brot Büfettkorb rund

Bandeja de buffet redonda

PP e SAN

	ø Cm	ø In
V77 12 52 0TP	46	18,1/8
V77 12 52 0TP1	38	15



Portaformaggi/affettati refrigerato singolo

Thermal food tray rectangular
 Porte-dîner rectangulaire réfrigérant individuel
 Wurstwarenplatte, rechteckig
 Bandeja portaquesos/embutados rectangular refrigerante individual

PP e SAN

	Cm	In	H Cm	H In
V77 12 54 01P	50x30,5	19,5/8x12,1/8	18,5	7,1/4



Portaformaggi/affettati refrigerato doppio

Thermal food tray rectangular, double
 Porte-dîner rectangulaire réfrigérant double
 Doppelwurstwarenplatte, rechteckig
 Bandeja portaquesos rectangular refrigerante doble

PP e SAN

	Cm	In	H Cm	H In
V77 12 54 02P	50x30,5	19,5/8x12,1/8	39	15,3/8



Eutettici rettangolari

Ice packs
 Blocs réfrigérants
 Kühllakkus
 Acumuladores de frío rectangulares

V77 12 95 G00



Base coprieutettici per portaformaggi refrigerato

Ice pack cover for termale rectangular cheese dish
 Base couvre blocs réfrigérants pour porte-dimer réfrigérant
 Kühllakkus scheinbe für Wurstwaremplate, rechteckig
 Base para acumuladores de frío para bandeja portaquesos refrigerante

Inox 18/10 - St. Steel

	Cm	In
Z77 19 54 01P	43,5x24	17,1/8x9,1/2





CUCINA • KITCHEN



I contenitori Gastronorm sono studiati e realizzati in conformità alla normativa UNI EN 631-1. Realizzati in AISI 304 (1.4301) per garantire un'ottima resistenza alla corrosione; l'AISI 304 è un acciaio austenitico che può essere utilizzato a contatto con gli alimenti secondo il decreto 11 Novembre 2013 Nr. 140.

Gastronorm containers are designed and manufactured in compliance with UNI EN 631-1 regulation. Made of AISI 304 (1.4301) to ensure an excellent corrosion resistance; AISI 304 is an austenitic steel that can be used in contact with food according to the Decree of 11 November 2013 No. 140.

Contenitore GN 1/1

GN 1/1 container
Conteneur GN 1/1
GN Behälter Edelstahl Gn 1/1
Contenedor GN 1/1

Inox 18/10 - St. Steel

	Cm	H Cm	Sp. M
V01 05 72 G11	53x32,5	2	0,7
V01 05 72 G11A	53x32,5	4	0,7
V01 05 72 G11B	53x32,5	6,5	0,7
V01 05 72 G11C	53x32,5	10	0,7
V01 05 72 G11D	53x32,5	15	0,7
V01 05 72 G11E	53x32,5	20	0,7

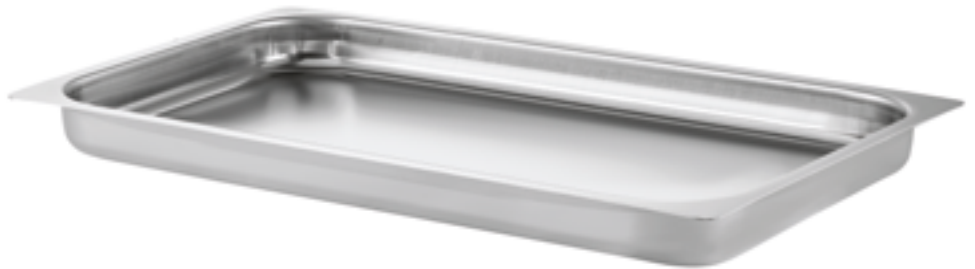

Contenitore GN 2/3

GN 2/3 container
Conteneur GN 2/3
GN Behälter Edelstahl Gn 2/3
Contenedor GN 2/3

Inox 18/10 - St. Steel

	Cm	H Cm	Sp. Mm
V01 05 72 G23	35,4x32,5	2	0,7
V01 05 72 G23A	35,4x32,5	4	0,7
V01 05 72 G23B	35,4x32,5	6,5	0,7
V01 05 72 G23C	35,4x32,5	10	0,7
V01 05 72 G23D	35,4x32,5	15	0,7
V01 05 72 G23E	35,4x32,5	20	0,7



Contenitore GN 1/2

GN 1/2 container
Conteneur GN 1/2
GN Behälter Edelstahl Gn 1/2
Contenedor GN 1/2

Inox 18/10 - St. Steel

	Cm	H Cm	Sp. Mm
V01 05 72 G12	32,5x26,5	2	0,7
V01 05 72 G12A	32,5x26,5	4	0,7
V01 05 72 G12B	32,5x26,5	6,5	0,7
V01 05 72 G12C	32,5x26,5	10	0,7
V01 05 72 G12D	32,5x26,5	15	0,7
V01 05 72 G12E	32,5x26,5	20	0,7



Contenitore GN 1/3

GN 1/3 container
 Conteneur GN 1/3
 GN Behälter Edelstahl Gn 1/3
 Contenedor GN 1/3

Inox 18/10 - St. Steel

	Cm	H Cm	Sp. Mm
V01 05 72 G13	32,5x17,6	2	0,7
V01 05 72 G13A	32,5x17,6	4	0,7
V01 05 72 G13B	32,5x17,6	6,5	0,7
V01 05 72 G13C	32,5x17,6	10	0,7
V01 05 72 G13D	32,5x17,6	15	0,7
V01 05 72 G13E	32,5x17,6	20	0,7



Contenitore GN 1/4

GN 1/4 container
 Conteneur GN 1/4
 GN Behälter Edelstahl Gn 1/4
 Contenedor GN 1/4

Inox 18/10 - St. Steel

	Cm	H Cm	Sp. Mm
V01 05 72 G14	26,5x16,2	2	0,7
V01 05 72 G14A	26,5x16,2	4	0,7
V01 05 72 G14B	26,5x16,2	6,5	0,7
V01 05 72 G14C	26,5x16,2	10	0,7
V01 05 72 G14D	26,5x16,2	15	0,7



Contenitore GN 1/6

GN 1/6 container
 Conteneur GN 1/6
 GN Behälter Edelstahl Gn 1/6
 Contenedor GN 1/6

Inox 18/10 - St. Steel

	Cm	H Cm	Sp. Mm
V01 05 72 G16	17,6x16,2	2	0,7
V01 05 72 G16A	17,6x16,2	4	0,7
V01 05 72 G16B	17,6x16,2	6,5	0,7
V01 05 72 G16C	17,6x16,2	10	0,7
V01 05 72 G16D	17,6x16,2	15	0,7



Contenitore GN 1/9

GN 1/9 container
 Conteneur GN 1/9
 GN Behälter Edelstahl Gn 1/9
 Contenedor GN 1/9

Inox 18/10 - St. Steel

	Cm	H Cm	Sp. Mm
V01 05 72 G19A	17,6x10,8	4	0,7
V01 05 72 G19B	17,6x10,8	6,5	0,7
V01 05 72 G19C	17,6x10,8	10	0,7



Teglia GN 1/1

1/1 GN baking pan

Plat à four GN 1/1

Gastronorm-Blech Edelstahl GN 1/1

Fuente para horno GN 1/1

Inox 18/10 - St. Steel

	Cm	H Cm	Sp. Mm
V01 05 26 G11	53x32,5	2	0,7
V01 05 26 G11A	53x32,5	4	0,7
V01 05 26 G11B	53x32,5	6,5	0,7

**Teglia GN 2/3**

2/3 GN baking pan

Plat à four GN 2/3

Gastronorm-Blech Edelstahl GN 2/3

Fuente para horno GN 2/3

Inox 18/10 - St. Steel

	Cm	H Cm	Sp. Mm
V01 05 26 G233	35,4x32,5	2	0,7
V01 05 26 G23A	35,4x32,5	4	0,7
V01 05 26 G23B	35,4x32,5	6,5	0,7

**Teglia GN 1/2**

1/2 GN baking pan

Plat à four GN 1/2

Gastronorm-Blech Edelstahl GN 1/2

Fuente para horno GN 1/2

Inox 18/10 - St. Steel

	Cm	H Cm	Sp. Mm
V01 05 26 G12	32,5x26,5	2	0,7
V01 05 26 G12A	32,5x26,5	4	0,7
V01 05 26 G12B	32,5x26,5	6,5	0,7



Coperchio GN

GN lid
Couvercle GN
GN Deckel
Tapa GN

**Inox 18/10 - St. Steel**

	GN	Cm	Sp. Mm
V01 05 15 G11	1/1	53x32,5	0,7
V01 05 15 G23	2/3	35,4x32,5	0,7
V01 05 15 G12	1/2	32,5x26,5	0,7
V01 05 15 G13	1/3	32,5x17,6	0,7
V01 05 15 G14	1/4	26,5x16,2	0,7
V01 05 15 G16	1/6	17,6x16,2	0,7
V01 05 15 G19	1/9	17,6x10,8	0,7

Con asola/with hole

	GN	Cm	Sp. Mm
V01 05 15 GS11	1/1	53x32,5	0,7
V01 05 15 GS23	2/3	35,4x32,5	0,7
V01 05 15 GS12	1/2	32,5x26,5	0,7
V01 05 15 GS13	1/3	32,5x17,6	0,7
V01 05 15 GS14	1/4	26,5x16,2	0,7
V01 05 15 GS16	1/6	17,6x16,2	0,7
V01 05 15 GS19	1/9	17,6x10,8	0,7

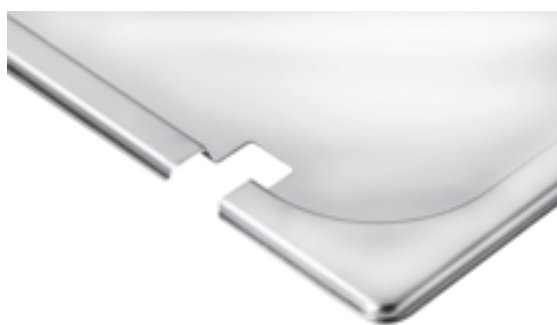
**Separatore GN**

GN adaptor bars
GN Barrette de composition
Separator GN
Perfiles divisorios GN

Inox 18/10 - St. Steel

	GN
V01 05 72 SE 11	1/1
V01 05 72 SE 12	1/2

**Falso fondo forato**

False perforated bottom
Faux fond perforé
Flascher Boden mit Löchern
Falso fondo perforado

Inox 18/10 - St. Steel

	GN
V01 05 72 FF 11	1/1
V01 05 72 FF 12	1/2
V01 05 72 FF 23	2/3



Bacinella forata (fondo + lati)

Perforated basin (bottom + sides)

Bacs perforè (fond + côtés)

Schüssel mit Löchern (Boden + seiten)

Bandejas honda perforada (fondo y lados)

Inox 18/10 - St. Steel

	H Cm	H In	GN
V01 05 72 GF 11BL	6,5	2,1/2	1/1
V01 05 72 GF 11C	10	4	1/1
V01 05 72 GF 11D	15	6	1/1
V01 05 72 GF 11E	20	7,7/8	1/1
V01 05 72 GF 11EM	20	7,7/8	1/1
V01 05 72 GF 23C	10	4	2/3
V01 05 72 GF 23D	15	6	2/3
V01 05 72 GF 23E	20	7,7/8	2/3
V01 05 72 GF 12C	10	4	1/2
V01 05 72 GF 12D	15	6	1/2
V01 05 72 GF 12E	20	7,7/8	1/2
V01 05 72 GF 13C	10	4	1/3
V01 05 72 GF 13D	15	6	1/3
V01 05 72 GF 13E	20	7,7/8	1/3



con maniglie/with handles

Bacinella forata (solo fondo)

Perforated basin (bottom only)

Bacs perforè (fond seulement)

Schüssel mit Löchern (nur Boden)

Bandejas honda perforada (solo el fondo)

Inox 18/10 - St. Steel

	H Cm	H In	GN
V01 05 72 GF 11	2	0,3/4	1/1
V01 05 72 GF 11A	4	1,1/2	1/1
V01 05 72 GF 11B	6,5	2,1/2	1/1
V01 05 72 GF 23	2	0,3/4	2/3
V01 05 72 GF 23A	4	1,1/2	2/3
V01 05 72 GF 23B	6,5	2,1/2	2/3
V01 05 72 GF 12	2	0,3/4	1/2
V01 05 72 GF 12A	4	1,1/2	1/2
V01 05 72 GF 12B	6,5	2,1/2	1/2
V01 05 72 GF 13	2	0,3/4	1/3
V01 05 72 GF 13A	4	1,1/2	1/3
V01 05 72 GF 13B	6,5	2,1/2	1/3



Contenitore GN 1/1

GN 1/1 container
 Conteneur GN 1/1
 GN Behälter GN 1/1
 Contenedor GN 1/1

Policarbonato - Polycarbonate

	Cm	H Cm
V01 PC 72 G11 B	53x32,5	6,5
V01 PC 72 G11 C	53x32,5	10
V01 PC 72 G11 D	53x32,5	15
V01 PC 72 G11 E	53x32,5	20



Contenitore GN 1/2

GN 1/2 container
 Conteneur GN 1/2
 GN Behälter GN 1/2
 Contenedor GN 1/2

Policarbonato - Polycarbonate

	Cm	H Cm
V01 PC 72 G12 B	32,5x26,5	6,5
V01 PC 72 G12 C	32,5x26,5	10
V01 PC 72 G12 D	32,5x26,5	15
V01 PC 72 G12 E	32,5x26,5	20



Contenitore GN 1/3

GN 1/3 container
 Conteneur GN 1/3
 GN Behälter GN 1/3
 Contenedor GN 1/3

Policarbonato - Polycarbonate

	Cm	H Cm
V01 PC 72 G13 B	32,5x17,6	6,5
V01 PC 72 G13 C	32,5x17,6	10
V01 PC 72 G13 D	32,5x17,6	15



Contenitore GN 1/4

GN 1/4 container
 Conteneur GN 1/4
 GN Behälter GN 1/4
 Contenedor GN 1/4

Policarbonato - Polycarbonate

	Cm	H Cm
V01 PC 72 G14 B	26,5x16,2	6,5
V01 PC 72 G14 C	26,5x16,2	10
V01 PC 72 G14 D	26,5x16,2	15



Contentitore GN 1/6

GN 1/6 container
 Conteneur GN 1/6
 GN Behälter GN 1/6
 Contenedor GN 1/6

Policarbonato - Polycarbonate

	Cm	H Cm
V01 PC 72 G16 B	17,6x16,2	6,5
V01 PC 72 G16 C	17,6x16,2	10
V01 PC 72 G16 D	17,6x16,2	15

**Contentitore GN 1/9**

GN 1/9 container
 Conteneur GN 1/9
 GN Behälter GN 1/9
 Contenedor GN 1/9

Policarbonato - Polycarbonate

	Cm	H Cm
V01 PC 72 G19 B	17,6x10,8	6,5
V01 PC 72 G19 C	17,6x10,8	10
V01 PC 72 G19 D	17,6x10,8	15

**Vaschetta gelato GN**

GN ice cream pan
 Bac à glace GN
 Eisschale GN
 Cubeta helado GN

Policarbonato - Polycarbonate

	Cm	H Cm
V01 PC 72 GGE	16,8x35,5	11



Coperchio

Lid
Couvercle
Deckel
Tapa

Policarbonato - Polycarbonate

	Cm	GN
V01 PC 15 G11	53x32,5	1/1
V01 PC 15 G12	32,5x26,5	1/2
V01 PC 15 G13	32,5x17,6	1/3
V01 PC 15 G14	26,5x16,2	1/4
V01 PC 15 G16	17,6x16,2	1/6
V01 PC 15 G19	17,6x10,8	1/9

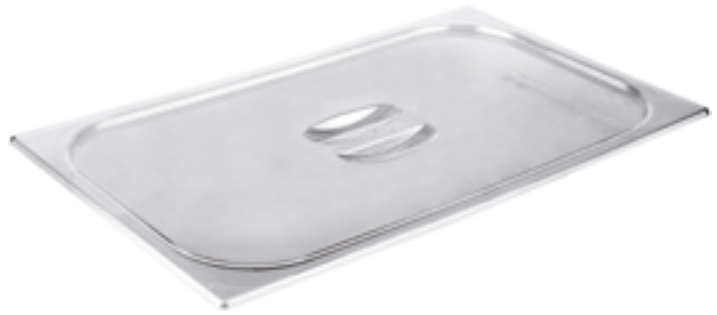

Coperchio GN ermetico

GN hermetic lid
Couvercle hermétique GN
Hermetische Deckel GN
Tapa GN hermética

Policarbonato - Polycarbonate

	GN	Cm
V01 PC 15 GE11	1/1	53x32,5
V01 PC 15 GE12	1/2	32,5x26,5



Coperchio

Lid
Couvercle
Deckel
Tapa

Polipropilene - Polypropylene

	Cm	GN
V01 PP 15 G11	53x32,5	1/1
V01 PP 15 G12	32,5x26,5	1/2
V01 PP 15 G13	32,5x17,6	1/3
V01 PP 15 G14	26,5x16,2	1/4
V01 PP 15 G16	17,6x16,2	1/6
V01 PP 15 G19	17,6x10,8	1/9



**Contentitore GN 1/1**

GN 1/1 container
 Conteneur GN 1/1
 GN Behälter Gn 1/1
 Contenedor GN 1/1

Polipropilene - Polypropylene

	Cm	H Cm
V01 PP 72 G11 B	53x32,5	6,5
V01 PP 72 G11 C	53x32,5	10
V01 PP 72 G11 D	53x32,5	15
V01 PP 72 G11 E	53x32,5	20

**Contentitore GN 1/2**

GN 1/2 container
 Conteneur GN 1/2
 GN Behälter Gn 1/2
 Contenedor GN 1/2

Polipropilene - Polypropylene

	Cm	H Cm
V01 PP 72 G12 B	32,5x26,5	6,5
V01 PP 72 G12 C	32,5x26,5	10
V01 PP 72 G12 D	32,5x26,5	15
V01 PP 72 G12 E	32,5x26,5	20

**Contentitore GN 1/3**

GN 1/3 container
 Conteneur GN 1/3
 GN Behälter Gn 1/3
 Contenedor GN 1/3

Polipropilene - Polypropylene

	Cm	H Cm
V01 PP 72 G13 B	32,5x17,6	6,5
V01 PP 72 G13 C	32,5x17,6	10
V01 PP 72 G13 D	32,5x17,6	15

**Contentitore GN 1/4**

GN 1/4 container
 Conteneur GN 1/4
 GN Behälter Gn 1/4
 Contenedor GN 1/4

Polipropilene - Polypropylene

	Cm	H Cm
V01 PP 72 G14 B	26,5x16,2	6,5
V01 PP 72 G14 C	26,5x16,2	10
V01 PP 72 G14 D	26,5x16,2	15

Contentore GN 1/6

GN 1/6 container
 Conteneur GN 1/6
 GN Behälter Gn 1/6
 Contenedor GN 1/6

Polipropilene - Polypropylene

	Cm	H Cm
V01 PP 72 G16 B	17,6x16,2	6,5
V01 PP 72 G16 C	17,6x16,2	10
V01 PP 72 G16 D	17,6x16,2	15



Contentore GN 1/9

GN 1/9 container
 Conteneur GN 1/9
 GN Behälter Gn 1/9
 Contenedor GN 1/9

Polipropilene - Polypropylene

	Cm	H Cm
V01 PP 72 G19 B	17,6x10,8	6,5
V01 PP 72 G19 C	17,6x10,8	10
V01 PP 72 G19 D	17,6x10,8	15



Vaschetta gelato GN

GN ice cream pan
 Bac à glace GN
 Eisschale, übereinander legbar
 Cubeta helado GN

Polipropilene - Polypropylene

	Cm	H Cm
V01 PP 72 GGE	16,8x35,5	11



Trinciapollo manico pom rivettato

Shears, pom riveted handle
 Ciseaux à volailles manche POM riveté
 Geflügel Schere mit genietetem Heft
 Tijeras para aves mango pom remachado

Acciaio inossidabile - St. Steel

AVARI 110

**Trinciapollo manico cavo**

Shears, hollow handle
 Tijeras para aves mango hueco
 Geflügel Schere mit hohem Heft
 Ciseaux à volailles manche creuse

Acciaio inox AISI 420

AVARI 111

**Grattugia acciaio inox 4 facce**

4-side inox grater
 Râpe inox 4 faces
 4 Seiten Reibeisen
 Rallador acero 4 lados

Acciaio inossidabile - St. Steel

AVARI 063

**Olierona**

Oil dispenser
 Huilière
 Ölbehälter
 Aceitera grande

Acciaio inossidabile - St. Steel

	Lt
AVARI 071	0,5
AVARI 072	1,0

**Spillone pizzeria**

Pizza pin
 Épingle pour commandes pizzeria
 Pizzeria Stecknadel
 Agujón para hojas pedidos pizzeria

Acciaio inossidabile - St. Steel

AVARI 086

**Campanello reception**

Reception bell
 Sonette de réception
 Hotelglocke
 Timbre recepción

Acciaio inossidabile - St. Steel

AVARI 112



Schiumarola unipezzo

Skimmer, one piece
 Ecumoire en une pièce
 Schaumlöffel einteilig
 Espumadera de una sola pieza

Acciaio inossidabile - St. Steel

	∅ Cm	∅ In
903 06 81 US1	11	4,3/8
903 06 81 US3	13	5,1/8

**Mestolo unipezzo**

Soup, one piece
 Louche en une pièce
 Schopflöffel einteilig
 Cazo sopa de una sola pieza

Acciaio inossidabile - St. Steel

	∅ Cm	∅ In
903 06 81 UM9	9	3,1/2
903 06 81 UM1	10	4

**Mestolino unipezzo**

Sauce ladle, one piece
 Louche à sauce en une pièce
 Schopflöffel klein einteilig
 Cacillo salsa de una sola pieza

Acciaio inossidabile - St. Steel

	L Cm	L In
903 06 81 UMS	28	11

**Pala fritto unipezzo**

Frying palette, one piece
 Pelle frittura en une pièce
 Schaufel einteilig
 Pala frito de una sola pieza

Acciaio inossidabile - St. Steel

	L Cm	L In
903 06 81 UFR	36,5	14,3/8

**Cucchiaione unipezzo**

Serving spoon, one piece
 Cuillère à servir en une pièce
 Löffel einteilig
 Cucharón servir de una sola pieza

Acciaio inossidabile - St. Steel

	L Cm	L In
903 06 81 UCU	40	15,3/4

**Forchettone unipezzo**

Serving fork, one piece
 Fourchette à servir en une pièce
 Gabel einteilig
 Tenedor servir de una sola pieza

Acciaio inossidabile - St. Steel

	L Cm	L In
903 06 81 UFO	36	14,1/8



Molla ghiaccio de luxe

De luxe ice tongs
Pince à glaçons de luxe
Eiszange de luxe
Pinzas hielo de luxe

Acciaio inossidabile - St. Steel

	Cm	In
903 06 81 MGD	15,6	6,1/8

**Molla pane**

Bread tongs
Pince à pain
Brotzange
Pinzas pan

Acciaio inossidabile - St. Steel

	Cm	In
903 06 81 MPA	20	7,7/8

**Molla spaghetti**

Spaghetti tongs
Pince à spaghetti
Spaghetizange
Pinzas spaghetti

Acciaio inossidabile - St. Steel

	Cm	In
903 06 81 MSP	20,2	7,7/8

**Molla dolci**

Cake tongs
Pince à gâteau
Gebäckzange
Pinzas postre

Acciaio inossidabile - St. Steel

	Cm	In
903 06 81 MDL	18,9	7,1/2

**Molla arrosto**

Roast tongs
Pince à rôti
Fleisch/Servierzange
Pinzas asado

Acciaio inossidabile - St. Steel

	Cm	In
903 06 81 MAR	21	8,1/4

**Molla universale**

Universal tongs
Pince universelle
Universalzange
Pinzas universales

Acciaio inossidabile - St. Steel

	Cm	In
903 06 81 MUN	23,5	9,1/4



Molla zucchero

Sugar tongs
Pince à sucre
Zuckerzange
Pinzas azucar

Acciaio inossidabile - St. Steel

	Cm	In
903 06 81 MZU	14,1	5,1/2

**Molla ghiaccio piccola**

Small ice tongs
Pince à glaçons petite
Eiszange - klein
Pinzas hielo pequeñas

Acciaio inossidabile - St. Steel

	Cm	In
903 06 81 MGP	11,8	4,3/4

**Forbici insalata**

Salad tongs (scissors type)
Pince ciseaux à salade
Salatzange
Pinzas ensalada tipo tijeras

Acciaio inossidabile - St. Steel

	Cm	In
903 06 81 FIN	20	7,7/8

**Forbici dolci**

Cake tongs (scissors type)
Pince ciseaux à gâteaux
Scherenzange
Pinzas postre tipo tijeras

Acciaio inossidabile - St. Steel

	Cm	In
903 06 81 FDO	19,5	7,5/8

**Molla affettati**

Salami tongs
Pince charcuterie
Wurstwarenfeder
Pinzas charcutería

Acciaio inossidabile - St. Steel

	Mm	In
903 05 81 MAF C1	105	4,1/8





Bastardella

Bowl
Bol
Edelstahl 18/10 Schale "Bastardella"
Bol

Acciaio Inox 18/10 - St.steel

	∅ Cm	H Cm	∅ In	H In
V01 05 43 B 26	26	16,2	10,1/4	6,1/4
V01 05 43 B 22	22	16,2	8,5/8	6,1/4



Supporto per bastardella

Bowl stand
Support pour bol
Halter fuer Schale
Soparte para bol

Acciaio Inox 18/10 - St.steel

	∅ Cm	H Cm	∅ In	H In
Z01 19 43 B 22	16	3	6,1/4	1,1/8



Ciotola

Bowl
Bol
Bol
Schale

Acciaio inossidabile - St. Steel

	Ø Cm	Ø In	Lt
AVARI 049	12	4,3/4	0,5
AVARI 052	16	6,1/4	1
AVARI 050	20	7,7/8	2
AVARI 053	23	9,8/8	3
AVARI 051	26	10,1/4	4

**Lasagnera**

Lasagna tray
Plat à four
Lasagne-pfanne
Lasañera

Acciaio inossidabile - St. Steel

	Cm	In
V03 06 26 026	26,5x19,5	10,3/8x7,5/8
V03 06 26 031	31,5x24	12,3/8x9,1/2
V03 06 26 037	37x27	14,1/2x10,5/8
V03 06 26 040	42x30,5	16,1/2x12

**Vassoio pasticceria**

Confectionery tray
Plateau à pâtisserie
Konditoreiplatte
Bandeja p/pasteleria

Acciaio inossidabile - St. Steel

	Cm	In
CI 5601	25x18	9,7/8x7
CI 5602	30x22	11,3/4x8,5/8

**Carapina Professionale**

Professional Carapina
Carapina professionnelle
Carapina
Carapina profesionales

Acciaio inossidabile - St. Steel

	Ø Cm	H Cm	Ø In	H In
V01 05 72 GGE	20	23,5	7,7/8	9,1/4



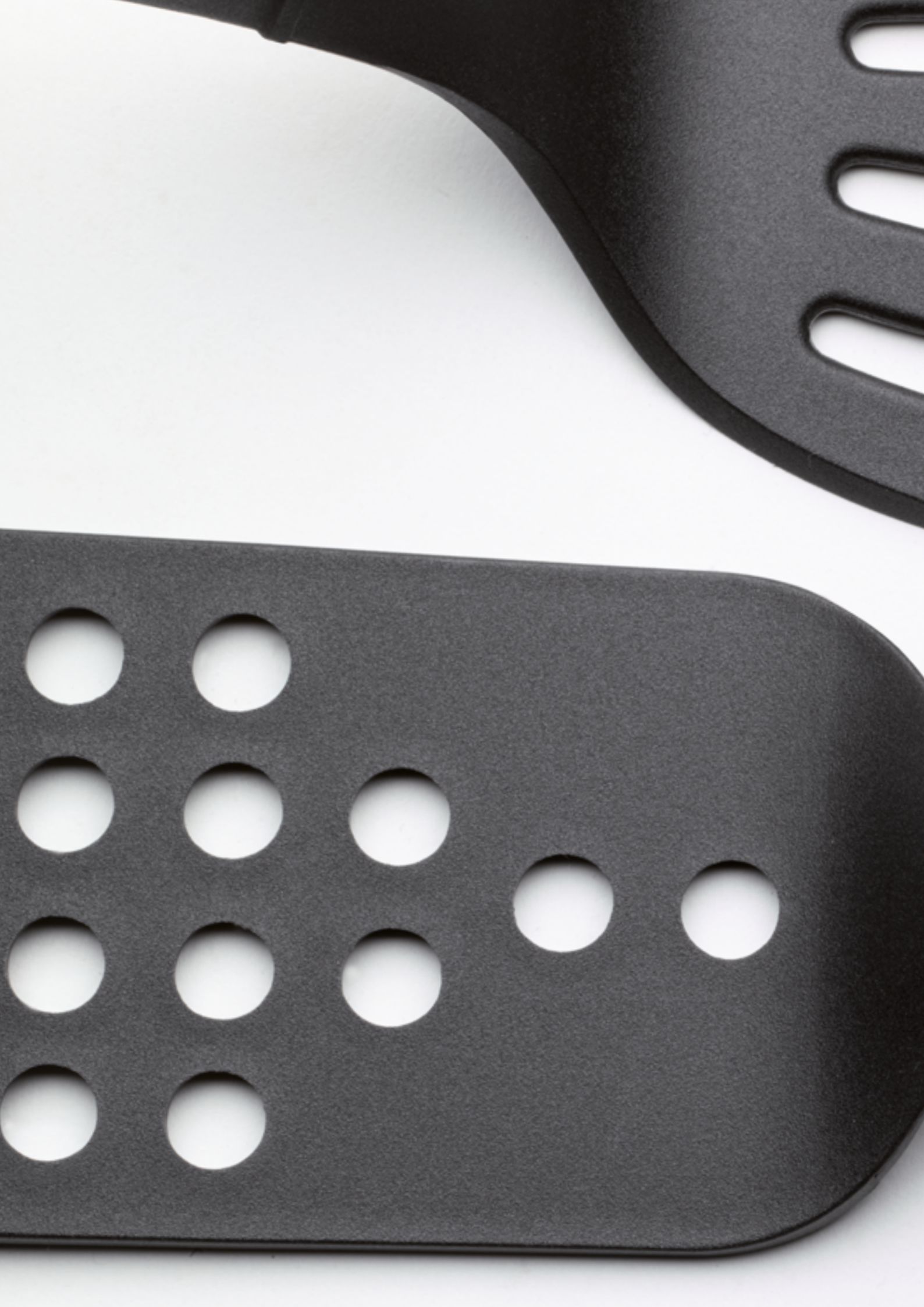



● PROMAB

Mestolo Cucinart

Cucinart ladle
Louche Cucinart
Suppenlöffel Cucinart
Cazo Cucinart

Nylon

	Cm	In
● 903 12 81 C15 ME	32	12,5/8
● 903 12 81 C47 ME	32	12,5/8

**Cucchiaione forato Cucinart**

Cucinart slotted spoon
Cuillère à servir perforée Cucinart
Gelochte Servierlöffel Cucinart
Cucharòn perforado Cucinart

Nylon

	Cm	In
● 903 12 81 C15 CUF	35	13,3/4
● 903 12 81 C47 CUF	35	13,3/4

**Paletta Cucinart**

Cucinart shovel
Pelle Cucinart
Schaufel Cucinart
Pala Cucinart

Nylon

	Cm	In
● 903 12 81 C15 PA1	35	13,3/4
● 903 12 81 C47 PA1	35	13,3/4

**Servispaghetti Cucinart**

Cucinart spaghetti serving spoon
Louche à spaghetti Cucinart
Servierlöffel fuer spaghetti Cucinart
Cucharòn para spaghetti Cucinart

Nylon

	Cm	In
● 903 12 81 C15 SP	33,4	13,1/4
● 903 12 81 C47 SP	33,4	13,1/4

**Schiumarola Cucinart**

Cucinart skimmer
Ecumoire Cucinart
Schaumlöffel Cucinart
Espumadera Cucinart

Nylon

	Cm	In
● 903 12 81 C15 SC	35	13,3/4
● 903 12 81 C47 SC	35	13,3/4

**Cucchiaione Cucinart**

Cucinart serving spoon
Cuillère à servir Cucinart
Servierlöffel Cucinart
Cucharòn Cucinart

Nylon

	Cm	In
● 903 12 81 C15 CU	35	13,3/4
● 903 12 81 C47 CU	35	13,3/4

**Pala fritto Cucinart**

Cucinart frying shovel
Pelle à friture Cucinart
Schaufel Cucinart
Pala para freir Cucinart

Nylon

	Cm	In
● 903 12 81 C15 FR	35	13,3/4
● 903 12 81 C47 FR	35	13,3/4

**Paletta Cucinart**

Cucinart shovel
Pelle Cucinart
Schaufel Cucinart
Pala Cucinart

Nylon

	Cm	In
● 903 12 81 C15 PA2	32	12,5/8
● 903 12 81 C47 PA2	32	12,5/8



Paletta forata Cucinart

Cucinart perforated shovel
 Pelle perforée Cucinart
 Gelochte Schaufel Cucinart
 Pala perforada Cucinart

Nylon

	Cm	In
● 903 12 81 C15 PAF	31	12,1/4
● 903 12 81 C47 PAF	31	12,1/4



Paletta fritto Cucinart

Cucinart frying shovel
 Pelle à friture Cucinart
 Schaufel Cucinart
 Pala para freir Cucinart

Nylon

	Cm	In
● 903 12 81 C15 PAA	31	12,1/4
● 903 12 81 C47 PAA	31	12,1/4



Molla insalata Cucinart

Cucinart salad tongs
 Pince à salade Cucinart
 Salatschaufel Cucinart
 Pinzas ensalada Cucinart

Nylon

	Cm	In
● 903 12 81 C15 MI	31	12,1/4
● 903 12 81 C47 MI	31	12,1/4



Molla dolce Cucinart

Cucinart cake tongs
 Pince à gâteaux Cucinart
 Kuchenschaufel Cucinart
 Pinzas postre Cucinart

Nylon

	Cm	In
● 903 12 81 C15 MD	28	11
● 903 12 81 C47 MD	28	11



Pinza chef Cucinart

Cucinart chef tongs
 Pince chef Cucinart
 Chef Zange Cucinart
 Pinzas de chef Cucinart

Nylon

	Cm	In
● 903 12 81 C15 PI	30,5	12
● 903 12 81 C47 PI	30,5	12



Paletta scolatutto Cucinart

Cucinart draining spoon
 Cuillère à égoutter Cucinart
 Schaumschaufel Cucinart
 Cuchara para colar Cucinart

Nylon

	Cm	In
● 903 12 81 C15 PFG	30,5	12
● 903 12 81 C47 PFG	30,5	12



Coltello Chef Cucinart

Cucinart chef knife
 Couteau chef Cucinart
 Chefmesser Cucinart
 Cuchillo cocinero Cucinart

Acciaio inossidabile - St. Steel+ ABS

	Cm	In
V67 06 91 001	15	6
V67 06 91 002	20	7,7/8
V67 06 91 025	23	9
V67 06 91 026	25	9,7/8

**Coltello pane Cucinart**

Cucinart Bread knife
 Couteau pain Cucinart
 Brottmesser Cucinart
 Cuchillo pan Cucinart

Acciaio inossidabile - St. Steel+ ABS

	Cm	In
V67 06 91 003	20	7,7/8

**Coltello affettare Cucinart**

Cucinart slicing knife
 Couteau pour coupe en tranches Cucinart
 Messer zum aufschneiden Cucinart
 Cuchillo para filetear Cucinart

Acciaio inossidabile - St. Steel+ ABS

	Cm	In
V67 06 91 004	20	7,7/8

**Coltello Utility Cucinart**

Cucinart Utility knife
 Couteau de service Cucinart
 Utility-Messer Cucinart
 Cuchillo universal Cucinart

Acciaio inossidabile - St. Steel+ ABS

	Cm	In
V67 06 91 009	14	5,1/2

**Coltello Santoku Cucinart**

Cucinart Santoku knife
 Couteau Santoku Cucinart
 Santoku Profimesser Cucinart
 Cuchillo Santoku Cucinart

Acciaio inossidabile - St. Steel+ ABS

	Cm	In
V67 06 91 005	12,5	5
V67 06 91 006	16	6,1/4

**Coltello disossare Cucinart**

Cucinart boning knife
 Couteau à désosser Cucinart
 Messer zum Entbeinen Cucinart
 Cuchillo deshuesador Cucinart

Acciaio inossidabile - St. Steel+ ABS

	Cm	In
V67 06 91 007	16	6,1/4



Mannaretta Cucinart

Cucinart cleaver
Couperet Cucinart
Hackbeil Messer Cucinart
Cuchillo de carnicero Cucinart

Acciaio inossidabile - St. Steel+ ABS

	Cm	In
V67 06 91 027	18	7

**Affilacoltelli Cucinart**

Cucinart knife sharpener
Aiguiseur à couteaux Cucinart
Schleifmittel Cucinart
Afilador de cuchillos Cucinart

Acciaio inossidabile - St. Steel+ ABS

	Cm	In
V67 06 91 012	20	7,7/8

**Coltello Utility seghettato Cucinart**

Cucinart serrated Utility knife
Couteau de service dentelé Cucinart
Utility-Messer Wellenschlif Cucinart
Cuchillo universal dentado Cucinart

Acciaio inossidabile - St. Steel+ ABS

	Cm	In
V67 06 91 008	11,5	4,1/2

**Coltello spelucchino Cucinart**

Cucinart paring knife
Couteau à éplucher Cucinart
Schälmesser Cucinart
Cuchillo guarnecer Cucinart

Acciaio inossidabile - St. Steel+ ABS

	Cm	In
V67 06 91 010	8,8	3,1/2

**Coltello frutta Cucinart**

Cucinart dessert knife
Couteau à dessert/fruits Cucinart
Obstmesser Cucinart
Cuchillo frutas Cucinart

Acciaio inossidabile - St. Steel+ ABS

	Cm	In
V67 06 91 011	8,8	3,1/2



Padella Cucinart

Cucinart frying pan

Poêle Cucinart

Pfanne Cucinart

Sartén Cucinart

Alluminio con fondo a induzione**Aluminium with induction bottom**

	∅ Cm	∅ In	H Cm	H In
V67 11 72 PA24	24	9,1/2	6	2,3/8
V67 11 72 PA28	28	11	7	2,3/4
V67 11 72 PA32	32	12,5/8	7,5	3
V67 11 72 PA36	36	14,1/8	8	3,1/8
V67 11 72 PA40	40	15,3/4	8,5	3,3/8

**Pentola Cucinart**

Cucinart pot

Casserole Cucinart

Topf Cucinart

Olla Cucinart

Alluminio con fondo a induzione**Aluminium with induction bottom**

	∅ Cm	∅ In	H Cm	H In	Lt	Oz
V67 11 72 PE28	28	11	15	6	8	270
V67 11 72 CA32	32	12,5/8	11,5	4,1/2	9	304

casseruola | casserole

**Tegame Cucinart**

Cucinart frying pan, two handle

Poêlon avec 2 manches Cucinart

Flache Kochtopf Cucinart

Olla dos mangos Cucinart

Alluminio con fondo a induzione**Aluminium with induction bottom**

	∅ Cm	∅ In	H Cm	H In
V67 11 72 TE24	24	9,1/2	6	2,3/8
V67 11 72 TE28	28	11	7	2,3/4
V67 11 72 TE32	32	12,5/8	7,5	3
V67 11 72 TE36	36	14,1/8	8	3,1/8
V67 11 72 TE40	40	15,3/4	8,5	3,3/8



Padella Cucinart

Cucinart frying pan, non-stick
 Poêle Cucinart antiadhérente
 Pfanne Cucinart
 Sartén Cucinart antiadherente

Alluminio con fondo a induzione**Aluminium with induction bottom**

	∅ Cm	∅ In	H Cm	H In
V68 11 72 PA24	24	9,1/2	6	2,3/8
V68 11 72 PA28	28	11	7	2,3/4
V68 11 72 PA32	32	12,5/8	7,5	3
V68 11 72 PA36	36	14,1/8	8	3,1/8
V68 11 72 PA40	40	15,3/4	8,5	3,3/8

**Pentola Cucinart**

Cucinart pot, non-stick
 Casserole Cucinart antiadhérente
 Topf Cucinart
 Olla Cucinart antiadherente

Alluminio con fondo a induzione**Aluminium with induction bottom**

	∅ Cm	∅ In	H Cm	H In	Lt	Oz
V68 11 72 PE28	28	11	15	6	8	270
V68 11 72 CA32	32	12,5/8	11,5	4,1/2	9	304

casseruola | casserole

**Tegame Cucinart antiaderente**

Cucinart pot
 Casserole Cucinart
 Flache Kochtopf Cucinart
 Olla Cucinart

Alluminio con fondo a induzione**Aluminium with induction bottom**

	∅ Cm	∅ In	H Cm	H In
V68 11 72 TE24	24	9,1/2	6	2,3/8
V68 11 72 TE28	28	11	7	2,3/4
V68 11 72 TE32	32	12,5/8	7,5	3
V68 11 72 TE36	36	14,1/8	8	3,1/8
V68 11 72 TE40	40	15,3/4	8,5	3,3/8



Cestino pane

Square bread basket
Corbeille à pain carré
Viereckiger Brotkorb
Cesta pan cuadrado

	Cm	H Cm	In	H In
Marrone - Brown				
AVARI 200	14x14	8	5,1/2x5,1/2	3,1/8
AVARI 203	19x19	10	7,1/2x7,1/2	4
Beige - Ecrù				
AVARI 201	14x14	8	5,1/2x5,1/2	3,1/8
AVARI 204	19x19	10	7,1/2x7,1/2	4
Juta - Juta				
AVARI 202	14x14	8	5,1/2x5,1/2	3,1/8
AVARI 205	19x19	10	7,1/2x7,1/2	4

**Sacchetto porta pane**

Bread basket
Corbeille à pain
Brotkorb
Cesta pan

	Ø Cm	H Cm	Ø In	H In
Marrone - Brown				
AVARI 206	21	25	8,1/4	9,7/8
Beige - Ecrù				
AVARI 207	21	25	8,1/4	9,7/8

**Cuscino termico**

Thermal cushion
Coussin chauffant
Wärmekissen
Cojín térmico

	Cm	In
325 05 24 579	13x13	5,1/8x5,1/8
325 05 24 580	18x18	7x7



Cestino pane

Bread basket
Corbeille à pain
Brotkorb
Cesta pan

	Cm	H Cm	In	H In
Marrone - Brown				
305 29 24 581	12x12	14,5	5x5	5,3/4
305 29 24 582	18x18	18	7x7	7
Beige - Ecrù				
305 29 24 583	12x12	14,5	5x5	5,3/4
305 29 24 584	18x18	18	7x7	7

Cuscino termico

Thermal cushion
Coussin chauffiant
Wärmekissen
Cojín térmico

	Cm	In
325 05 24 579	13x13	5,1/8x5,1/8
325 05 24 580	18x18	7x7



Cestino pane tessuto con cuscino

Bread basket with cushion
Corbeille à pain avec coussin
Brotkorb mit Kissen
Cesta pan con cosin

	Cm	H Cm	In	H In
Marrone - Brown				
AVARI 151	12x12	14,5	5x5	5,3/4
AVARI 153	18x18	18	7x7	7
Beige - Ecrù				
AVARI 150	12x12	14,5	5x5	5,3/4
AVARI 152	18x18	18	7x7	7



Cestino pane tessuto (senza cuscino)

Bread basket (without cushion)
Corbeille à pain (sans coussin)
Brotkorb (ohne Kissen)
Cesta pan (sin cosin)

	Cm	H Cm	In	H In	Pz - Pcs
Marrone - Brown					
AVARI 162	12x12	14,5	5x5	5,3/4	1
AVARI 164	18x18	18	7x7	7	1
Beige - Ecrù					
AVARI 161	12x12	14,5	5x5	5,3/4	1
AVARI 163	18x18	18	7x7	7	1
Marrone - Brown					
AVARI 154	12x12	14,5	5x5	5,3/4	3
AVARI 156	18x18	18	7x7	7	2
Beige - Ecrù					
AVARI 155	12x12	14,5	5x5	5,3/4	3
AVARI 157	18x18	18	7x7	7	2



Brocca ColorStyle

ColorStyle jug

Broc à eau ColorStyle

Acryl Kanne Colorstyle

Jarra ColorStyle

Acrilico / Acrilic

	Lt	Oz
<input type="checkbox"/> V60 12 08 001 13	1,5	50,7
<input type="checkbox"/> V60 12 08 001 47	1,5	50,7
<input checked="" type="checkbox"/> V60 12 08 001 00	1,5	50,7

**Caraffa ColorStyle**

ColorStyle Pitcher

Carafe ColorStyle

Acryl Karaffe Colorstyle

Jarra ColorStyle

Acrilico / Acrilic

	Lt	Oz
<input type="checkbox"/> V60 12 08 002 13	1,5	50,7
<input type="checkbox"/> V60 12 08 002 47	1,5	50,7



Bicchieri frost

Glass frost
Gobelet frost
Glas Frost
Vaso frost

		Cl	Oz
V81 12 87 010	San	29	9,8
V81 12 87 001	San	40	13,5
V81 12 87 011	PP	29	9,8
V81 12 87 002	PP	40	13,5



Bicchieri trasparente

Glass transparent
Gobelet transparent
Durchsichtbares Glas
Vaso trasparente

		Cl	Oz
V81 12 87 012	San	29	9,8
V81 12 87 003	San	40	13,5
V81 12 87 015	PP	29	9,8
V81 12 87 006	PP	40	13,5



Bicchieri bianco

Glass white
Gobelet blanc
Weisses Glas
Vaso bianco

		Cl	Oz
V81 12 87 013	PP	29	9,8
V81 12 87 004	PP	40	13,5



Bicchieri nero

Glass black
Gobelet noir
Schwarzes Glas
Vaso negro

		Cl	Oz
V81 12 87 014	PP	29	9,8
V81 12 87 005	PP	40	13,5



Secchio spumante 1 bottiglia

Champagne bucket acrylic 1 bottle
 Seau à champagne 1 bouteille
 Champagneschale (Für 1 flasche)
 Cubo champán 1 botella

	Cm	H Cm	In	H In
V81 12 20 001 Plex -Transparent	22x16	23,5	8,5/8x6,1/4	9,1/4
V81 12 20 004 PS - Transparent	22x16	23,5	8,5/8x6,1/4	9,1/4
V81 12 20 007 PS Bianco - White	22x16	23,5	8,5/8x6,1/4	9,1/4

**Secchio spumante Magnum**

Magnum bucket
 Seau Magnum
 Champagneschale Magnum
 Cubo Magnum

	Cm	H Cm	In	H In
V81 12 20 002 Plex -Transparent	27,9x17,3	23,4	11x6,7/8	9,1/4
V81 12 20 005 PS - Transparent	27,9x17,3	23,4	11x6,7/8	9,1/4
V81 12 20 008 PS Bianco - White	27,9x17,3	23,4	11x6,7/8	9,1/4

**Secchio spumante Jeroboam**

Jeroboam bucket
 Seau Jeroboam
 Champagneschale Jeroboam
 Cubo Jeroboam

	Cm	H Cm	In	H In
V81 12 20 003 Plex -Transparent	48,2x20,9	24,3	19x8,1/4	9,5/8
V81 12 20 006 PS - Transparent	48,2x20,9	24,3	19x8,1/4	9,5/8
V81 12 20 009 PS Bianco - White	48,2x20,9	24,3	19x8,1/4	9,5/8



Runner - grigio scuro

Runner, dark grey
 Chemin de table gris foncé
 Runner dunkelgrau
 Camino de mesa gris oscuro

70% Pvc - 30% Pet

Cm
 AVARI TO 31 45x120

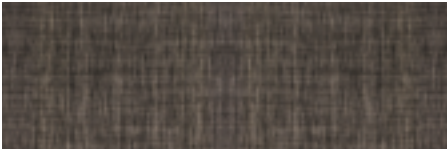
**Runner - grigio chiaro**

Runner, light grey
 Chemin de table gris clair
 Runner hellgrau
 Camino de mesa gris claro

70% Pvc - 30% Pet

Cm
 AVARI TO 30 45x120

**Runner - grigio tortora**

Runner, taupe
 Chemin de table taupe
 Runner taubegrau
 Camino de mesa gris topo

70% Pvc - 30% Pet

Cm
 AVARI TO 32 45x120

**Runner - grigio sabbia**

Runner, sand
 Chemin de table sable
 Runner sandgrau
 Camino de mesa arena

70% Pvc - 30% Pet

Cm
 AVARI TO 33 45x120

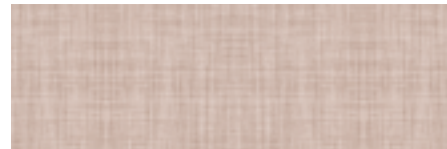
**Runner - grigio marrone con rettangolo**

Runner, brown with rectangle
 Chemin de table marron avec rectangle
 Runner braungrau rechteckig
 Camino de mesa marrón con rectángulo

70% Pvc - 30% Pet

Cm
 AVARI TO 34 45x120

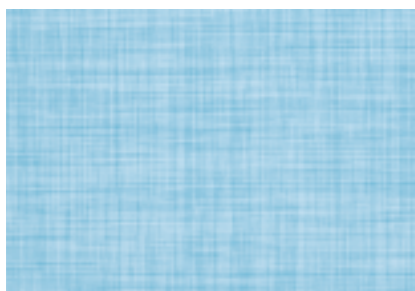

**Tovaglietta - azzurro**

Placemat - light blue
Nappe individuelle bleue
Klein Tischtuch hellblau
Mantel individual azul claro

Pvc-Pet

	Cm	In
AVARITO 06	45x30	17,3/4x11,3/4

**Tovaglietta - verde**

Placemat - green
Nappe individuelle verte
Klein Tischtuch grün
Mantel individual verde

Pvc-Pet

	Cm	In
AVARITO 09	45x30	17,3/4x11,3/4

**Tovaglietta - tortora**

Placemat - taupe
Nappe individuelle taupe
Klein Tischtuch grau
Mantel individual gris topo

Pvc-Pet

	Cm	In
AVARITO 03	45x30	17,3/4x11,3/4

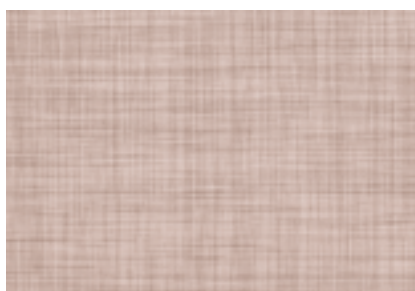
**Tovaglietta - sabbia**

Placemat - sand
Nappe individuelle sable
Klein Tischtuch sand
Mantel individual arena

Pvc-Pet

	Cm	In
AVARITO 07	45x30	17,3/4x11,3/4

**Tovaglietta - tortora quadrati**

Placemat - taupe, squares
Nappe individuelle taupe carrés
Klein Tischtuch grau mit quadraten
Mantel individual gris topo cuadrados

Pvc-Pet

	Cm	In
AVARITO 11	45x30	17,3/4x11,3/4

**Tovaglietta - marrone**

Placemat - brown
Nappe individuelle marron
Klein Tischtuch braun
Mantel individual marrón

Pvc-Pet

	Cm	In
AVARITO 10	45x30	17,3/4x11,3/4

**Tovaglietta - bianco**

Placemat - white
Nappe individuelle blanc
Klein Tischtuch weiss
Mantel individual blanco

Pvc-Pet

	Cm	In
AVARITO 13	45x30	17,3/4x11,3/4

**Tovaglietta - beige/azzurro**

Placemat - beige/blue
 Nappe individuelle beige/bleue
 Klein Tischtuch beige/hellblau
 Mantel individual beige/azul claro

Pvc-Pet

	Cm	In
AVARITO 05	45x30	17,3/4x11,3/4

**Tovaglietta - grigio scuro**

Placemat - dark grey
 Nappe individuelle gris fouché
 Klein Tischtuch dunkel grau
 Mantel individual gris oscuro

Pvc-Pet

	Cm	In
AVARITO 01	45x30	17,3/4x11,3/4

**Tovaglietta - marrone quadrati**

Placemat brown - squares
 Nappe individuelle marron carrés
 Klein Tischtuch braun mit quadrat
 Mantel individual marrón cuadrados

Pvc-Pet

	Cm	In
AVARITO 12	45x30	17,3/4x11,3/4

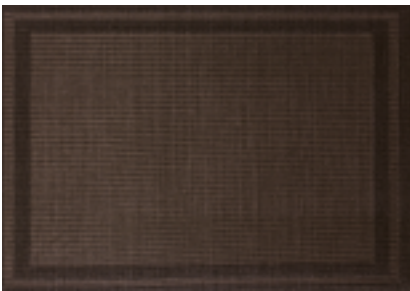
**Tovaglietta - marrone**

Placemat - brown
 Nappe individuelle marron
 Klein Tischtuch braun
 Mantel individual marrón

Pvc-Pet

	Cm	In
AVARITO 14	45x30	17,3/4x11,3/4

**Tovaglietta - grigio chiaro**

Placemat - light grey
 Nappe individuelle gris clair
 Klein Tischtuch hellgrau
 Mantel individual gris claro

Pvc-Pet

	Cm	In
AVARITO 02	45x30	17,3/4x11,3/4

**Tovaglietta - marrone lavorato**

Placemat - light brown - woven
 Nappe individuelle marron tressée
 Klein Tischtuch braun, gearbettes
 Mantel individual marrón tejido

Pvc-Pet

	Cm	In
AVARITO 08	45x30	17,3/4x11,3/4

**Tovaglietta - corallo**

Placemat - coral
 Nappe individuelle corail
 Klein tishtuch rot koralle
 Mantel individual coral

Pvc-Pet

	Cm	In
AVARITO 04	45x30	17,3/4x11,3/4



THE INTERNATIONAL CERTIFICATION NETWORK

CERTIFICATE

SQS and IQNet Partner hereby states that the organization

Abert S.p.A.

**Via Don P. Mazzolari, 17 (Zona Industriale)
25050 Passirano (BS)
Italia**

for the following scope and type of activities

Divisione Abert

Sito di Via Don P. Mazzolari, 17, 25050 Passirano (BS)

Progettazione, fabbricazione e commercializzazione di posate, complementi per la tavola, vasellame, caffettiere e pentolame.

has implemented and maintains a
Management System

which fulfills the requirements of the following standard(s)

ISO 9001:2015 / Quality Management System

for the validity date, please refer to the original certificate* issued by SQS

Scope No(s): 17

Issued on: 2016-11-11

Validity date: 2019-11-10

Registration Number: **CH-30537**



Michael Drechsel
Michael Drechsel
President of IQNet

Roland Glauser
Roland Glauser
CEO SQS



IQNet Partners**:
AENOR Spain AFNOR Certification France AIB Vinçotte International Belgium AFCEP Portugal CCC Cyprus
CISQ Italy CQC China CQM China COSC China CerteC Croatia DQS Holding GmbH Germany
PCAV Brazil FONDONORMA Venezuela ICONTEC Colombia IMC Mexico Inspecta Certification Finland INTECO Costa Rica
IRAM Argentina IQS-India KPI Korea MITEC Greece MIST Hungary Nemko AS Norway NSAI Ireland PCBC Poland
Quality Austria Astaris IP Russia SIGE Mexico SHI Israel SIQ Slovenia SIPIM QAS International Malaysia
SQS Switzerland SRIAC Romania TEST St Petersburg Russia TSE Turkey YUQS Serbia
IQNet is represented in the USA by: AFNOR Certification, CISQ, DQS Holding GmbH and NSAI Inc.

* This attestation is directly linked to the IQNet Partner's original certificate and shall not be used as a stand-alone document
** The list of IQNet partners is valid at the time of issue of this certificate. Updated information is available under www.iqnet-certification.com



Certificato

SQS attesta che l'azienda sotto indicata dispone di un sistema di management che soddisfa le esigenze della normativa indicata.



**Via Don P. Mazzolari, 17 (Zona Industriale)
25050 Passirano (BS)
Italia**

Campo d'applicazione

**Divisione Abert
Sito di Via Don P. Mazzolari, 17, 25050 Passirano (BS)**

Ambito d'attività

**Progettazione, fabbricazione e commercializzazione
di posate, complementi per la tavola, vasellame,
caffettiere e pentolame.**

Normativa base

ISO 9001:2015 Sistema di gestione per la qualità

Scope(s) 17

Validità 11.11.2016-10.11.2019
Versione 11.11.2016

No. di reg. 30537

X. Edelmann
X. Edelmann, Presidente SQS

R. Glauser
R. Glauser, CEO SQS



Associazione Svizzera per Sistemi
di Qualità e di Management SQS
Bernstrasse 103, 3052 Zollikofen, Svizzera



Partner of
IQNet

abert[®]

ABERT S.p.A.

Via Don P. Mazzolari, 17
25050 Passirano (Bs) Italy
T. 0306853611
F. 0306577194

info@abert.it
www.abert.it

abert[®]
CATALOGO HO.RE.CA. 2018