



2019 PRODUCT CATALOGUE





Mutfağın tüm renkleri...

All colours of the kitchen...

KAPP ÜRETİM TESİSLERİ MANUFACTURING FACILITIES



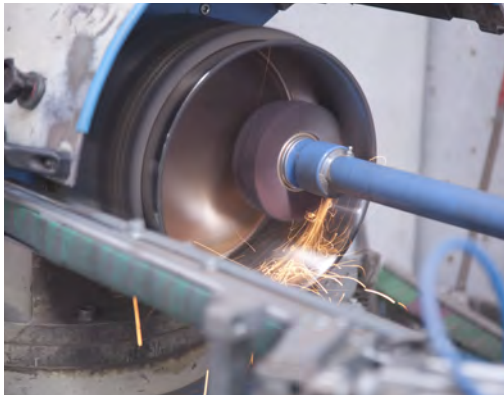



1

Pişirme

09/10	Düdüklü Tencere	20	Fırın Tepsileri	29	Döküm Tencereler
14	Silindirik Tencereler	22	İpinium Fırın Tepsileri	30/31	Döküm Tavalır
17	Exclusive	24	Paslanmaz Çelik Tavalır	33	Çelik Pişirme Örtüsü
19	Bistro	25	Kaçarola	34/35	Fırın Tepsileri
19	Siğ Tencere	26	Seramik Tavalır		
20	Bistro Kapaklar	27	Karbon Çelik Tavalır		
12	Exclusive Kapaklar	28/26	Sac Tavalır		



2

Hazırlık

38/39	Standart Gast. Küvetler	57	Çelik Kaplar	68	Tartılar
40/41	Süzgeçli Gast. Küvetler	58	Sebze Kurutucu	69	Ölçülü Kaplar
42/43	Saplı Gast. Küvetler	58	Japon Tornaları	70	Rendeler
44	Gastronom Kapaklar	58	Mandolin Kesme Ünit.	73/74	Süzgeçler
45/46	Gastronom Küvetler	59	Dilimleyiciler	75	Çırpma Telleri
47	Gastronom Ekipmanlar	60/61	Sebze Doğrayıcı	76	Spatulalar
49	Melamin Gast. Küvetler	62	Püre Makineleri	78	Polietilen Kesim Levhaları
52/53	PC Gastronom Küvetler	62	Konserve Açacağı	84/88	Bıçaklar
55	PC Ölçülü Saklama Kap.	63/65	El Aletleri	89	Çelik Eldiven
56	PP Saklama Kapları	66/67	Termometreler	89	Bıçak Sterilizatörü



3

Pastacılık

92/94	Yapışmaz Kalıplar	107	Eldiven
95/100	Silikon Kalıplar	108	Ekipmanlar
101/102	Çikolata Kalıpları	110	Termometre
103	Çikolata Ekipmanları	111	Ölçme Kapları
104	Dilimleme Makinesi	112	Standlar
105/107	Paslanmaz Çelik Kalıp	114/115	Spatulalar



4

Servis

118	PC Kırılmaz Tepsi	124	Servis Set (İthal)	128	Keççe Standı
118/119	Tepsiler	125	Silikon Servis	128	Patates Küreği
121	Keççeler	126/127	Maşalar	129	Sos Dispenserleri
121	Kevgirler	127	Şef Cimbızı	129	Sos Şişeleri
123	Kaşıklar	128	Dekor Kaşık Seti	129	Sos/Şurup Dökücü
123	Et Çatalları	128	Dondurma Kaşıkları		
123	Spatulalar	128	Kaşık Standı		



5

Açık Büfe

133	Bakır Chafing Dish	157	Dispenser
135/139	Vega Chafing Dish	154	Standlar
141/145	Carina Chafing Dish	159/161	Delux Chafing Dish
147	Carina Serisi	162	Classic Chafing Dish
149/151	Lux Chafing Dish	163	Chafing Dish Küvetler
151	Lux Dispenser	185	Ekipmanlar
152/153	Fusion Chafing Dish	187	Dispenserler
153	Fusion Dispenser	191	Isıtıcı Lambalar
155/157	Premium Chafing Dish		



6

Restaurant

192/193	Kayrak Sunumluk	203	Kaseler
193/194	Ahşap Sunumluk	208	Ekmek Sepetleri
195	Tabaklar PC	209	Küllükler
196/199	Tuzluk & Karabiberlik		
200	Yağlık & Sirkelik		
202	Sunum Tabacağı		



7

İçecek

210	Serbetlik	212	İçecek Makineleri
210	Sıcak Çikolata	218	İçecek Mikseri
211	Dondurma Makinesi	218	Buz Makineleri
211	Buzlu İçecek Makinesi/Ice Slush	219	Termos
212	Blender	220	Sürahi
211	Çay Otomatları	222	French Press
		223	PC Bardaklar



8

Bar

224	Buz Kovaları	227	Masa Standı	231	Bar Ekipmanları
225	Şişe Soğutucular	229	Punch Bowllar	232	Çerezlikler
225	Şampanya & Şarap Kovaları	230	Kokteyl Shakerlar	232	Tepsiler
226	Şampanya Kova Standı	230	Garson Çakısı	233	Küllükler
226	Şişe Standı	230	Tirbüşon		



9

Ekipmanlar

234/235	El Tipi Blender	254	Soft Cooker
236/240	Sebze Doğrayıcılar	256	Mikrodalga Fırın
241	Peynir Rendeleyici	257	Konveyörlü Fırın
242/247	Gıda Dilimleyiciler	258	Ekmek Kızartma Mak.
248/249	Planet Mikser	259	Kıyma Makinesi
250/251	Et-Kemik Testeresi	272	İndüksiyon Ocaklar
252	Vakumlu Paket	273	Buz Makineleri



10

Taşıma

274	Taşıma Kovaları	278	Servis Arabaları	280	Taşıma Arabaları
275	Sefer Tasları	279	Tabak İstif Arabaları	281	SDX Boxlar
275	Taşıma Tepsileri	279	Kaset Taşıma Arabası	285/287	Tel Raflar
276/277	Thermoboxlar	279	Et Arabası		



11

Bulaşık

290	Basketler	293	Bulaşık Yıkama Duşları
290	Yükselticiler	293	Evyeler
290	Çatal Kaşık Basketi	293	Çöp Kovası
291	Basket Taşıma Arabası	293	Saksılık
292	Elektrikli Sinek Öldürücü		



1

Cooking

09	Pressure Cooker	20	Lids (Exclusive Line)	28	Pans Carbon Steel
09	Pressure Cooker Lid	20	Colander (Exclusive Line)	28/31	Pots&Pans Cast Iron
09	Silicone Seal	20	Pasta Colander Set	33	Roast Easy
14	Stock Pots	20	Couscous Set	34	Roasting Pans
17	Stock Pots(Exclusive Line)	21	Wide Shallow Pots	35	Roasting Pan Ipinium
19	Stock Pots(Bistro Line)	21	Wide Shallow Pan		
20	Casseroles(Bistro Line)	23/25	Pans Stainless Steel		
20	Shallow Stew Pan(Bistro Line)	25	Fry Pan(Bistro Line)		
20	Sauce Pan(Bistro Line)	26	Pans Aluminium Non Stick		
20	Lids (Bistro Line)	27	Pans Carbon Steel		



2

Preparing

38/39	GN Food Pans	58	Salad Spinner	70	Grater
40/41	GN Food Pans Perforated	58	Slicers	72	Calibrated Bowls
42/43	GN Food Pans w/handle	58	Mandolines	73	Colander
44	Gn Food Pan Lid	59	Food Mill	74	Strainers/Skimmer
45	Gn Appetizer Pan	59	Hamburger Press	75	Whisk
49	Gn Melamine Pans	60	Scissor	76	Spatulas
50/53	PC GN Pans	60/65	Utensils	78/79	PE Cutting Board For Gn Pan
55	Pc Square Food Storage Cont.	66	Thermometer	80/88	Knives
56	Pp Storage Containers	66	Timer Digital	89	Knife Sterilizer
57	Abc Containers	67	Scale	89	Butcher Gloves Chainmail



3

Pastry

92/94	Mould Non-stick	109	Square Ring	113	Rolling Pin
95/100	Moulds Silicone	109	Dough Wheel	113	Bo
100	Baking Sheet Non-stick	110	Glove	114	Flacone
100	Toastbrot Non-stick	110	Pastry Bag	114	Pouring Container
104	Baking Sheet Silicone	110	Cream Whipper	115	Cake Stand
101/102	Chocolate Moulds	111	Icing Tip Set	115	Revolving Cake Stand
105	Adjustable Mould	112	Torch	115	Tray Aluminium
105/106	Cake Ring	113	Roller		



4

Serving

118	Tray PC Unbreakable	123	Serving Spatulas	126	Ice Cream Spoon
119/120	Tray Display	123	Serving Set	126	Spoon Rest
121	Self Service	123	Silicone Utensils	126	Deco Spoon Set
122	Ladles	123	Tongs	127	Sauce Bottles
122	Skimmers	124	Charcoal Tong	128/132	Pouring Container
122	Serving Spoons	125	Grill Tong	129	Sauce Dispensers
122	Meat Forks	126	Chef Tong		



5

Open Buffet

133	Chafing Dish Copper	162/164	Sauce Tureen	183	Amuse Bouche Spoon
136/139	Chafing Dish Vega	165/166	Soup Tureen	185	Amuse Bouche Spoon St.
146/147	Chafing Dish Carina	168/169	Chafing Dish Equipment	188/189	Mini Melamine Displays
149/154	Chafing Dish Lux	172/173	Dispensers	190/191	Tray Crystal Display
156/159	Chafing Dish Modern	174/175	Infrared Lamp	192/193	Elevator
159	Chafing Dish Premium	176/179	Display Stand	194/196	Slate Display
160/161	Chafing Dish Delux	180/182	Open Buffet Units	197/198	Bowl
161	Chafing Dish Built-in	182	Induction Cooker	201	Baguette Basket
161	Chafing Dish Classic	182	Stand	201	Bread Basket Rattan



6

Table-Top

204/205	Slate Display Plates	211/212	Table-Top Items
206/207	Wooden Display Plates	213	Bowls
208	Plates PC	214	Bread Basket
209	Salt & Pepper Set	215	Ashtray
210	Condiment Set	215	Ashtray Stand
210	Jar Set		



7

Beverage

218	Juice Cooler	221	Tea Maker	223	Acrylic Sugar Caddy
219	Cooler&dispenser	221	Blender	223	Mug
219	Hot Chocolate Dispenser	221	Citrus Juicer	223	Tea/milk Pot
220	Granita&ice Slush Dispenser	221	Dispenser	223	Water Jug
220	Ice Slush Dispenser	222	French Press	223	Jug PC
221	Orange Juicer	222	Glass Mug	223	Glass Pc
221	Pomegranate Dispenser	222	Mini Tea Bag Holder		



8

Bar

224	Bottle Cooler	227	Boston Shaker	230	Chalice Sweetener
224	Ice Bucket	227	Cocktail Shaker	230	Jigger
224	Mini Punch Bowl	227	Mixing Glass	231	Napkin/pipette Holder
224	Champagne Bucket	228	Punch Bowl	232	Pc Bar Container
225	Wine Bucket	228	Ice Crusher	232	Pourer
225	Bottle Stand	229	Bar Spoon	233	Appetizer Display
226	Champagne Bucket Stand	229	Bar Strainer	233	Ashtrays
226	Wine Bucket Table Stand				



9

Kitchen Appliances

237	Blender	258	Soft Cooker	271	Beverage Blender
243	Vegetable Cutter	259	Microwave Oven	270	Beverage Mixer
244/248	Cheese Grater	260	Convection Oven	272	Citrus Juicer
249	Slicer	262	Meat Grinder	273	Ice Crushing Machine
250/255	Planet Mixer	263	Conveyor Toaster		
256	Bone Saw	264	Induction Cooker		
257	Vacuum Packaging	265	Pizza Warmer		



10

Carrying

274	Carrying Container	277	Serving Trolley	282	Adjustable Dish Dolly
275	Carrying Tray	278	Waste Bin	283	Plate Rack Mobile
275	Portable Food Container	279	Cutlery Bin	283	Meat Carrying Dolly
276	Thermobox 600	279	Cutlery Bin 4 Compartment	284	Utility Rack
276	Beverage Thermobox	279	Demontable Service Trolley	284	Sdx Thermobox
276	Isothermic Tray	280	Monoblock Service Trolley	285	Perforated Shelf
276	Thermobox	281	Ingredient Bin	285/287	Perforated Shelf W/4 Floor



11

Dish Washing

290	Compartment Base	293	Dolly
290	Cutlery Rack	293	Insect Killers Electrical
290	Glass Rack	293	Dish Washing
291	Plate/trays Rack	293	Rubbish Bin
292	Compartment Extender	293	Sink





Piřirme

Cooking

- 1,20 mm kalınlığında 304 kalite paslanmaz çelikten imal edilmiştir
- 3 adet emniyet valfi mevcuttur; 1. valf açılmadığı takdirde 2.valf, 2. valf de açılmaz ise 3. valf devreye girer
- Buhar boşaltma valfi 3 konumdan oluşur: 1. ve 2. konum pişirmede, 3. konum buhar boşaltmada kullanılır
- Kapak parçaları sökülüp takılabilir ve yıkanabilir
- Indüksiyon ocaklara uygundur

- 3 Independent Safety Valves for Security
- Blowoff valve consists of 3 positions: 1. and 2. position is for cooking, 3. position is for blowoff
- Innovative Lid with Easy to Use Locking System
- Impact Bonded Sandwich Bottom
- Fast and Efficient Heat Distribution
- Heat Resistant Side Handles
- 18/10 Stainless Steel, 1,20 mm thickness
- Easy Cleaning With Removable Lid Attachments



» Düdüklü Tencere / Pressure Cooker

Kod Code	Øxh (cm) Øxh (cm)	Lt Lt
32384025	40x25	32
32384030	40x30	37
32384040	40x40	50

Kod Code	Model Model	Ø (cm) Ø (cm)
35700040	Düdüklü Tencere Kapak / Pressure Cooker Lid	40
35700155	Silikon Kapak Contası / Silicone Seal	40





10

» Düdüklü Tencere / Pressure Cooker

Kod Code	Øxh (cm) Øxh (cm)	Lt Lt
32383219	32x19	15
32383223	32x23	18
32383230	32x30	23

Kod Code	Øxh (cm) Øxh (cm)	Ø (cm) Ø (cm)
35700032	Düdüklü Tencere Kapak / Pressure Cooker Lid	32
35700154	Silikon Kapak Contası / Silicone Seal	32



- 1,20 mm kalınlığında 304 kalite paslanmaz elikten imal edilmiřtir
- 2 adet emniyet valfi mevcuttur; 1. valf aılmadıđı takdirde, 2. valf devreye girer
- Buhar bořaltma valfi 3 konumdan oluřur: 1. ve 2. konum piřirmede, 3. konum buhar bořaltmada kullanılır
- Kapak paraları soklp takılabilir ve yıkanabilir
- İndüksiyon ocaklara uygundur

- 2 Independent Safety Valves for Security
- Blowoff valve consists of 3 positions: 1. and 2. position is for cooking, 3. position is for blowoff
- Innovative Lid with Easy to Use Locking System
- Impact Bonded Sandwich Bottom
- Fast and Efficient Heat Distribution
- Heat Resistant Side Handles
- 18/10 Stainless Steel, 1,20 mm thickness
- Easy Cleaning With Removable Lid Attachments



TRADITION OF TECHNOLOGY AND QUALITY

TECHNICAL SPECIFICATIONS

Made of high-quality, robust 18/10 stainless steel pots and pans are designed for long run in hard conditions of Professional Kitchens.

Three layers base of each product is compressed with the IMPACT BONDING* method at a high pressure which results with the non separable layers and even heat distribution.

Handles are tack welded up to 10 points for the strongest holding.

Easy to grasp stainless steel stay-cool handles

Extra helper handling at sizes over Q 32,a special design for Professional use only.

Suitable to all kind of stove tops including induction*

Dishwasher safe

- KAPP stands out with "IMPACT BONDED" three layer sandwich bottom in all lines and sizes.
- KAPP is the only brand which offers "induction ready"cookware in ALL sizes.

DESIGN

-Perfect balance and ergonomy

-Pure sophistication

-Perfectionist approach in every single detail

QUALITY

KAPP products are extremely robust.Tried and tested up to the highest standards.By leveraging our strengths in product design,packaging and distribution;we provide unique,innovative solutions for Professional Kitchens

KAPP products are manufactured by means of attentive production processes and only delivered after strict quality controls.

All the procedures are monitored by our Quality Management System which is certified by TUV, GOST, HACCP and CE internationally.

"The Great Lake Culinary Institute Laboratories" in USA ,tested and approved our quality and classified KAPP products within the best quality product ranges in the world.



TEKNOLOJİ VE KALİTE GELENEĞİ

25 yıllık tecrübe, en son teknolojiyle birleştirilmiştir. **KAPP**' in 18/10 kalite paslanmaz çelik tencere ve tavaları profesyonel aşçıların kullanımı için tasarlanmıştır.

3 kat taban "impact" metodu ile 2500 tonluk preslerde çakılmaktadır.

Bu üretim tekniğinde tencerenin pişirme özelliklerinin en iyi sonucu verdiği Bağımsız Ulusal Test sonuçlarıyla belgelendirilmiştir.



Paslanmaz Çelik
/Stainless Steel
Alüminyum
/Aluminum
Paslanmaz Çelik
/Stainless Steel

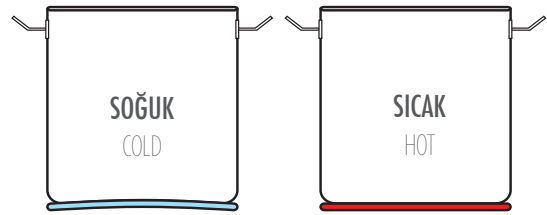

13

ÇAKMA TABAN / IMPACT BOUNDING

YAPIŞTIRMA TABAN / BRAZED BOTTOM

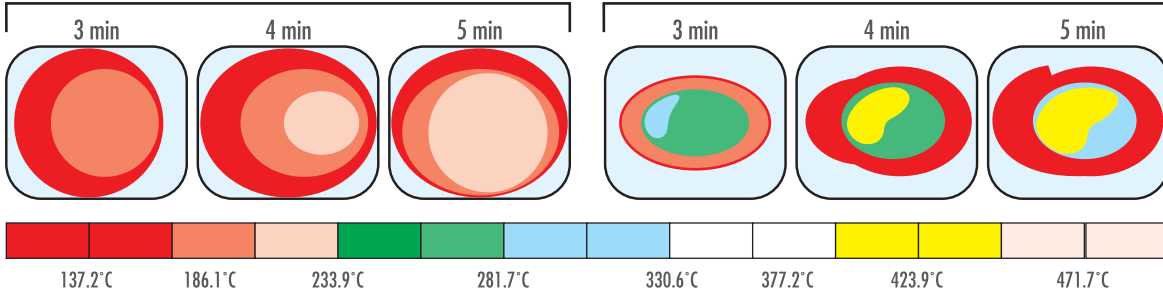

* Tencere tabanı 2500 ton üzerinde

Kuvvetle çakılmaktadır.

/ Bases are forged bound by over 2500 tons pressure

* %95 oranında saf alüminyum

/ %95 pure aluminum

* Taban saclarında %99 üzerinde birleşme

/ Bottom plates combine chemically over %99

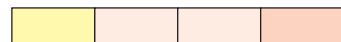

Mükemmel eşit pişirme

/ Perfect even cooking

Yapışma, yanma ihtimali

Değişken ısı

/ Sticking, burning possibility

Variable heat

Yapışma, yanma

Yüksek ısı

/ Sticking, burning

High heat

* Yapışma makinesiyle birleştirme

/ Combine with brazing machine

*Normal, saf olmayan alüminyum

/ Standart aluminum, not pure

*3. Katın %55 oranında birleşmesi

/ %55 combining of the 3. Layer

Silindirik Tencereler / Stock Pots Casserols



Derin (Kapaklı) / Deep (w/lid)

Kod Code	Øxh (cm) Øxh (cm)	Lt Lt
30141616	16x16	3,0
30141818	18x18	4,5
30142020	20x20	6,3
30142424	24x24	10,5
30142828	28x28	17,2
30143231	32x32	26,0
30143635	36x36	36,6
30144040	40x40	50,0
30144544	45x45	70,0
30145050	50x50	100
30146055	60x55	155,4

Orta Derin (Kapaklı) / Medium Deep (w/Lid)

Kod Code	Øxh (cm) Øxh (cm)	Lt Lt
30141611	16x11	2,0
30141812	18x12	3,0
30142017	20x17	5,3
30142419	24x19,5	8,8
30142823	28x23	14,2
30143227	32x27,5	22,1
30143629	36x29	29,5
30144025	40x25	32,0
30244528	45x28	44,0
30145030	50x30	58,0
30146035	60x35	99,0

Orta Sığ (Kapaklı) / Medium Shallow (w/Lid)

Kod Code	Øxh (cm) Øxh (cm)	Lt Lt
30141608	16x7	1,4
30141809	18x8	2,0
30142010	20x9	3,0
30142013	20x13	4,1
30142411	24x10,5	5,0
30142415	24x15	6,8
30142817	28x17	10,5
30143215	32x15	12,1
30143219	32x19	15,3
30143617	36x17	17,3
30143622	36x22	22,4
30144019	40x19	25,0
30144522	45x22	35,0
30145020	50x20	39,0
30145025	50x25	48,0
30146025	60x25	70,0

14



Sığ Tencere (Kapaklı)

Shallow Stew (w/lid)

Kod Code	Øxh (cm) Øxh (cm)	Lt Lt
30142005	20x5	1,8
30142405	24x5	2,1
30142475	24x7,5	3,5
30142807	28x7	4,3
30143275	32x7,5	6,0
30143608	36x8	8,1
30144008	40x8	10,0
30144510	45x10	15,9
30145010	50x10	20,0
30146010	60x10	28,3

Çorbalık (Gömme)

Soup Pot (Built-in)

Kod Code	Øxh (cm) Øxh (cm)	Lt Lt
35522428	24x28 (Tabanlı/w/base)	12,5
35522828	28x28 (Tabanlı/w/base)	17,2
35523232	32x32 (Tabanlı/w/base)	26,0
35503637	36x36 (Tabanlı/w/base)	36,6
35504050	40x40 (Tabanlı/w/base)	50,0
35505051	50x50 (Tabanlı/w/base)	100
35506055	60x55 (Tabanlı/w/base)	155
35522400	24x28 (Tabansız/w/o base)	12,5
35522800	28x28 (Tabansız/w/o base)	17,2
35523200	32x32 (Tabansız/w/o base)	26,0
35503600	36x36 (Tabansız/w/o base)	36,6
35504000	40x40 (Tabansız/w/o base)	50,0
35505000	50x50 (Tabansız/w/o base)	100
35506000	60x55 (Tabansız/w/o base)	155





Exclusive

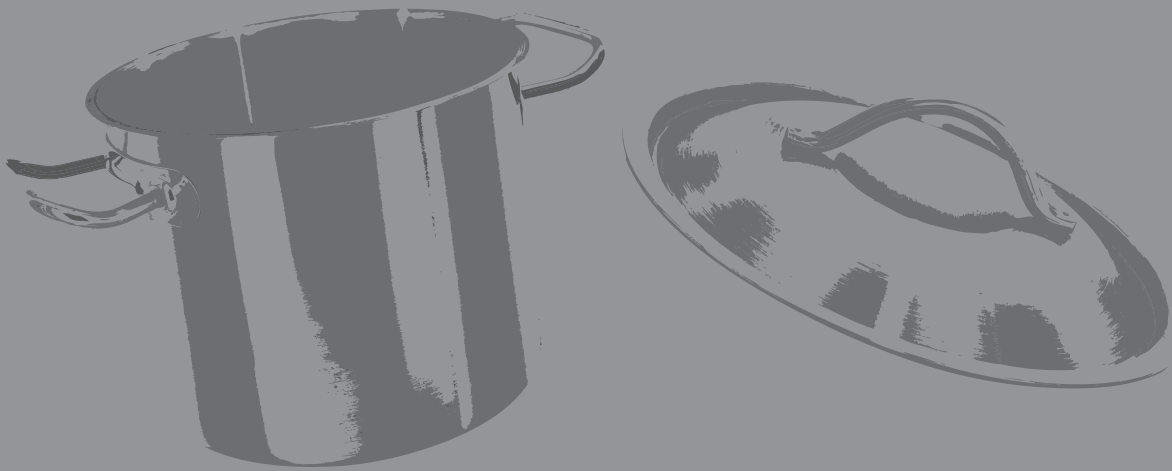

Exclusive Serisi

- Thick AISI 304 stainless steel body designed for professional use
- Usable at all hobs
- Aliminum sandwich base for perfect heat diffusion
- Sandwich base produced with impact bonding technique for heavy duty use and even cooking
- Special welded stainless steel handles for heavy duty use
- Heat resistant handles
- HACCP certified qualifies w hygiene standards

Exclusive Line

- Thick AISI 304 stainless steel body designed for professional use
- Usable at all hobs
- Aliminum sandwich base for perfect heat diffusion
- Sandwich base produced with impact bonding technique for heavy duty use and even cooking
- Special welded stainless steel handles for heavy duty use
- Heat resistant handles
- HACCP certified qualifies w hygiene standards



» Derin Tencere
Jumbo Stock Pot

Kod Code	Øxh (cm) Øxh (cm)	Lt Lt
30311616	16x16	3,0
30312020	20x20	6,3
30312424	24x24	10,5
30312828	28x28	17,2
30313030	30x30	21,2
30313231	32x32	26,0
30313635	36x36	36,6
30314038	40x40	50,0
30314544	45x45	70,0
30315050	50x50	100,0
30316055	60x55	155,4



» Orta Derin Tencere
Stock Pot

Kod Code	Øxh (cm) Øxh (cm)	Lt Lt
30311615	16x14,5	2,9
30312017	20x17	5,3
30312419	24x19,5	8,8
30312823	28x23	14,2
30313024	30x24	17,0
30313228	32x27,5	22,1
30313629	36x29	29,5
30314032	40x32	40,0
30314528	45x28	44,0
30315030	50x30	58,0
30316035	60x35	99,0



» Orta Boy Tencere
Deep Casseroles

Kod Code	Øxh (cm) Øxh (cm)	Lt Lt
30311611	16x11	2,0
30311812	18x12	3,0
30312013	20x13	4,1
30312214	22x14	5,0
30312415	24x15	7,0
30312817	28x17	11,0
30313020	30x20	14,1
30313219	32x19	15,0
30313622	36x22	23,0
30314025	40x25	32,0
30314522	45x22	35,0
30316025	60x25	70,0



» Orta Sığ Tencere
Shallow Casseroles

Kod Code	Øxh (cm) Øxh (cm)	Lt Lt
30311607	16x7	1,4
30311808	18x8	2,0
30312009	20x9	3,0
30312210	22x9,5	3,6
30312411	24x10,5	4,7
30312613	26x13	6,5
30312812	28x12	7,4
30313015	30x12	10,6
30313215	32x15	12,1
30313617	36x17	17,3
30314019	40x19	25,0
30315019	50x20	39,3



» Sığ Tencere
Shallow Stew Pan

Kod Code	Øxh (cm) Øxh (cm)	Lt Lt
30312807	28x7	4,3
30313208	32x7,5	6,0
30313608	36x8	8,1
30314008	40x8	10,0
30314510	45x10	15,9
30315010	50x10	20,0
30316010	60x10	28,3



Bistro

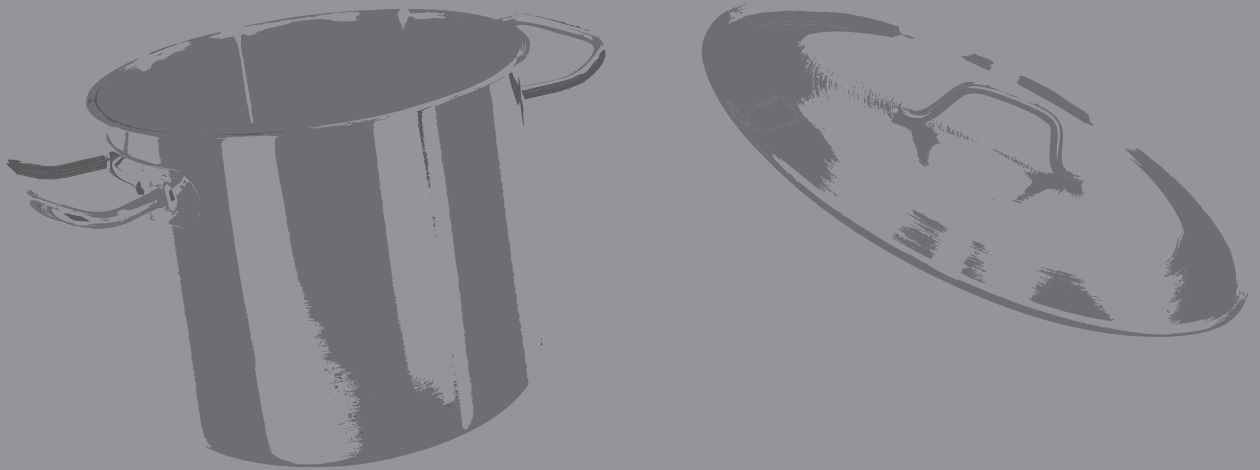

Bistro Serisi

- S/S body designed for professional use usable at all hobs
- Limited size range
- Aliminum sandwich base for perfect heat diffusion
- Sandwich base produced with impact bonding technique for heavy duty use and even cooking
- Special welded stainless steel handles for heavy duty use
- Heat resistant handles
- HACCP certified qualifies w hygiene standards

Bistro Line

- S/S body designed for professional use usable at all hobs
- Limited size range
- Aliminum sandwich base for perfect heat diffusion
- Sandwich base produced with impact bonding technique for heavy duty use and even cooking
- Special welded stainless steel handles for heavy duty use
- Heat resistant handles
- HACCP certified qualifies w hygiene standards



» Derin Silindirik Tencere
Jumbo Stock Pot

Kod Code	Øxh (cm) Øxh (cm)	Lt Lt
30151616	16x16	3,0
30152020	20x20	6,0
30152424	24x24	10,5
30152828	28x28	17,2
30153232	32x32	25,7



» Orta Derin Silindirik Tencere
Stock Pot

Kod Code	Øxh (cm) Øxh (cm)	Lt Lt
30151615	16x14,5	2,9
30152017	20x17	5,3
30152419	24x19,5	8,8
30152823	28x23	14,2
30153228	32x27,5	22,1
30153629	36x29	29,5
30154528	45x28	44,0
30155030	50x30	58,0



» Orta Sığ Silindirik Tencere
Deep Casseroles

Kod Code	Øxh (cm) Øxh (cm)	Lt Lt
30151611	16x11	2,0
30151812	18x12	3,0
30152013	20x13	4,1
30152415	24x15	7,0
30152817	28x17	11,0
30153219	32x19	15,0
30153622	36x22	23,0
30154025	40x25	32,0
30154522	45x22	35,0



» Sığ Tencere
Shallow Casseroles

Kod Code	Øxh (cm) Øxh (cm)	Lt Lt
30151607	16x7	1,4
30151808	18x8	2,0
30152009	20x9	3,0
30152411	24x10,5	5,0
30152812	28x12	7,4
30153215	32x15	12,1
30153617	36x17	17,3
30154019	40x19	25,0
30155020	50x20	39,3



» Sığ Tencere
Shallow Stew Pan

Kod Code	Øxh (cm) Øxh (cm)	Lt Lt
30152807	28x7	4,3
30153208	32x7,5	6,0
30153608	36x8	8,1
30154008	40x8	10,0

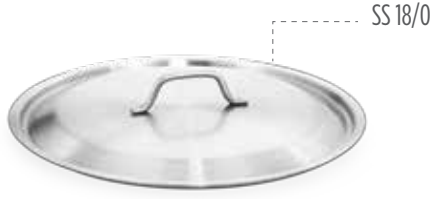

» Bistro Kapaklar

Bistro Lids

Kod Code	Ø (cm) Ø (cm)
30110016	16
30110018	18
30110020	20
30110024	24
30110028	28
30110032	32
30110036	36
30110040	40
30110045	45
30110050	50

» Exclusive Kapaklar

Exclusive Lids

Kod Code	Ø (cm) Ø (cm)
30210112	12
30210114	14
30210116	16
30210118	18
30210120	20
30210122	22
30210124	24
30210126	26
30210128	28
30210130	30
30210132	32
30210136	36
30210140	40
30210145	45
30210150	50
30210160	60

20



» Makarna Pişirme Süzgeci Seti

Pasta Colander Set

Kod Code	Øxh (cm) Øxh (cm)	Lt Lt
36312420	24x19,5 (3 Süzgeçli/ 3 Colanders)	8,0
36313623	36x22 (4 Süzgeçli/4 Colanders)	22,4
36314026	40x25 (4 Süzgeçli/4 Colanders)	32,0

* Fiyatlara kapak dahildir. / Lid is included in price

» Makarna Pişirme Süzgeci

Pasta Colander

Kod Code	Özellik Description
36302420	24x19,5 Tencere ile uyumludur / Suitable for 24x19,5 Pot
36303623	36x22 Tencere ile uyumludur / Suitable for 36x22 Pot
36304026	40x25 Tencere ile uyumludur / Suitable for 40x25 Pot





» Kuskus Tencere Seti (Kapaklı)
Couscous Set (w/lid)

Kod Code	Øxh (cm) Øxh (cm)	Lt Lt
35614032	A 40x24 B 32x32	30
35615040	A 50x24 B 40x40	47
35616040	A 60x24 B 40x40	65
35616045	A 60x24 B 45x45	65
35616050	A 60x24 B 50x50	65



» Kuskus Tencere Süzgeci
Couscous Colander

Kod Code	Øxh (cm) Øxh (cm)
35664032	40x24
35665040	50x24
35666045	60x24



» Tencereler (Kapaklı)

Wide Shallow Pots

Kod Code	Øxh (cm) Øxh (cm)	Lt Lt
30013015	30x15	13
30013615	36x15	16
30013620	36x20	21
30014017	40x17	24
30014520	45x20	29
30015020	50x20	36
30015520	55x20	40
30016020	60x20	45
30016025	60x25	65
30016525	65x25	75
30017030	70x30	108
30018030	80x30	136
30019030	90x30	166
30010035	100x35	258
30011035	110x35	289



» Helvane Kapaklar

Lid

Kod Code	Ø (cm) Ø (cm)
30210300	30
30210360	36
30210400	40
30210450	45
30210500	50
30210550	55
30210600	60
30210650	65
30210700	70
30210800	80
30210900	90
30210100	100
30210110	110



Paslanmaz Çelik Tavalar

- Paslanmaz çelik gövde
- Profesyonel kullanıma uygun ısıya dayanıklı paslanmaz çelik saplar
- Impact teknolojisi ile imal edilmiş 3 kat sandviç taban
- Her kullanıma uygun ölçü seçenekleri
- Mükemmel ısı dağılımı
- Saten yüzey
- İndüksiyon ocaklara uygundur

Stainless Steel Pans

- Stainless Steel 18/10 body
- Heat Resistant Stainless Steel Professional Handles
- Impact bonded sandwich bottom
- Multiple size options for various cooking
- Even Heat Distribution
- Satin Finishing





» Exclusive Tek Saplı Tava
Exclusive Fry pan

Kod Code	Øxh (cm) Øxh (cm)	Lt Lt
30412004	20x5	1,6
30412405	24x5,5	2,5
30412806	28x6	3,7
30413207	32x7	6,0
30413608	36x7	8,1
30414008	40x8	10,1

* Ø32, Ø36, Ø40 Destek sap ilavedir
* Ø32, Ø36, Ø40 w/helper handle



» Bistro Tek Saplı Tava
Bistro Fry pan

Kod Code	Øxh (cm) Øxh (cm)	Lt Lt
30152004	20x5	1,6
30152405	24x5,5	2,5
30152806	28x6	3,7
30153206	32x7	6,0
30153606	36x7	8,1
30154007	40x8	10,1

* Ø32, Ø36, Ø40 Destek sap ilavedir
* Ø32, Ø36, Ø40 w/helper handle



» Exclusive Tek Saplı Yapışmaz Çelik Tava
Exclusive Non-Stick Coated Fry Pan

Kod Code	Øxh (cm) Øxh (cm)	Lt Lt
30342004	20x5	1,6
30342405	24x5,5	2,5
30342805	28x6	3,7
30343207	32x7	6,0
30343608	36x7	8,1
30344008	40x8	10,1

* Ø32, Ø36, Ø40 Destek sap ilavedir
* Ø32, Ø36, Ø40 w/helper handle

* İndüksiyon ocaklarda kullanılmaz.
* Not suitable for induction



» Çift Saplı Tava (Paella)
Paella Pan

Kod Code	Øxh (cm) Øxh (cm)	Lt Lt
30362004	20x5	1,6
30362405	24x5,5	2,5
30362806	28x6	3,7
30363207	32x6,5	6,0
30363608	36x7,5	8,1
30364008	40x8	10,1



» Sahanlar
French Omelette Pan

Kod Code	Øxh (cm) Øxh (cm)
30315014	14x3
30315016	16x3
30315018	18x3
30315020	20x3
30315022	22x3
30315024	24x3
30315028	28x3
30315032	32x3



» Helvane Tava
Wide Shallow Pan w/o Lid

Kod Code	Øxh (cm) Øxh (cm)	Lt Lt
30323008	30x8	5,0
30323609	36x9	9,0
30323812	38x12	13,5
30324012	40x12	15,7
30324512	45x12	19,0
30325012	50x12	23,0
30326014	60x14	34,0
30327015	70x14	53,5
30328016	80x16	73,0





» Derin Tava (Balık Tava)

Saute Pan

Kod Code	Øxh (cm) Øxh (cm)	Lt Lt
30452004	20x5	1,6
30452405	24x5,5	2,5
30452805	28x8	3,7
30453207	32x7,5	6,0
30453606	36x8	8,1



» Yapışmaz Sote Tava

Non-stick Coated Conical Saute Pan

Kod Code	Øxh (cm) Øxh (cm)	Lt Lt
30331605	16x6	0,75
30331805	18x6,5	1,0
30332005	20x7	1,9
30332405	24x8	2,5

24



» Sote Tava

Conical Saute Pan

Kod Code	Øxh (cm) Øxh (cm)	Lt Lt
30431606	16x6	0,75
30431806	18x6,5	1,0
30432006	20x7	1,9
30432406	24x8	2,5

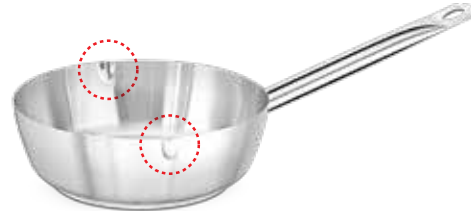

» Sote Tava (Çift Dökme Ağızlı)

Conical Saute Pan w/Double Spouts

Kod Code	Øxh (cm) Øxh (cm)	Lt Lt
30351606	16x6	0,75
30351806	18x6,5	1,0
30352007	20x7	1,9
30352408	24x8	2,5



CERAMIC

ELECTRIC

INDUCTION

GAS

DISHWASHER



» Exclusive Derin Sos Tenceresi
Exclusive Deep Sauce Pan

Kod Code	Øxh (cm) Øxh (cm)	Lt Lt
30380008	16x11	2,2
30380004	18x12	3,1
30380005	20x13	4,1
30380019	22x14	5,3
30380006	24x15	6,8
30380020	28x17	10,5
30380021	30x12	8,5
30380030	32x15	12,1

*Ø28, Ø30, Ø32 Destek sap ilavedir

*Ø28, Ø30, Ø32 w/helper Handle



» Exclusive Şığ Sos Tenceresi
Exclusive Shallow Sauce Pan

Kod Code	Øxh (cm) Øxh (cm)	Lt Lt
30380007	12x6	0,7
30380010	14x7	1,1
30380015	16x7	1,4
30380018	18x8	2,0
30380017	20x9	2,8
30380016	22x9,5	3,6
30380014	24x10,5	4,7
30380027	26x13	6,5



» Bistro Kaçarola
Bistro Sauce Pan

Kod Code	Øxh (cm) Øxh (cm)	Lt Lt
30150007	12x6	0,7
30150010	14x7	1,1
30150015	16x8	1,4
30150008	16x11	2,0
30150018	18x9	2,2
30150004	18x12	3,1
30150017	20x10	3,2
30150005	20x13	4,0
30150014	24x10,5	5,0
30150006	24x15	7,0
30150022	28x14	7,6
30150020	28x17	11,0
30150030	32x15	12,1
30150015	16x7	1,4
30150018	18x8	2,0
30150017	20x9	3,0
30150014	24x10,5	5,0



» Tabansız Kaçarola
Sauce Pan without Sandwich Bottom

Kod Code	Øxh (cm) Øxh (cm)	Lt Lt
30381206	12x6	0,7
30381407	14x7	1,1
30381607	16x8	1,4
30381611	16x11	2,2
30381809	18x9	2,0
30381812	18x12	3,1
30382010	20x10	3,2
30382013	20x13	4,1
30382411	24x10,5	5,0
30382415	24x15	6,8
30382814	28x14	7,6

* Pişirme amaçlı kullanılmaz.

* Not suitable for cooking



Alüminyum Yapışmaz Tavalar / Aluminum Non-Stick Pans

- Özel 3003 alaşım 3 mm kalınlığında alüminyum gövde
- Dupont Teflon Platinum Plus kaplama
- Profesyonel kullanıma uygun paslanmaz çelik saplar
- Doğa dostu: PFOA içermez
- İndüksiyon ocaklara uygundur
- Made from Special 3003 alloy aluminium
- Stay Cool Stainless Steel Pipe Handles with professional riveting fixing
- Made for Avid Chefs who demand Quality
- Eco Friendly: PFOA Free
- Suitable for induction



26

Alüminyum Tavalar (Platinum Teflon) Aluminum Non Stick Pans (Platinum Teflon)



» Yapışmaz Alüminyum Kızartma Tava
Aluminum Non Stick Fry Pan

Kod Code	Ø (cm) Ø (cm)
12021020	20
12021024	24
12021028	28
12021032	32
12021036	36
12021040	40



» Yapışmaz Alüminyum Krep Tava
Aluminum Non Stick Crepe Pan

Kod Code	Ø (cm) Ø (cm)
12123024	24
12123028	28



» Yapışmaz Alüminyum Wok Tava
Aluminum Non Stick Wok Pan

Kod Code	Ø (cm) Ø (cm)
12144024	24
12144028	28
12144030	30



Karbon Çelik Tavalar Carbon Steel Pans (Heavy Duty)

- Tüm gövde ve taban 3 mm yüksek kalite karbon çelik
- 3 mm gövde kalınlığı, ısıyı uzun süreli tuttuğu için mühürlemeye uygun
- Fırında kullanılabilir
- Çok düşük ve çok yüksek ısılarda kullanılabilir
- İndüksiyon ocaklara uygundur



- This high quality, carbon steel pan is suitable for searing, as its thickness allows for long re-heating at high temperatures
- Steel cookware achieves and maintains both very low and very high temperatures, making these pans a highly effective and versatile cooking piece
- This pan has a flat iron handle affixed with rivets
- The 1/8" (3mm) thickness is uniform throughout the pan
- Suitable for induction



» Karbon Çelik Kızartma Tavası

Carbon Steel Fry Pan

Kod Code	Ø (cm) Ø (cm)	Kalınlık (mm) Thickness (mm)
50050020	20	3,0
50050024	24	3,0
50050028	28	3,0
50050032	32	3,0

» Karbon Çelik Wok Tava

Carbon Steel Wok Pan

Kod Code	Ø (cm) Ø (cm)	Kalınlık (mm) Thickness (mm)
50051032	32	3,0

» Karbon Çelik Blinis Tava

Carbon Steel Blinis Pan

Kod Code	Ø (cm) Ø (cm)	Kalınlık (mm) Thickness (mm)
50050012	12	2,0

27



» Bambu Altık (Mıknatıslı)

Bamboo Base w/High Heat Magnet

Kod Code	Ø (cm) Ø (cm)
50010001	12

* Fiyata tava dahil değildir.
* Pan is not included in price



Sac Tavalar (Yapışmaz Kaplı) Carbon Steel Pans Non Stick Coated

- Paslanmayı önleyici yapışmaz kaplama
- Özel perçinlenmiş düz çelik saplar ile rahat kullanım
- Yapışmaz kaplı
- İndüksiyon ocaklara uyumlu
- Uzun ömürlü



- Non Stick Coated to control rust
- Perfect for seasoning and searing meats
- Professional Riveted Flat Steel Handles for easy handling
- Long Lasting
- Induction Compatible



» Sac Kızartma Tava
Non-Stick Carbon Steel Fry Pan

Kod Code	Ø (cm) Ø (cm)
50010226	26
50010230	30



» Sac Çift Saplı Tava (Paella)
Non-Stick Carbon Steel Paella Pan

Kod Code	Ø (cm) Ø (cm)
50010022	22
50010026	26
50010034	34



» Sac Krep Tava
Non-Stick Carbon Steel Crepe Pan

Kod Code	Ø (cm) Ø (cm)
50010028	28

28



» Sac Wok Tava
Wok Pan w/Wooden Handle

Kod Code	Ø (cm) Ø (cm)
50018026	26
50018030	30



» Silikon Tava Sapı
Silicone Cover for Handle

Kod Code
50010000

* Karbon Çelik ve Sac Tavaların saplarında kullanıma uygundur.

* Suitable for Carbon Steel NonStick Coated Pans and Carbon Steel Heavy Duty Pans

- Bakteri oluşumunu önleyen üç kat emaye ile kaplıdır
- Buhar tutucu özel kapak tasarımı sayesinde vitamin ve mineral kaybını önler
- Isıyı hızla emer, uzun süre muhafaza eder
- Mükemmel iletkenliği ve eşit ısı dağılımı ile enerji tasarrufu sağlar
- Kesilme ve çizilmeye karşı dayanıklı yüzey metal ekipmanları kullanabilme rahatlığı sağlar
- Her tür ocak ve fırında kullanılabilme özelliği
- Yapışmaz, kolay temizlenebilir



- Triple enamel coating that ensures hygiene
- Vapor binding cover, prevents the loss of vitamins and minerals
- It absorbs heat rapidly and protects it for a long time
- Also good for food presentation at buffets
- Energy saving is provided by perfect thermal conductivity and balanced heat distribution
- Cut and scratch resistant surface provides the convenience of using metal equipments
- Suitable for all kinds of energy hobs and ovens
- Non - stick, easy to clean



» Mini Tencere / Mini Pot)

Kod Code	Model Model	Øxh (cm) Øxh (cm)	Lt Lt
48011110	Tencere/ Pot	10	0,35
48013110	Altılık/ Wooden Base		
48014110	3'lü Altılık /Wooden Base for 3 Pots		



» Tencere / Pot)

Kod Code	Model Model	Øxh (cm) Øxh (cm)	Lt Lt
48011120	Tencere/ Pot	20	2,56
48013120	Altılık/ Wooden Base		
48011124	Tencere/ Pot	24	4,93
48013124	Altılık/ Wooden Base		
48011128	Tencere/ Pot	28	6,80
48013128	Altılık/ Wooden Base		



29



» Yayvan Tencere / Shallow Pot)

Kod Code	Model Model	Øxh (cm) Øxh (cm)	Lt Lt
48011424	Tencere/ Pot	24	2,40
48013424	Altılık/ Wooden Base		
48011428	Tencere/ Pot	28	3,40
48013428	Altılık/ Wooden Base		



Döküm Tavalarda /Cast Iron Pans



» Döküm Tepsi
Cast Iron Grill Tray Pan

Kod Code	Model Model	Ölçü (cm) Dims. (cm)
48012230	Tava/Pan	22x30
48022230	Altılık/Wood Base	
48012640	Tava/Pan	26x40
48022640	Altılık/Wood Base	



480 481 482



» Döküm Yuvarlak Tava
Cast Iron Round Pan

Kod Code	Model Model	Ø (cm) Ø (cm)
48010016	Tava/Pan	16
48020016	Altılık/Wood Base	
48010020	Tava/Pan	20
48020020	Altılık/Wood Base	
48021016	Seramik Sos Kabı Ceramic Sauce Cup	



» Döküm Izgara Tava
Cast Iron Rectangular Grill Pan

Kod Code	Model Model	Ölçü (cm) Dims. (cm)
48012647	Tava/Pan	26x47
48022647	Altılık/Wood Base	

30



» Döküm Fajita Tavası
Cast Iron Fajita Pan

Kod Code	Model Model	Ölçü (cm) Dims. (cm)
48011824	Tava/Pan	18,5x24,5
48021824	Altılık/Wood Base	
48011529	Tava/Pan	15x29,5
48021529	Altılık/Wood Base	



» Döküm Balık Tavası
Cast Iron Fish Pan

Kod Code	Model Model	Ölçü (cm) Dims. (cm)
48011524	Tava/Pan	15x24,5
48021524	Altılık/Wood Base	



» Döküm Sac Kavrurma Tavası
Cast Iron Sheet Roasting Pan

Kod Code	Model Model	Ø (cm) Ø (cm)
48018020	Tava/Pan	20
48028020	Altılık/Wood Base	
48018028	Tava/Pan	28
48028028	Altılık/Wood Base	



» Döküm Pizza-Krep-Pankek Tava
Cast Iron Pizza-Creppe-Pancake Pan

Kod Code	Model Model	Ø (cm) Ø (cm)
48011220	Tava/Pan	20
48021220	Altılık/Wood Base	
48011227	Tava/Pan	28
48021228	Altılık/Wood Base	



» Döküm Izgara Tava (Porsiyonluk)
Cast Iron Grill Pan (1 Portion)

Kod Code	Model Model	Ölçü (cm) Dims. (cm)
48011616	Tava/Pan	16x16
48021616	Altılık/Wood Base	



» Döküm Mini Izgara Tava
Cast Iron Mini Grill Pan

Kod Code	Model Model	Ölçü (cm) Dims. (cm)
48011522	Tava/Pan	15x22
48021522	Altılık/Wood Base	



» Döküm Kare Izgara Tava
Cast Iron Square Grill Pans

Kod Code	Model Model	Ölçü (cm) Dims. (cm)
48012626	Tava/Pan	26x26
48022626	Altılık/Wood Base	



» Döküm Yarı Düz Izgara Tava
Cast Iron Semi Grill/Semi Flat Pan

Kod Code	Model Model	Ölçü (cm) Dims. (cm)
48002632	Tava/Pan	26x32
48022732	Altılık/Wood Base	



» Döküm Izgara Yüzey Dörtgen Tava
Cast Iron Ribbed Skillet

Kod Code	Model Model	Ölçü (cm) Dims. (cm)
48032632	Tava/Pan	26x32
48042632	Altılık/Wood Base	



480 481 482



» Döküm Izgara Yüzey Tava
Cast Iron Ribbed Frying Pan

Kod Code	Model Model	Ø (cm) Ø (cm)
48011224	Tava/Pan	24
48013224	Altılık/Wood Base	
48011228	Tava/Pan	28
48013228	Altılık/Wood Base	



480 481 482



» Döküm Düz Yüzey Tava
Cast Iron Frying Pan

Kod Code	Model Model	Ø (cm) Ø (cm)
48011324	Tava/Pan	24
48013324	Altılık/Wood Base	
48011328	Tava/Pan	28
48013328	Altılık/Wood Base	



480 481 482



» Döküm Sahan
Cast Iron French Omelette Pan

Kod Code	Model Model	Ø (cm) Ø (cm)
48011322	Tava/Pan	22
48013322	Altılık/Wood Base	



480 481 482

- İçi daha yumuşak dışı daha çıtır et, tavuk, balık ve sebzeleriniz için ideal pişirme
- Patentli formül sayesinde nemi koruyarak küçülmeden, kurumadan yeterli miktarda havayla temas ederek mükemmel kızarma ve çıtırılık sağlar
- Zincirin delikleri sayesinde pişirme esnasında yemeği rahatça soslayabilme
- Yemeği fırından çıkarttıktan sonra dinlendirme esnasında sıcak tutar
- Pişirme esnasında çelik ısıyı eşit iletir bu sayede hiç bir bölge çığ kalmaz
- Elde ve bulaşık makinesinde yıkanabilir
- Gıdayla temasa uygun yüksek kalite çelikten üretilmiştir (NF A36-711)
- Çevre dostu

- Measuring 40x40 cm Roasteasy covers the largest chicken or smaller size roast joint
- Great alternative to tinfoil
- Allows venting and not sweating
- Allows perfect browning and crisping
- Reduces burning
- Roasteasy can be used during or after cooking
- Ideal for use in convection ovens
- Ideal for cooking meats, chicken or fish
- Can be used for barbecuing steaks & prawns also be used as an ideal diffuser on the barbecue
- Reduces shrinkage
- Retains natural juices and enhances flavours
- Maintains texture and shape for perfect carving
- Roasteasy is a reusable whole of lifetime product
- Stays warm allowing your roast to rest & relax without losing its heat
- Roasteasy is dishwasher proof, easy-clean and reduces fat spit and spray in oven interiors





» Paslanmaz Çelik Pişirme Örtüsü
Stainless Steel Roasteasy

Kod Code	Ölçü Dimensions
65620001	40x40

Fırın Tepsileri / Roasting Pans



» Kapaklı
Roasting Pan w/Clip-on Cover

Kod Code	Ölçü Dims. (cm)
30714565	40x60x5
30714568	40x60x8
30714561	40x60x10
30715355	50x35x5
30715358	50x35x8
30715310	50x35x10
30715705	50x70x5
30715708	50x70x8
30715710	50x70x10



» Kapaksız
Tapered Roasting Pan

Kod Code	Ölçü Dims. (cm)
30704565	40x60x5
30704568	40x60x8
30704561	40x60x10
30705355	50x35x5
30705358	50x35x8
30705310	50x35x10
30705705	50x70x5
30705708	50x70x8
30705710	50x70x10



» Kapak
Cover

Kod Code	Ölçü Dims. (cm)
30705711	40x60
30705713	50x35
30705712	50x70

34



» Yuvarlak
Round Roasting Pan (S / S)

Kod Code	Øxh (cm) Øxh (cm)
30703805	36x5
30704505	45x5
30705005	50x5
30706005	60x5



» Alüminyum Pizza Tepsisi
Aluminium Pizza Tray

Kod Code	Ø (cm) Ø (cm)
43010018	18
43010020	20
43010022	22
43010024	24
43010026	26
43010028	28
43010030	30
43010032	32
43010040	40



» Emaye Kaplı
Enamel Coated

Kod Code	Ölçü (mm) Dims. (mm)	Model Model	Lt Lt
31811020	530x325	1/1-20	2,5
31811040	530x325	1/1-40	5
31811065	530x325	1/1-65	9



» Seramik Kaplı
Ceramic Coated (Steel)

Kod Code	Ölçü(mm) Dims. (mm)	Model Model	Lt Lt
31911020	530x325	1/1-20	2,5
31921020	650x530	2/1-20	5



» Yapışmaz Kaplı GN (S/S)
Nonstick GN (S/S)

Kod Code	Ölçü(mm) Dims. (mm)	Model Model	Lt Lt
31311020	530x325	1/1-20	2,5
31321020	650x530	2/1-20	5



» Yapışmaz GN (Alüminyum)
Nonstick GN Aluminum

Kod Code	Ölçü(mm) Dims. (mm)	Model Model	Lt Lt
31311030	530x325	1/1-20	2,5
31321030	650x530	2/1-20	5

iDinium

- Patentli özel alüminyum alaşım sayesinde optimum ısı koruma
- İşlem görmüş yüksek kalite yapışmaz kaplama
- Her tip fırında kullanıma uygun
- Kısa sürede hızlı pişirme
- Ekmek pişirmek için mükemmel uyum
- Kolay temizlik

*Patentli ürün.



- Patented aluminum alloy & high class non stick coating
- Oil free - healthier & juicier cooking
- Faster cooking
- Also recommended for bread baking
- Optimal retention and heat transmission
- Easy cleaning
- Dish washer safe

*Patented



» 1/1 Fırın Tepsisi
1/1 Roasting Pan

Kod Code	Ölçü(mm) Dims. (mm)	Model Model
11151120	530x325	1/1-20
11151140	530x325	1/1-40



» 1/2 Fırın Tepsisi
1/2 Roasting Pan

Kod Code	Ölçü(mm) Dims. (mm)	Model Model
11151220	325x365	1/2-20
11151240	325x365	1/2-40
11151260	325x365	1/2-60



» 2/3 Fırın Tepsisi
2/3 Roasting Pan

Kod Code	Ölçü(mm) Dims. (mm)	Model Model
11152320	354x325	2/3-20
11152340	354x325	2/3-40



» 1/3 Fırın Tepsisi
1/3 Roasting Pan

Kod Code	Ölçü(mm) Dims. (mm)	Model Model
11151340	325x176	1/3 - 40



» 1/6 Fırın Tepsisi
1/6 Roasting Pan

Kod Code	Ölçü(mm) Dims. (mm)	Model Model
11151660	176x162	1/6 - 60









Hazırlık

Preparing





Standart Gastronorm Kvetler
GN Food Pans

		Kod Code	Derinlik (mm) Depth (mm)	Lt Lt
	2/1 650x530	31021010	10	2,5
		31021020	20	5,0
		31021040	40	10,0
		31021065	65	18,5
		31021100	100	28,5
		31021150	150	42,5
		31021200	200	57,5
	1/1 530x325	31011010	10	1,25
		31011020	20	2,5
		31011040	40	5,0
		31011065	65	9,0
		31011100	100	14,0
		31011150	150	21,0
		31011200	200	28,0
	2/3 354x325	31023020	20	1,5
		31023040	40	3,0
		31023065	65	5,5
		31023100	100	9,0
		31023150	150	13,0
		31023200	200	18,0
	1/2 325x265	31012020	20	1,25
		31012040	40	2,0
		31012065	65	4,0
		31012100	100	6,5
		31012150	150	9,5
		31012200	200	12,5
	1/3 325x176	31013020	20	0,75
		31013040	40	1,5
		31013065	65	2,5
		31013100	100	4,0
		31013150	150	5,7
		31013200	200	7,8

Standart Gastronorm Kuvetler
GN Food Pans





		Kod Code	Derinlik (mm) Depth (mm)	Lt Lt
	1/4 265x162	31014020	20	0,5
		31014040	40	1,0
		31014065	65	1,8
		31014100	100	2,8
		31014150	150	4,0
		31014200	200	5,5
	2/4 530x162	31024020	20	0,5
		31024040	40	1,3
		31024065	65	2,3
		31024100	100	5,2
	2/8 325x132	31028065	65	1,0
		31028100	100	2,0
	1/6 176x162	31016065	65	1,0
		31016100	100	1,6
		31016150	150	2,4
		31016200	200	3,4
	1/9 176x108	31019065	65	0,6
		31019100	100	1,0

Süzgeçli Gastronorm Küvetler / Perforated GN Food Pans

Süzgeçli Gastronorm Küvetler
Perforated GN Food Pans



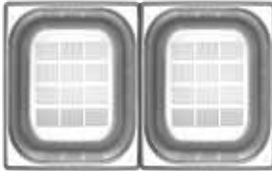

40

		Kod Code	Derinlik (mm) Depth (mm)
	2/1 650x530	30921020	20
		30921040	40
		30921065	65
		30921100	100
		30921150	150
		30921200	200
	1/1 530x325	30911020	20
		30911040	40
		30911065	65
		30911100	100
		30911150	150
		30911200	200
	2/3 354x325	30923020	20
		30923040	40
		30923065	65
		30923100	100
		30923150	150
		30923200	200
	1/2 325x265	30912020	20
		30912040	40
		30912065	65
		30912100	100
		30912150	150
		30912200	200

Süzgeçli Gastronorm Küvetler / Perforated GN Food Pans

Süzgeçli Gastronorm Küvetler
Perforated GN Food Pans

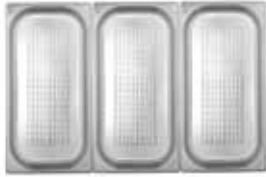

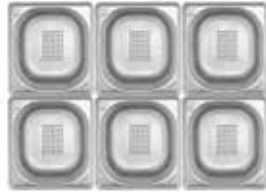
		Kod Code	Derinlik (mm) Depth (mm)
	1/3 325x176	30913020 30913040 30913065 30913100 30913150 30913200	20 40 65 100 150 200
	1/4 265x162	30914020 30914040 30914065 30914100 30914150 30914200	20 40 65 100 150 200
	1/6 176x132	30916065 30916100 30916150 30916200	65 100 150 200

41



Saplı Gastronorm Kvetler / GN Food Pans w/Handle



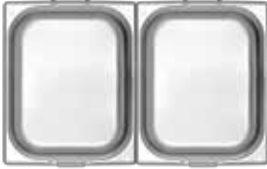

Saplı Gastronorm Kvetler
GN Food Pans w/Handle

		Kod Code	Derinlik (mm) Depth (mm)	Lt Lt
	2/1 650x530	31121065	65	18,5
		31121100	100	28,5
		31121150	150	42,5
		31121200	200	57,5
	1/1 530x325	31111065	65	9,0
		31111100	100	14,0
		31111150	150	21,0
		31111200	200	28,0
	2/3 354x325	31123065	65	5,5
		31123100	100	9,0
		31123150	150	13,0
		31123200	200	18,0
	1/2 325x265	31112065	65	4,0
		31112100	100	6,5
		31112150	150	9,5
		31112200	200	12,5

Saplı Gastronorm Kvetler / GN Food Pans w/Handle

Saplı Gastronorm Kvetler
GN Food Pans w/Handle

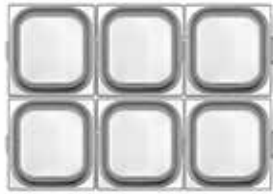

		Kod Code	Derinlik (mm) Depth (mm)	Lt Lt
	1/3 325x176	31113065	65	2,5
		31113100	100	4,0
		31113150	150	5,7
		31113200	200	7,8
	1/4 265x162	31114065	65	1,8
		31114100	100	2,8
		31114150	150	4,0
		31114200	200	5,5
	1/6 176x162	31116065	65	1,0
		31116100	100	1,6
		31116150	150	2,4
		31116200	200	3,4

43





plast|port®

» Standart

Standart

Kod Code	Model Model	Ölçü (mm) Dim (mm)
31921530	2/1	650x530
31911325	1/1	530x325
31923325	2/3	354x325
31924300	2/4	530x162
31928300	2/8	325x132
31912265	1/2	325x265
31913176	1/3	325x176
31914162	1/4	265x162
31916162	1/6	176x162
31919108	1/9	176x108

» Sap Delikli

Lid w/Handle Hole

Kod Code	Model Model	Ölçü (mm) Dim (mm)
32100021	2/1	650x530
32100011	1/1	530x325
32100023	2/3	354x325
32100012	1/2	325x265
32100013	1/3	325x176
32100014	1/4	265x162
32100016	1/6	176x162

» Keççe Delikli

Lid w/Ladle Hole

Kod Code	Model Model	Ölçü (mm) Dim (mm)
32100121	2/1	650x530
32100111	1/1	530x325
32100123	2/3	354x325
32100112	1/2	325x265
32100113	1/3	325x176
32100114	1/4	265x162
32100116	1/6	176x162

» Polikarbonat GN Kapak

PC GN Lid

Kod Code	Model Model	Ölçü (mm) Dim (mm)
46010011	1/1	530x325
46010012	1/2	325x265
46010013	1/3	325x176
46010014	1/4	265x162
46010016	1/6	176x162
46010019	1/9	176x108

44



plast|port®



plast|port®

» Sızdırmaz Contalı

Lid w/Hermetic Seal

Kod Code	Model Model	Ölçü (mm) Dim (mm)
31923311	1/1	530x325
31923312	1/2	325x265
31923313	1/3	325x176
31923314	1/4	265x162

» PC Sızdırmaz Contalı (PC GN Küvet uyumlu)

PC Lid w/Hermetic Seal for PC GN Containers

Kod Code	Model Model	Ölçü (mm) Dim (mm)
46011011	1/1	530x325
46011012	1/2	325x265

* GN Küvet fiyata dahil değildir.

* GN pan is not included in price

» PC Sızdırmaz Contalı (Paslanmaz GN Küvet uyumlu)

PC Lid w/Hermetic Seal for S/S GN Containers

Kod Code	Model Model	Ölçü (mm) Dim (mm)
46012011	1/1	530x325

* GN Küvet fiyata dahil değildir.

* GN pan is not included in price



» Dondurma Küveti
GN Ice Cream Pan

Kod Code	Lt Lt	Ölçü (mm) Dim (mm)
31236065	4	360x170x65
31236100	6,1	360x170x100
31236120	7,3	360x170x120
31236150	9,2	360x170x150



plast|port®

» PP Dondurma Küveti
PP GN Ice Cream Pan

Kod Code	Ölçü (mm) Dim (mm)	Lt Lt
46010002	360x170x110	4,5



plast|port®

» PC Dondurma Küveti
PC GN Ice Cream Pan

Kod Code	Ölçü (mm) Dim (mm)	Lt Lt
46010001	360x170x110	4,5



» Meze Küveti
Appetizer Pan

Kod Code	Ölçü (mm) Dim (mm)
35011929	195x295x35
35012333	230x330x42
35012538	257x380x47
35012843	285x430x51
35013253	325x530x52



» Seramik Kaplı GN Küvet
Ceramic Coated (Steel) Pan

Kod Code	Ölçü (mm) Dim (mm)	Model Model	Lt Lt
31911020	530x325	1/1-20	2,5
31921020	650x530	2/1-20	5



» Emaye Kaplı GN Küvet
Enamel Coated Pan

Kod Code	Ölçü (mm) Dim (mm)	Model Model	Lt Lt
31811020	530x325	1/1-20	2,5
31811040	530x325	1/1-40	5
31811065	530x325	1/1-65	9

45



» Yapışmaz Kaplı GN (Paslanmaz)
Nonstick GN Pan

Kod Code	Ölçü (mm) Dim (mm)	Model Model	Lt Lt
31311020	530x325	1/1-20	2,5
31321020	650x530	2/1-20	5



» Yapışmaz Kaplı GN (Alüminyum)
Nonstick GN Pan Alüminyum

Kod Code	Ölçü (mm) Dim (mm)	Model Model	Lt Lt
31311030	530x325	1/1-20	2,5
33121030	650x530	2/1-20	5



plast|port®

» PP Pizza Hamur Teknesi
PP Dough Tray

Kod Code	Ölçü (mm) Dim (mm)	Lt Lt
46010026	400x600x77	16,8



» GN 1/1 Porselen

GN 1/1 Porcelain Food Pan

Kod Code	Ölçü (mm) Dim (mm)
70020101	530x325



» GN 1/2 Porselen

GN 1/2 Porcelain Food Pan

Kod Code	Ölçü (mm) Dim (mm)
70020102	325x265



» GN 2/3 Porselen

GN 2/3 Porcelain Food Pan

Kod Code	Ölçü (mm) Dim (mm)
70020203	354x325



» GN 1/3 Porselen

GN 1/3 Porcelain Food Pan

Kod Code	Ölçü (mm) Dim (mm)
70020103	325x176



» Yuvarlak Porselen

Round Porcelain Food Pan

Kod Code	Ölçü (Cm) Dim (Cm)
70020100	39x6,5



» Yuvarlak Bölmeli Porselen

Round Divided Porcelain Food Pan

Kod Code	Ölçü (cm) Dim (cm)
70021100	39x6,5



» Yuvarlak Bölmeli Tepsi

Round Divided Food Pan (S/S)

Kod Code	Ölçü (cm) Dim (cm)
70023100	38,5x38,5x6,5



» Yuvarlak Tepsi

Round Food Pan (S/S)

Kod Code	Ölçü (cm) Dim (cm)
30703565	35x6,5





» Süzgeç Taban

Drainer Plate

Kod Code	Ölçü (mm) Dim (mm)	Model Model
80026565	465x265	1/1
80026523	285x265	2/3
80026520	265x220	1/2
80026515	265x115	1/3



» Tel Izgara

Wire Grid

Kod Code	Ölçü (mm) Dim (mm)	Model Model
80022530	530x325	GN 1/1 (304-18/10)
80026530	650x530	GN 2/1 (304-18/10)
80025425	600x400	Tel Izgara/Wire Grid (304-18/10)
50701530	530x325	GN 1/1 (201-18/02)
50701650	650x530	GN 2/1 (201-18/02)
50701600	600x400	Tel Izgara/Wire Grid (201-18/02)



» Gastronom Süzgeç

Colander for GN Pan

Kod Code
70021100

* GN Küvet fiyata dahil değildir.
* GN Pan not included in price.



» GN 1/1 Yükseltici

GN 1/1 Angled Adaptor Plate

Kod Code	Ölçü (mm) Dim (mm)
54010002	530x325

* GN Küvet fiyata dahil değildir.
* GN Pan not included in price.



» Sıcak Kap / GN Tutucu S/S

S/S Grid for Hot Dishes

Kod Code
62010041

* GN Küvet fiyata dahil değildir.
* GN Pan not included in price.

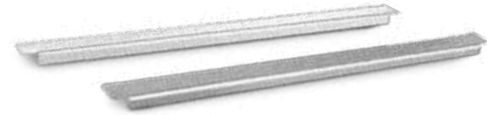

» GN Destek Aparatı

GN Adjustment Bar

Kod Code	Ölçü (mm) Dim (mm)	Model Model
50020032	325	GN 1/1
80020053	530	GN 2/1

Melamin Gastronorm Kuvetler Melamine GN Pans









- Isı ve korozyona karşı dayanıklı
- Kokusuz
- Hafif, kırılmaya karşı dayanıklı
- Deforme olmaz
- Toksik madde içermez
- Bulaşık makinasında yıkanabilir

- Heat resistant - 70° / + 120° C
(Shock resistant up to 120° C)
- Corrosion resistant
- Light weight
- Break resistant
- Deformation free
- Toxic free
- Odor free
- Low heat conductor
- Dishwasher safe

* Pişirmede ve Bain Marie'de kullanılmaz

* Not suitable for direct flame or any cooking type

Melamin Gastronorm Kvetler Melamine GN Pans		Kod Code	Derinlik (mm) Depth (mm)	Lt Lt
	1/1 530x325	58001165 58011100	65 100	7,1 10,2
	1/2 325x265	58001220 58001240 58001265 58012100	20 40 65 100	0,8 1,65 3,4 5,5
	1/3 325x176	58001320 58001365 58013100	20 65 100	0,5 2,0 3,15
	1/4 265x162	58001420 58001465 58014100	20 65 100	0,5 1,35 2,0
	1/6 176x162	58001665 58016100	65 100	0,8 1,25
	1/9 176x108	58001965	65	0,6

* Tm melamin GN kvetlerin altında kaymayı önleyici 4 adet silikon vardır.

* Non-slip silicones on the bottom corners.

plast | port[®]





Polikarbonat Gastronom Küvetler

- Yüksek darbe dayanımına sahiptir kırılmaz
- Yüksek darbe dayanımından dolayı köşe ve kenar deformasyonu yaşanmaz
- Asit dayanımı yüksektir, delinmez
- +100°C / - 40°C ısıya dayanıklıdır
- Mikrodalga fırın kullanımına uygundur
- İç içe istiflenebilir, yer tasarrufu sağlar
- Hafiftir, kolay taşınabilir
- İnsan sağlığına zararlı hammadde içermez
- Şeffaf yapısı sayesinde kullanım kolaylığı sağlar

Polycarbonate GN Pans

- High impact resistance, unbreakable
- No corner and border deformation due to high impact resistance
- High acid-proof, impenetrable
- Heat endurance between +100°C / -40°C
- Suitable for microwave oven
- Stackable one within the other
- Light , easy to carry
- No hazardous substances on human health
- Easy to use due to the transparent structure







Polikarbonat Őeffaf
Gastronorm Kvetler
Polycarbonate GN Pans



		Kod Code	Derinlik (mm) Depth (mm)
	1/1 530x325	46011065 46011100 46011150 46011200	65 100 150 200
	Kapak/ Lid	46010011	
	1/2 325x265	46012065 46012100 46012150 46012200	65 100 150 200
	Kapak/ Lid	46010012	
	1/3 325x176	46013065 46013100 46013150	65 100 150
	Kapak/ Lid	46010013	
	1/4 265x162	46014065 46014100 46014150	65 100 150
	Kapak/ Lid	46010014	
	1/6 176x162	46016065 46016100 46016150	65 100 150
	Kapak/ Lid	46010016	
	1/9 176x108	46019065 46019100 46019150	65 100 150
	Kapak/ Lid	46010019	

Polikarbonat Siyah
Gastronorm Kvetler
Polycarbonate Black
GN Pans

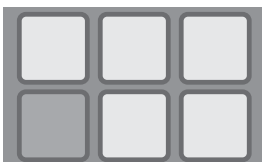

		Kod Code	Derinlik (mm) Depth (mm)
	1/1 530x325	46111065 46111100 46111150 46111200	65 100 150 200
	Kapak/ Lid	46010011	
	1/2 325x265	46112065 46112100 46112150 46112200	65 100 150 200
	Kapak/ Lid	46010012	
	1/3 325x176	46113065 46113100 46113150	65 100 150
	Kapak/ Lid	46010013	
	1/4 265x162	46114065 46114100 46114150	65 100 150
	Kapak/ Lid	46010014	
	1/6 176x162	46116065 46116100 46116150	65 100 150
	Kapak/ Lid	46010016	
	1/9 176x108	46119065 46119100 46119150	65 100 150
	Kapak/ Lid	46010019	

Polikarbonat Ölçülü Kare Saklama Kapları

PC Square Food Storage Container w/Graduations

- Saklama, hazırlık, servis ve taşıma için idealdir
- Kırılmaz polikarbonattan imal edilmiştir
- Kırılmaz, çatlamaz, bükülmez ve çökme yapmaz
- 40 ° C' den 99 ° C' ye kadar dirençlidir
- Lt ve Qt ölçeği envanter düzeni için kullanışlıdır
- Kolay temizlenebilir

- Ideal for storing, preparing, serving display and transportation
- Made in unbreakable polycarbonate
- Nonbreakable, nonbending, can not be cracked or bent
- Withstand temperatures from 40 ° C to 99 ° C
- Standard and metric graduation markings, to easy inventory management
- Easy cleaning





» 18 Litre

18 Lt.

Kod
Code

62030018

Ölçü (cm)
Dim (cm)

28,5x28,5x32



» 12 Litre

12 Lt.

Kod
Code

62030012

Ölçü (cm)
Dim (cm)

28,5x28,5x21



» 8 Litre

8 Lt.

Kod
Code

62030008

Ölçü (cm)
Dim (cm)

22,5x22,5x23



55



» 6 Litre

6 Lt.

Kod
Code

62030006

Ölçü (cm)
Dim (cm)

22,5x22,5x19



» 3,8 Litre

3,8 Lt.

Kod
Code

62030004

Ölçü (cm)
Dim (cm)

18,2x18,2x19



» 2 Litre

2 Lt.

Kod
Code

62030002

Ölçü (cm)
Dim (cm)

18x18x10



» 1/1

1/1

Kod Code	Ölçü (mm) Dim (mm)
-------------	-----------------------

46021065	1/1-65
46021100	1/1-100
46021150	1/1-150
46021200	1/1-200
46020011	Kapak/Lid

» 1/2

1/2

Kod Code	Ölçü (mm) Dim (mm)
-------------	-----------------------

46022065	1/2-65
46022100	1/2-100
46022150	1/2-150
46022200	1/2-200
46020012	Kapak/Lid

» 1/3

1/3

Kod Code	Ölçü (mm) Dim (mm)
-------------	-----------------------

46023065	1/3-65
46023100	1/3-100
46023150	1/3-150
46020013	Kapak/Lid

56



» 1/4

1/4

Kod Code	Ölçü (mm) Dim (mm)
-------------	-----------------------

46024065	1/4-65
46024100	1/4-100
46024150	1/4-150
46021014	Kapak/Lid

» 1/6

1/6

Kod Code	Ölçü (mm) Dim (mm)
-------------	-----------------------

46021665	1/6-65
46026100	1/6-100
46026150	1/6-150
46020016	Kapak/Lid

» 1/9

1/9

Kod Code	Ölçü (mm) Dim (mm)
-------------	-----------------------

46029065	1/9-65
46029100	1/9-100
46029150	1/9-150
46020019	Kapak/Lid



» A

A

Kod Code	Model Model	l (mm) Dim (mm)	h (mm) h (mm)	Lt Lt
31622235	A1	240x240	235	13
31622160	A2	240x240	160	9
31622075	A3	240x240	75	4
31622300	A (Kapak / Lid)	240x240		



» B

B

Kod Code	Model Model	l (mm) Dim (mm)	h (mm) h (mm)	Lt Lt
31611235	B1	155x155	235	5
31611160	B2	155x155	160	3,5
31611075	B3	155x155	75	1,5
31611300	B (Kapak / Lid)	155X105		



» C

C

Kod Code	Model Model	l (mm) Dim (mm)	h (mm) h (mm)	Lt Lt
31610160	C2	155x155	160	2,5
31610075	C3	155x155	75	1
31610055	C4	155x155	55	0,5
31610300	C (Kapak / Lid)	155X105		



plast|port®

» Sebze Kurutucu
Salad Spinner

Kod Code	Kapasite Capacity
46700020	20 Lt



» Sebze Tornası (Le Rouet Gourmet)
Turning Slicer Le Rouet Gourmet w/3 Knives

Kod Code	Ölçü (cm) Dim. (cm)
62050011	36x13,5x24,3



58



Made in France

» Japon Tornası 3 Bıçaklı (Plastik)
Turning Slicer Plastic

Kod Code	Ölçü (cm) Dim. (cm)
62050010	32,5x15,3x22

- 4 değişik kesim çeşidi (Dilimleme, Jülyen, Rende ve Zest)
- 1-10 mm arası ultra ince kesim kalınlığı
- Paslanmaz çelik sağlam ve profesyonel gövde
- V-şeklinde entegre bıçak
- Paslanmaz çelik yüksek kalite bıçaklar
- Plastik tutma aparatıyla güvenli kullanım
- Kaymaz kauçuk ayaklar

- Multi-cuts : smooth slices, Juliennes, grate and zest
- Ultra-thin slices from 1 to 10 mm
- Robust and professional : in stainless steel
- V-shaped blade integrated
- Blades in pro. quality stainless steel
- Easy to use
- Complete safety thanks to the pusher, storage box and receptable for vegetables
- Compact storage



Made in France

de BUYER
DEPUIS 1830

» Mandalin Kesme Ünitesi

Mandoline

Kod
Code

63010025

- 2, 3, 4 mm bıçaklar
- Jülyen kesim, dilimleme, çubuk kesim ve angel hair kesim
- Kağıt inceliğinde kesebilme özelliği
- Ayarlanabilir kesim kalınlığı

- Exceptional cutting: Paper-thin and crispy slices of fruits and vegetables
- Adjustable cutting thickness
- Removable blade for easy cleaning
- Come w/3 interchangeable "comb" blades (2-3-4 mm) and a handle guard

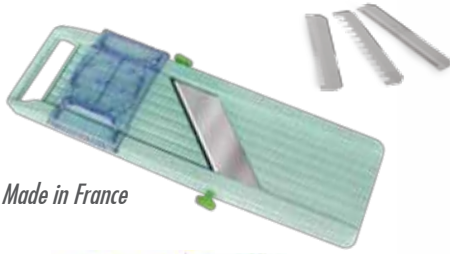

Made in France



Dilim
Slice

Çubuk
Sticks

Jülyen
Julienne

Angel Hair
Angel Hair

» Mandalin 3 Bıçaklı

Japanese Mandoline

Kod

Code

62050009



Made in France

» Sebze Dograyıcı

Vegetable Wedger

Kod

Code

62050006

Model

Model

6 Dilim/Pcs

62050008 8 Dilim/Pcs



» Ananas Soyma

Pineapple Peeler

Kod

Code

41030005

59



Made in France

» Domates Dilimleyici

Tomato Slicer

Kod

Code

62050007



» Patates Dilimleme

French Fry Cutter

Kod

Code

62050005

Model

Model

Patates Dilimleyici

French Fry Cutter

62050808

8x8 Bıçak

8x8 Blade

62051010

10x0 Bıçak

10x0 Blade



» Patates Dilimleme

French Fry Cutter

Kod

Code

41030003

Ölçü (mm)

Dim. (mm)

9x9

* Bıçaklar ayrı satılır.

* Blades are separate

Ergonomik / Ergonomic

Güvenli ve kolay kullanım için tasarlanmış geniş tutma kolu
Large handles for ease and safety of use

Çok Amaçlı / Multi-Purpose

Herhangi bir alet gerektirmeden kolayca değiştirilebilir itici başlık
Easily interchangeable pusher, no tools required

Rahat Kullanım / Comfortable

İticiyi otomatik geri iten yaylar kolay kullanım sağlar
Pusher return springs for easy use

Verimli / Efficient

Değiştirilebilir bıçak bloğu kolay ve temiz kesim sağlayan sertleştirilmiş çelikten üretilmiştir. Tek hamlede kusursuz kesilmiş ürünler elde edebilirsiniz.
Tempered steel blades for clean, easy cutting. Cutting results guarantee impeccable product presentation and optimal conservation. Interchangeable blade block

Uzun Ömürlü / Hardwearing

Dayanıklı kompozit gövde
Robust composite body

Pratik / Practical

Kesilen ürünler direk cihazın altına yerleştirilen kütvelere toplanır (GN 1/2 max. 100 mm derinlikteki kütve ile kullanılabilir)
Segments collection in a container to be placed directly under the appliance (GN 1/2 container max 100mm deep, not supplied)

Güvenli / Safe

Vakumlu ayaklar yüksek stabilite sağlar
Suction feet, high stability

60



Dilimleyici
Slicer



6 Dilim
8 Dilim /
6 Pieces
8 Pieces

Dilimleyici
Slicer



5 mm /
5 mm

Dilimleyici
Semi-Circle Slicer



2 Dilim / 2 Slices
5 mm / 5 mm

Patates Dilimleyici
French Fries Cutter



8x8 mm / 8x8 mm
10x10 mm / 10x10 mm

Patates Dilimleyici
French Fries Cutter



8x16 mm /
8x16 mm

Doğrayıcı (Göbek Çıkarıcı)
Corer Segmenter



8 Dilim
8 Pieces

- Meyve ve sebzeleri kolay, hızlı ve eşit bir şekilde doğrar
- Maksimum meyve-sebze çapı Ø 80 mm
- *For fast, regular and calibrated wedging of tomatoes, lemons, oranges and potatoes*
- *Maximum diameter of fruit Ø 80 mm*

- Dilimlenmek istenen her meyve sebzeyi kusursuz ve hızlı biçimde dilimler
- Maksimum meyve-sebze çapı Ø 80 mm
- For tomatoes, citrus fruit, kiwis, 5 mm slices
- Maximum diameter of fruit Ø 80 mm

- Özellikle domates dilimlerini sandviçlerde kullanmak için ikiye bölmek üzere tasarlanmıştır
- Aynı anda hem dilimler hem ikiye böler
- *Specially designed to slice tomatoes for use in sandwiches*
- *With large tomatoes, half-slicer are often better suited and easier to use in sandwiches*



» Sebze Meyve Doğrayıcı
Vegetable/Fruit Wedger

Kod Code	Model Model
77505610	Gövde/Body
77505616	6 Dilim/6 Pieces
77505618	8 Dilim/8 Pieces



» Sebze Meyve Dilimleyici
Vegetable Slicer

Kod Code	Model Model
77505610	Gövde/Body
77505611	5 mm Dilim/Slice



» Sebze Meyve Dilimleyici İkiye Bölücü
Semi-Circle Slicer

Kod Code	Model Model
77505610	Gövde/Body
77505629	5 mm Dilim-İkiye bölücü/ 5 mm Semi-circle Slice

61

- Meyvelerin göbeklerini kolayca çıkararak 8 dilime böler
- Maksimum meyve çapı Ø 90 (mm)
- Maksimum göbek çapı Ø 25 (mm)
- *To easily core and slice fresh apples and pears into 8 segments*
- *Maximum diameter of fruit Ø 90 mm*
- *Core diameter Ø 25 mm*

- Ekstra keskin bıçaklar patateslerin kusursuz kesimini sağlar
- Pürüzsüz kesim patatesin pişirken fazla yağ çekmesini engeller
- *With its perfectly sharp blades, it cuts potatoes into neat french fries without tears to avoid the absorption of oil during cooking*
- *Grid format 90 x 90 mm*

- Dikdörtgen kesim patateslerinize ev yapımı görüntüsü verir
- Pürüzsüz kesim patatesin pişirken fazla yağ çekmesini engeller
- *Easily cut fresh potatoes into rectangles for "home-made" chips*
- *Chips are cut cleanly into 8 x 16mm rectangles with no tears*



» Meyve Doğrayıcı Göbek Çıkarıcı
Fruit Corer Segmenter

Kod Code	Model Model
77505610	Gövde/Body
77505619	8 Dilim/8 Corer-segmentes



» Patates Dilimleyici
French Fries Cutter

Kod Code	Model Model
77505610	Gövde/Body
77505626	8x8 mm Dilim/Segment
77505627	10x10 mm Dilim/Segment



» Dikdörtgen Patates Dilimleyici
Rectangular French Fries Cutter

Kod Code	Model Model
77505610	Gövde/Body
77505628	8x16 mm Dilim/Segment



» Püre Makinesi

Food Mill

Kod Code	Ölçü (cm) Dim. (cm)
62050037	37

* Fiyata süzgeçler dahil değildir.

* W/o sieve



» Püre Makinesi Süzgeçleri

Sieve for Food Mill

Kod Code	Delik Ø (mm) Hole Ø (mm)
62050001	1
62050015	1,5
62050002	2
62050003	3
62050004	4



» Püre Makinesi 3 Süzgeçli

Food Mill w/3 Sieves

Kod Code	Ölçü (cm) Dim (cm)
62050031	31

* Süzgeçlerin delik çapları 1.5, 2.5 ve 4 mm'dir.

** Fiyata süzgeçler dahildir.

* Sieves: 1.5, 2.5 ve 4 mm

** w/ Sieves

62



» Tezgah Tip Konserveler Açacağı

Manuel Can Opener

Kod Code	Model Model
41030004	Endüstriyel Industrial
41130004	Alüminyum Aluminum
41230004	Paslanmaz Çelik Stainless Steel



» Çekmeceli Ekmek Kesim

Bread Cutting Board w/Drawer

Kod Code
49000006



» Hamburger Şekillendirici

Hamburger Press

Kod Code	Model Model
41040010	Şekillendirici 10 cm Press w/10 cm
41040012	Hazne 12 cm Chamber 12 cm
41040014	Hazne 14 cm Chamber 14 cm

* 10 cm hazne Şekillendirici fiyatına dahildir.

** Diğer hazneler opsiyoneldir.

* w/10 cm chamber

** Other chambers not included



» Tavuk Makası
Poultry Shears
Kod
Code
40010057



» Çok Amaçlı Mutfak Makası
Multi-Purpose Kitchen Scissors
Kod
Code
83010002



» 5 Bıçaklı Yeşillik Makası
Herb Scissors with 5 Blades
Kod
Code
83010003



» Elma Dilimleyici
Apple Corer/Wedger (S/S)
Kod
Code
62040001



» Çekirdek Çıkarıcı
Olive/Cherry Seed Remover (S/S)
Kod
Code
62040004



» Dekorator
Decorator (S/S)
Kod
Code
62050013

63



» Yumurta Kesici
Egg Slicer (S/S)
Kod
Code
62040005

Model
Doğrayıcı (Saplı) Egg Wedger



» Ceviz Kıracağı
Nut Cracker (S/S)
Kod
Code
62040006



» Sarmısak Ezici
Garlic Press (S/S)
Kod
Code
62040007



» Dışli Parizyen Kaşık

Tomato Corer

Kod
Code

83010004



» Oval Parizyen Kaşık

Oval Melon Baller

Kod
Code

83010005



» Oval Tırtıklı Parizyen Kaşık

Ribbed Oval Melon Baller

Kod
Code

83010006



» Parizyen Kaşık

Melon Baller

Kod Ø (mm)
Code Ø (mm)

83010010 10



» Parizyen Kaşık

Melon Baller

Kod Ø (mm)
Code Ø (mm)

83010015 15



» Parizyen Kaşık

Melon Baller

Kod Ø (mm)
Code Ø (mm)

83010022 22



» Parizyen Kaşık

Melon Baller

Kod Ø (mm)
Code Ø (mm)

83010025 25



» Parizyen Kaşık

Melon Baller

Kod Ø (mm)
Code Ø (mm)

83010030 30



» Dışli Rulet

Pastry Wheel

Kod
Code

83010007



» Açacak ve Kabuk Şekillendirici

Decorator

Kod
Code

40010042



» Üçgen Dekorator

Triangular Decorator

Kod
Code

83010008



» “V” Dekorator

“V” Shaped Decorator

Kod
Code

83010009



» Narenciye Şekilendirici (Tek Delik)
Lemon Striper w/One Hole

Kod
Code

83010031



» Greyfurt Bıçağı
Grapefruit Knife

Kod
Code

83010032



» Narenciye Bıçağı
Citrus Knife

Kod
Code

83010033



» Meyve Şekillendirici
Decorator

Kod
Code

40010033



» Tereyağ Bıçağı
Butter Spreader

Kod
Code

83010034



» Tereyağ Çekici
Butter Curler

Kod
Code

40010030



» Kabak Oyacak
Zucchini Corer

Kod
Code

83010035



» Elma Oyacağı
Apple Corer

Kod
Code

40010043



» Sebze Soyacak
Peeler

Kod
Code

40010029



» Peynir Dilimleyici
Cheese Slicer

Kod
Code

40010031



» Yumuşak Peynir Bıçağı
Cheese Knife

Kod
Code

40010032



» Konserve Açacağı
Can Opener

Kod
Code

40010044

Termometreler / Thermometers

- 0+300°C
- S/S Delici Çubuk/S/S Probe :150 mm
- Ø : 50 mm



» Pişirme/Kızartma Termometresi
Cooking & Frying Thermometer

Kod
Code

62060001



- +54 +88 °C / +130 +190 °F
- S/S Delici Çubuk/S/S Probe :145 mm
- Ø : 50 mm



» Et Termometresi
Meat Thermometer

Kod
Code

62060006

- +50 +300 °C / +100 +600 °F
- Paslanmaz çelik gövde/S/S Body
- Ø : 83 mm
- Mikrodalga fırınlarda kullanılmaz/
Do not use in microwave oven



» Fırın Termometresi
Dial Oven Thermometer

Kod
Code

62060008



66

- -30 +30 °C / -20 +80 °F
- Paslanmaz çelik gövde/S/S Body
- Ø : 50 mm
- Fırın ve Mikrodalga fırınlarda kullanılmaz
Do not use in oven and microwave oven



» Buzdolabı Termometresi
Fridge/Freezer Thermometer

Kod
Code

62060007

- -50 +70 °C / -58 +158 °F
- Kablo : 1 m/Cable : 1 m
- Mıknatıs/Magnetic back
- Max-mini. programlanabilir alarm
Maxi-mini - Programmable alarm only
- Alarm kapatılana kadar çalar
Stop ringing if it is turned off



» Dijital Buzdolabı Termometresi
Digital Fridge Thermometer

Kod
Code

62060002

- 19 saat - 59 dakika zamanlayıcı
Timer 19 h - 59 m
- 19 saat - 59 dakika kronometre
Stopwatch 19 h - 59 m
- Alarm
- Mıknatıslı ve Standlı / Magnetic back
/ Free Standing



» Dijital Zamanlayıcı Saat
Digital Timer

Kod
Code

62060009

- Pişirme anında ısı kontrolü
- Kremalar, karamelize soslar ve çikolata için ideal
- 220 °C'ye kadar dayanıklı sap
- Çıkarılabilir termometre
- Termometre -20° + 200°C
- 385 mm uzunluk
- Su geçirmez
- Bulaşık makinasında yıkanmaya uygun değildir

- Control the temperature of your dish during cooking, while mixing at the same time
- Ideal for creams, caramelized sugar, chocolate
- Handle resists up to 220°C, dishwasher safe
- Removable thermometer -20° to +200°C, precision 0.1°C, reliability to 1°C
- 385 mm length
- Tight against water splashing, not suitable for dishwasher



» Spatula Termometre
Spatula Thermometer
Kod
Code
77503090

- +80 +200°C
- Kademeli daldırma 70 mm
- Civasız kırmızı göstere
- +/- 350 mm uzunluk
- Paslanmaz çelik koruma kabı
- Fırın ve Mikrodalga fırınlarda kullanılmaz

- +80 +200°C
- Partial immersion 70 mm
- In glass-red liquid filled
- +/- 350 mm length
- w/Stainless Steel protection sleeve
- Not suitable for ovens and microwaves



» Şeker Termometresi
Sugar Thermometer
Kod
Code
62060003

67

NEW



» Dijital Cep Termometresi
Digital Pocket Thermometer
Kod
Code
62060010



» Dijital Cep Termometresi
Digital Pocket Thermometer
Kod
Code
62060004

- -50+200°C / -58+392°F
- Suya dayanıklı/Waterproof
- S/S Delici Çubuk/Probe :125 mm

- -50+530°C / -58+986°F
- Uzaklık değeri/Distance Ratio : 12/1
- LCD Ekran / LCD Screen



» Kızılötesi Termometre (Lazer Göstergeli)
Infrared Thermometer
Kod
Code
62060005



» Hassas Terazi
Digital Scale

Kod Code	Kapasite Capacity	Hassasiyet Accuracy	Ölçü (cm) Dim. (cm)
65010010	10 Kg	1 g	14,5x14,5



» Hassas Terazi
Digital Scale

Kod Code	Kapasite Capacity	Hassasiyet Accuracy	Ölçü (cm) Dim. (cm)
65010025	25 Kg	1 g	17,5x20

68



» Hassas Terazi
Digital Scale

Kod Code	Kapasite Capacity	Hassasiyet Accuracy	Ölçü (cm) Dim. (cm)
65010015	15 Kg	0,5 g	18x21,5
65010030	30 Kg	1 g	18x21,5



» Hassas Terazi
Digital Scale

Kod Code	Kapasite Capacity	Hassasiyet Accuracy	Ölçü (cm) Dim. (cm)
65010003	3 Kg	0,5-1 g	17,6x22,3



» Mekanik İbrelili Terazi
Mechanical Scale

Kod Code	Kapasite Capacity	Hassasiyet Accuracy
65010020	20 Kg	50 g



» Baskül
Receiving Digital Scale

Kod Code	Kapasite Capacity	Ölçü (cm) Dim. (cm)
65010150	150 Kg	40x50
65010300	300 Kg	60x70



» Ölçülü Mayonez Kabı
Calibrated Mixing Bowl

Kod Code	Øxh (cm) Øxh (cm)
35050016	16x8
35050020	20x10
35050024	24x12
35050030	30x15
35050036	36x18



» Konik Ölçülü Kap
Calibrated Conical Bowl

Kod Code	Øxh (cm) Øxh (cm)
62015020	20
62015024	24
62015028	28
62015032	32
62015036	36
62015040	40
62015045	45



» Çelik Kova Ölçülü
Calibrated Bucket (S/S)

Kod Code	Lt Lt
52020012	12



» Ölçülü Maşrapa
Calibrated Bain-Marie Pot

Kod Code	Øxh (cm) Øxh (cm)
35701416	14x16
35701618	16x18
35701820	18x20
35702022	20x22



» Polikarbonat Ölçme Kabı
PC Measuring Cup

Kod Code	Lt Lt
60021001	1
60021002	2
60021003	3
60021005	5



» Polipropilen Ölçme Kabı
PP Measuring Cup

Kod Code	Lt Lt
43031001	0,5
43031002	1
43031003	2
43031004	3
43031006	5



» Ölçü Kabı
Measuring Cup

Kod Code	Lt Lt
62010001	1
62010002	2



» Dörtlü Ölçme Seti
Measuring Cup Set

Kod Code
40010058
*1/4 - 1/3 - 1/2 - 1/1 Cup



» Dörtlü Ölçü Kaşık Seti
Measuring Spoon Set

Kod Code
40010059
*2,5 cc - 5 cc - 7,5 cc - 15 cc



» Sos Hunisi

Sauce Gun

Kod
Code

62010019

* İki farklı kalınlıkta akıtma ağız seçeneği.
* Includes two interchangeable tips.



» Yumurta Çemberi

Egg Ring

Kod
Code

62010039

Model
Model

Yuvarlak/Round

Ölçü (cm)
Dim. (cm)

Ø 10

62010029

Kare/Square

10x10



» Portatif Mutfak Rafı

Speed Rail

Kod
Code

56032322

Ölçü (cm)
Dim. (cm)

56

56032332

81

70



» Rende Kalın

Grater Coarse

Kod
Code

83100030



» Rende Ekstra Kalın

Grater Extra Coarse

Kod
Code

83100040



» Rende Ribbon

Grater Ribbon

Kod
Code

83100010



» Rende Shaver

Grater Shaver

Kod
Code

83100020



» Rende

Grater

Kod
Code

52020001



» Piramit Rende

Grater

Kod
Code

44013300

Model
Model

Piramit/Pyramid
Endüstriyel/Industrial

44013301



» Sipariş Tutucu (Bilyeli)

Tickets-holder

Kod Code	Ölçü (cm) Dim. (cm)
62010061	61



» Şef Cımbızı

Chef's Tong

Kod Code	Ölçü (mm) Dim. (mm)	Model Model
77502913	145x10	Düz/Straight
77502021	200x25	Belli/Angular
77500025	250	Düz/Straight



» Karıştırıcı Palet (Paslanmaz)

Mixing Spatula (S/S)

Kod Code	Ölçü (cm) Dim. (cm)
62010142	107



» Patates Ezici (Paslanmaz)

Potato Masher (S/S)

Kod Code	Ölçü (cm) Dim. (cm)
62010128	71



» Dekor Kaşık Seti (2'li)

Deco Spoon Set (2 Spoons)

Kod Code	Ø (mm) Ø (mm)	h (mm) h (mm)
77506436	75	55



» Şaşula (Paslanmaz)

Scoop (S/S)

Kod Code	Kapasite (gr) Capacity (gr)
44014301	98
44014302	136
44014303	252
44014304	382
44014305	560



» Düz Şaşula (Polikarbonat)

PC Scoop

Kod Code	Model Model
46010116	Düz/Plain
46010117	Delikli/Perforated

plast|port



» Pataşu (Polietilen)

Spatula (Polyethylene)

Kod Code	Ölçü (cm) Dim. (cm)
49000030	30
49000035	35
49000045	45
49000055	55
49000065	65
49000075	75
49000100	100
49000120	120



» Havan (Polietilen)
Mortar (Polyethylene)

Kod Code	Model Model
49020002	Küçük/Small
49020003	Orta/Medium
49020004	Büyük/Big



» Bal Tokmagı (Polietilen)
Honey Spoon (Polyethylene)

Kod Code
49020010



» Balık Pulu Temizleyicisi (Polietilen)
Fish Scale Cleaner (Polyethylene)

Kod Code
49020020



» Un Elek (Paslanmaz)
Sieve (S/S)

Kod Code	Ø (cm) Ø (cm)
44013025	25
44013030	30
44013040	40



» Kalbur (Paslanmaz)
Grate (S/S)

Kod Code	Ø (cm) Ø (cm)
44013125	25
44013130	30
44013140	40



» Baharat Shaker
Shaker

Kod Code	Ölçü (cm) Dim. (cm)	Model Model
62021789	7	Büyük Delikli Big Hole
62023789	7	Küçük Delikli Small Hole
62022789	7	Süzgeç Mesh

72



» Helvane Süzgeç
Colander

Kod Code	Ø (cm) Ø (cm)
30423609	36x9
30423812	38x12
30424512	45x12
30425012	50x12
30426012	60x14
30427014	70x14
30428016	80x16



» Süzgeç Kaçarola
Colander for Sauce Pan

Kod Code	Ø (cm) Ø (cm)
31380005	20x13
31380006	24x15
31380020	28x17



» Çelik Süzgeç
Colander

Kod Code	Ø (cm) Ø (cm)
62010028	28
62010032	32
62010036	36
62010040	40



Dengeyi kuvvetlendiren 2'li kanca
2 hooks for stability

Güçlü monoblok gövde ve sap
Body and handle made of one- piece composite material

3 kademe sık paslanmaz çelik süzgeç
Triple fine stainless steel triple mesh

Monoblok ergonomik sap
One-piece ergonomic handle

Rahat ve ısı yalıtımlı
Comfortable heat insulating handle

Destekli paslanmaz çelik
Stainless steel wire reinforcement



» Çin Külâhı
Chinese Colander

Kod Code	Ø (cm) Ø (cm)
62010016	16
62010020	20
62010024	24



» Exoglass Konik Sık Süzgeç
Exoglass Bouillon Strainer

Kod Code	Ø (cm) Ø (cm)
77507360	20x22



» Konik Sos Süzgeci Destekli
S/S Bouillon Strainer

Kod Code	Ø (cm) Ø (cm)
62011290	22x23

73



» Konik Süzgeç
Conical Strainer

Kod Code	Ø (cm) Ø (cm)
62013016	16
62014020	20



» Makarna Pişirme Süzgeci
1/4-Segment Pasta Colander

Kod Code	Ölçü (cm) Din. (cm)
36302420	24x19,5 Tencere ile uyumlu Suitable for 24x19,5 Pot
36303623	36x22 Tencere ile uyumlu Suitable for 36x22 Pot
36304026	40x25 Tencere ile uyumlu Suitable for 40x25 Pot



» Huni (Süzgeçli)
Funnel w/Strainer

Kod Code	Ölçü (cm) Din. (cm)
62010475	12
62010550	14



» Derin Kepçe Sık (Paslanmaz)
Round Strainer (S/S)

Kod Code	Ölçü (cm) Dim. (cm)
44013424	24
44013427	27
44013430	30



» Derin Kepçe Seyrek (Paslanmaz)
Coarse Round Strainer (S/S)

Kod Code	Ölçü (cm) Dim. (cm)
44013324	24
44013327	27
44013330	30



» Tel Süzgeç (Paslanmaz)
Round Strainer (S/S)

Kod Code	Ölçü (cm) Dim. (cm)
62010018	18
62010022	22
62010026	26



» Tel Kevgir Sık (Paslanmaz)
Mesh Skimmer (S/S)

Kod Code	Ölçü (cm) Dim. (cm)
44013217	17
44013222	22
44013227	27
44013230	30



» Tel Kevgir Seyrek (Paslanmaz)
Coarse Mesh Skimmer (S/S)

Kod Code	Ölçü (cm) Dim. (cm)
44013817	17
44013822	22
44013827	27
44013830	30

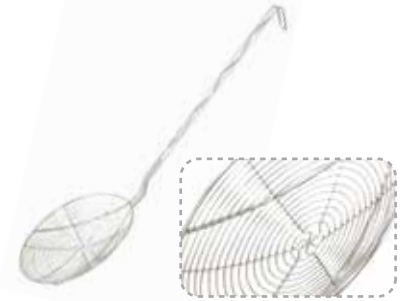

» Kevgir Kalın (Lokma Kevgiri)
Wire Skimmer S/S (Heavy Duty)

Kod Code	Ölçü (cm) Dim. (cm)
62016020	20
62016024	24
62016028	28



» Tencere Teli (Paslanmaz)
Strainer for Pot (S/S)

Kod Code	Ölçü (cm) Dim. (cm)
44013015	30x15
44014020	40x20
44015020	50x20
44016020	60x20
44017030	70x30
44018030	80x30



» Tava Teli (Paslanmaz)
Strainer for Pan (S/S)

Kod Code	Ölçü (cm) Dim. (cm)
44014011	40x11
44015012	50x12
44016014	60x14
44017015	70x15
44018016	80x16





» Askılı Çırpıcı (Paslanmaz)

Wire Whip (S/S)

Kod Code	Ölçü (cm) Dim. (cm)
40010061	25
40010062	30
40010063	35
40010064	40
40010065	45
40010066	50
40010067	55
40010068	60

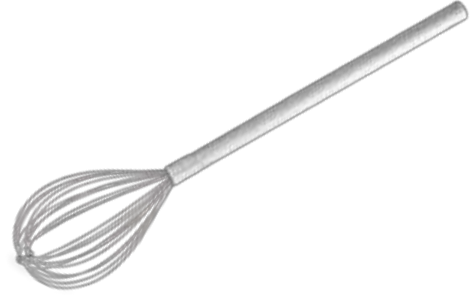

» Çırpma Teli (Krom)

Balloon Whisk (Chrome Plated)

Kod Code	Ölçü (cm) Dim. (cm)
44010274	74
44010298	98
44012120	120



» Çırpıcı

Whisk

Kod Code	Ölçü (cm) Dim. (cm)
62020031	31
62020036	36
62020041	41
62020046	46
62020051	51



» Yumurta Çırpıcı

Egg Whisk

Kod Code	Ölçü (cm) Dim. (cm)
40010071	10
40010072	20



» Piyano Çırpıcı (Paslanmaz)

Whisk (S/S)

Kod Code	Ölçü (cm) Dim. (cm)
40010069	25
40010070	35

Spatulalar / Spatulas



» Exoglass Delikli Yanmaz Spatula

Exoglass Heat-Resistant Spatula

Kod Code	Ölçü (cm) Dim. (cm)
77502430	30



» Exoglass Yanmaz Spatula

Exoglass Heat-Resistant Spatula

Kod Code	Ölçü (cm) Dim. (cm)
77503025	25
77503030	30
77503035	35
77503040	40
77503045	45
77503050	50



» Yanmaz Spatula

Heat-Resistant Spatula

Kod Code	Ölçü (cm) Dim. (cm)
62012500	25
62013500	35
62014500	40

76



» Pasta Spatula

Pastry Spatula

Kod Code	Ölçü (cm) Dim. (cm)
62013025	25
62013030	30
62013035	35



» Belli Pasta Spatula

Angular Spatula

Kod Code	Ölçü (cm) Dim. (cm)
62010025	25



» Spatula

Spatula

Kod Code	Ölçü (cm) Dim. (cm)
62010010	10
62010013	13
62010015	15



» Geniş Spatula

Wide Spatula

Kod Code	Ölçü (cm) Dim. (cm)
62012020	20
62011025	25



» Geniş Spatula Delikli

Perforated Wide Spatula

Kod Code	Ölçü (cm) Dim. (cm)
62012025	25



» Pizza Küreği

Pizza Spatula

Kod Code	Ölçü (cm) Dim. (cm)	Model Model
62010008	17	Normal Plain
62010014	17	Delikli Perforated



» Servis Spatula (Paslanmaz)
Serving Spatula (S/S)

Kod Code	Ölçü (cm) Dim. (cm)
62010011	25



» Spatula (Paslanmaz Saplı)
Spatula (S/S Handle)

Kod Code	Ölçü (cm) Dim. (cm)
44020001	6,5x11
44020002	8x12
44020003	10x13,5
44020004	11x16
44020005	13x17



» Pasta Paleti (Paslanmaz Saplı)
Pastry Spatula (S/S Handle)

Kod Code	Ölçü (cm) Dim. (cm)
44020101	20x3,5
44020102	25x3,5
44020103	30x3,5



» Pasta Bıçağı (Paslanmaz Saplı)
Pastry Knife (S/S Handle)

Kod Code	Ölçü (cm) Dim. (cm)
44020201	20x3,5
44020202	25x3,5
44020203	30x3,5



» Dişli Pasta Bıçağı (Paslanmaz Saplı)
Pastry Knife (S/S Handle)

Kod Code	Ölçü (cm) Dim. (cm)
44020301	20x3,5
44020302	25x3,5
44020303	30x3,4



» Pizza Küreği (Paslanmaz Saplı)
Pizza Spatula (S/S Handle)

Kod Code	Ölçü (cm) Dim. (cm)
44020006	16x4x13,5



» Pizza Ruleti
Pizza Roulette

Kod Code	Ölçü (cm) Dim. (cm)
62010021	10



» Hamur Kazıyıcısı (Paslanmaz Saplı)
Dough Scraper (S/S Handle)

Kod Code	Ölçü (cm) Dim. (cm)
62010006	13x11



490 491 492 493 494 495



» Poliyeten Kesim Levhaları

Cutting Boards

Kod Code	Ölçü (cm) Dim. (cm)
49050404	25x40x4
49030404	30x40x4
49030504	30x50x4
49030604	40x60x4
49025402	25x40x2
49030402	30x40x2
49030502	30x50x2
49063202	32,5x26,5x2
49025302	32,5x53x2
49060402	60x40x2



» Kesim Levhası (GN 1/1 Küvet ile uyumlu)

Cutting Board for GN Pan

Kod Code	Model Model
49020030	GN 1/1-100 Küvet için Cutting Board for GN 1/1 Pan

* GN küvet fiyata dahil değildir.

* w/o G/N Pan.

78

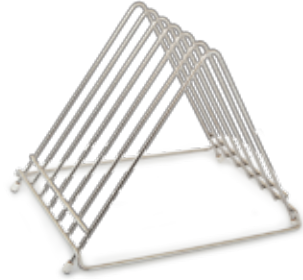

» Kesim Levhası İstif Teli (6 Bölmeli)

Cutting Board Rack S/S (6 Partitioned)

Kod Code	Ölçü (cm) Dim. (cm)
62021885	30,5x26,5x26,5

* 2 cm kalınlığındaki levhalara uygundur.

* Suitable for 2mm cutting board

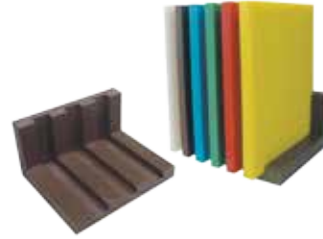

» Poliyeten İstif Rafı

Storing Shelf for Cutting Board

Kod Code	Kalınlık (cm) Thickness (cm)
49000002	2
49000004	4



» Poliyeten Levha Temizleme Bıçağı

Board Scraper (Polyethylene)

Kod Code
49000003





Dövme Şef Bıçakları Forged Chef's Knives

Dövme bıçaklarda kolay kavrama ve ergonomik kullanım sağlayan yüksek kalite plastik (POM) sap kullanılmıştır

The Handle
For the forged cook's knives only high grade POM plastic scales are used



Usta ellerde dövülerek yumuşatılan çelik 8 adımda mükemmelliğe ulaşır. En hassas şekilde bilenen bıçaklarımız mükemmel kesimi garanti eder.

The refinement
In eight steps the knife is smoothed to perfection.
The honing by the hand of a master craftsman guarantees a perfect blade

Yüksek kalitede kromlu molibdenli çelikten (X50 CRMO 14) 9 aşamalı yöntemle üretilir

The forging
From high grade chrome-molybdenum steel (X50 CRMO 14) the forged blank blade is manufactured in mine procedures

80

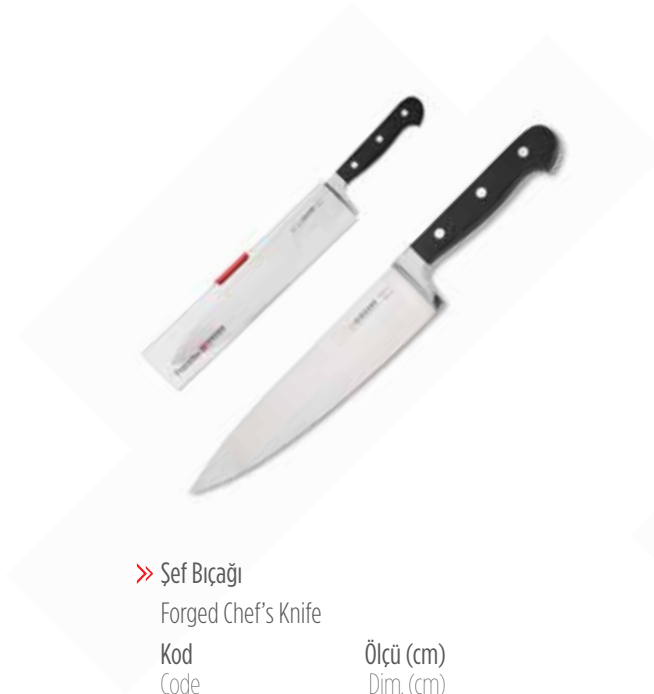

» Şef Bıçağı

Forged Chef's Knife

Kod Code	Ölçü (cm) Dim. (cm)
60501800	18
60502000	20
60502500	25
60503000	30



» Dilimleme Bıçağı

Forged Slicer Knife

Kod Code	Ölçü (cm) Dim. (cm)
60501510	15
60502010	20
60502510	25



» Steak Bıçağı
Forged Steak Knife

Kod Code	Ölçü (cm) Dim. (cm)
60501200	12



» Soyma Bıçağı
Forged Paring Knife

Kod Code	Ölçü (cm) Dim. (cm)
60501000	10



» Kemik Sıyırma Bıçağı
Forged Boning Knife

Kod Code	Ölçü (cm) Dim. (cm)
60501600	16



» Ekmek Bıçağı
Forged Bread Knife

Kod Code	Ölçü (cm) Dim. (cm)
60501610	20



» Fileto Bıçağı
Forged Filleting Knife

Kod Code	Ölçü (cm) Dim. (cm)
60501810	18



» Somon Bıçağı
Forged Salmon Knife

Kod Code	Ölçü (cm) Dim. (cm)
60503100	31

Riveted Chef's Knives Perçinli Şef Bıçakları

Çiftli veya üçlü perçinli ergonomik saplar profesyonel mutfaklarda güvenli kullanım sağlar.

Ergonomics

The double- or triple- rivetted outer or solid material handle provides a safe grip when working in a professional kitchen

Güçlendirilmiş plastikten (POM polioksimetilen) üretilen saplar gıdayla temasa uygundur.

Pom

Polyoxymethylene is a dimensionally stable and rigid plastic that naturally meets the requirements of the Federal Food and Commodities Regulation



» Şef Bıçağı

Chef's Knife

Kod
Code

Ölçü (cm)
Dim. (cm)

60512000

20

60512600

26

82



» Soyma Bıçağı

Paring Knife

Kod
Code

Ölçü (cm)
Dim. (cm)

60518500

8,5



» Çok Amaçlı Bıçak

Multi Purpose Knife

Kod
Code

Ölçü (cm)
Dim. (cm)

60511500

15



» Ekmek Bıçağı

Bread Knife

Kod
Code

Ölçü (cm)
Dim. (cm)

60512400

24



» Kemik Sıyırma Bıçağı

Boning Knife

Kod
Code

Ölçü (cm)
Dim. (cm)

60511510

13



» Kasap Bıçağı

Butcher Knife

Kod
Code

Ölçü (cm)
Dim. (cm)

60512100

21



» Jambon Bıçağı

Ham Knife

Kod
Code

Ölçü (cm)
Dim. (cm)

60512500

25

>> Şef Bıçağı

Chef's Knife

Kod Code	Ölçü (cm) Dim. (cm)
60521600	16
60522000	20
60522300	23
60522600	26
60523100	31



>> Kasap Bıçağı

Butcher Knife

Kod Code	Ölçü (cm) Dim. (cm)
60521800	18
60522100	21
60522400	24
60522700	27
60523000	30



>> Kemik Sıyırma Bıçağı

Boning Knife

Kod Code	Ölçü (cm) Dim. (cm)
60521400	14
60521610	16



>> Dişli Ekmek Bıçağı

Bread Knife Wavy Edge

Kod Code	Ölçü (cm) Dim. (cm)
60521210	21



>> Dişli Belli Ekmek Bıçağı

Bread Knife Wavy Edge Angular

Kod Code	Ölçü (cm) Dim. (cm)
60521230	23

>> Çok Amaçlı Bıçak

Multi Purpose Knife

Kod Code	Ölçü (cm) Dim. (cm)
60522130	13
60522160	16
60522180	18
60522210	21



>> Balık Bıçağı

Fish Knife

Kod Code	Model Model	Ölçü (cm) Dim. (cm)
60522181	Balık/Fish	18
60523210	Balık/Fish	21
60524210	Somon/Salmon	21



>> Miknatslı Bıçaklık

Magnetic Board

Kod Code	Ölçü (cm) Dim. (cm)
60500002	64



>> Bıçak Rulosu

Knife Bag

Kod Code	Model Model
60500001	7 Bölmeli 7 Segments





84



» Şef Bıçağı Monoblok
Cook's Knife Monoblock

Kod Code	Ölçü (cm) Dim. (cm)
44020029	29
44020031	31
44020033	33
44020035	35



» Kaşar Bıçağı Monoblok
Ham Knife Monoblock

Kod Code	Ölçü (cm) Dim. (cm)
44020042	42
44020047	47



» Börek Bıçağı
Pastry & Pie Knife

Kod Code	Ölçü (cm) Dim. (cm)
44020022	22
44020023	23
44020024	24



» Soğan Bıçağı
Onion Knife

Kod Code	Ölçü (cm) Dim. (cm)
44021031	31

* Ölçüler sap hariçtir * Dimensions do not include handles



» Krom Şef Bıçağı
Chrome Cook's Knife

Kod Code	Ölçü (cm) Dim. (cm)
45000026	17
45000027	19
45000028	21



» Sebze Bıçağı
Paring Knife

Kod Code	Ölçü (cm) Dim. (cm)
45091041	9
45091042	12
45091043	13



» Kasap Bıçağı
Butcher Knife

Kod Code	Ölçü (cm) Dim. (cm)
45091000	12,5
45091001	14,5
45091002	16,5
45091003	19
45091004	21
45091008	25



» Ekmek Bıçağı
Bread Knife

Kod Code	Ölçü (cm) Dim. (cm)
45091052	15,5
45091053	17,5



» Kemik Sıyırma Bıçağı
Boning Knife

Kod Code	Ölçü (cm) Dim. (cm)
45091005	12,5
45091006	14,5
45091007	16,5



» Doğrama Bıçağı
Chopping Knife

Kod Code	Ölçü (cm) Dim. (cm)
45000001	14
45000002	16
45000003	18
45000004	20



» Lakerda Bıçağı
Fish Filleting Knife

Kod Code	Ölçü (cm) Dim. (cm)
45091091	25



» Jambon Bıçağı
Ham Knife

Kod Code	Ölçü (cm) Dim. (cm)
45000007	30



» Dişli Ekmek Bıçağı
Bread Knife

Kod Code	Ölçü (cm) Dim. (cm)
45041023	19,5



* Ölçüler sap hariçtir * Dimensions do not include handles



» Şef Bıçağı
Cook's Knife

Kod Code	Ölçü (cm) Dim. (cm)
45091160	19
45091161	21
45091162	23



» Peynir Bıçağı
Cheese Knife

Kod Code	Ölçü (cm) Dim. (cm)
45091070	13,5
45091071	15,5
45091072	17,5



» Döner Bıçağı
Doner Kebab Knife

Kod Code	Ölçü (cm) Dim. (cm)
45071004	55



86



» Baklava Bıçağı
Pastry Knife

Kod Code	Ölçü (cm) Dim. (cm)
45091171	16



» Kaymak Bıçağı
Heavy Cream Knife

Kod Code	Ölçü (cm) Dim. (cm)
45091172	19



» Börek Bıçağı
Pastry & Pie Knife

Kod Code	Ölçü (cm) Dim. (cm)
45071080	16,5
45071082	20



» Balıkçı Bıçağı
Fisher Knife

Kod Code	Ölçü (cm) Dim. (cm)
45091151	35



» Kaşar Bıçağı
Ham Knife

Kod Code	Ölçü (cm) Dim. (cm)
45000005	35



» Kaşar Bıçağı (Çift Saplı)
Ham Knife (Double Handled)

Kod Code	Ölçü (cm) Dim. (cm)
45000006	30

* Ölçüler sap hariçtir * Dimensions do not include handles



» Pizza Bıçağı
Pizza Knife

Kod Code	Ölçü (cm) Dim. (cm)
45071120	26



» Dekor Seti
Decoration Knife Set

Kod Code	Ölçü (cm) Dim. (cm)
45041330	



» Peynir Kesici
Cheese Slicer

Kod Code	Ölçü (cm) Dim. (cm)
62050017	17



» Yuvarlak Masat
Sharpening Steel (Round)

Kod Code	Ölçü (cm) Dim. (cm)
45081083	12



» Yassı Masat
Sharpening Steel

Kod Code	Ölçü (cm) Dim. (cm)
45081088	12



» Et Açma Bıçağı
Filleting Knife

Kod Code	Ölçü (cm) Dim. (cm)
45000030	30
45000035	35

87

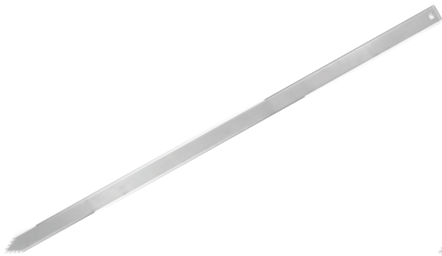

» Yuvarlak Masat
Skewer (S/S)

Kod Code	Ölçü (cm) Dim. (cm)
45081152	60



» Adana Şiş (Galvaniz)
Skewer (Galvanized)

Kod Code	Ölçü (cm) Dim. (cm)
45081153	60

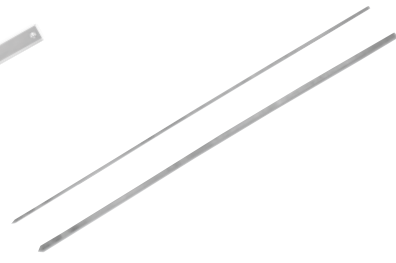

» Kare Şiş (Paslanmaz)
Skewer Square (S/S)

Kod Code	Ölçü (cm) Dim. (cm)
45081167	3x3 mm 60 cm
45081166	5x5 mm 60 cm

* Ölçüler sap hariçtir * Dimensions do not include handles



» Satır
Cleaver

Kod Code	Ölçü (cm) Dim. (cm)
45061111	20
45061112	23



» Uzun Saplı Satır
Cleaver w/Long Handle

Kod Code	Ölçü (cm) Dim. (cm)	No No
45000009	20	1
45000010	24	2
45000011	29	3



» Tavuk Satırı
Poultry Cleaver

Kod Code	Ölçü (cm) Dim. (cm)
45000008	19



» Soğan Satırı
Onion Knife

Kod Code	Ölçü (cm) Dim. (cm)
45061060	19



» Dövme Zırh (Siyah Çelik)
Black Hammered Mincing Knife

Kod Code	Ölçü (cm) Dim. (cm)
45000012	30
45000014	40
45000015	50
45000017	



» Paslanmaz Zırh
Mincing Knife (S/S)

Kod Code	Ölçü (cm) Dim. (cm)
45000018	30
45000020	40
45000022	50

88



» Et Döveceği (Polietilen)
Meat Tenderiser (Polyethylene)

Kod Code	Ölçü (cm) Dim. (cm)
49000005	40



» Et Döveceği (Paslanmaz)
Meat Tenderiser (S/S)

Kod Code
62010017



» Et Döveceği
Meat Tenderiser

Kod Code
45000036



» Çift Saplı Zırh

Mincing Knife w/Double Handles

Kod Code	Ölçü (cm) Dim. (cm)
-------------	------------------------

45000024	25
45000025	30

* Ölçüler sap hariçtir

* Dimensions do not include handles



» Et Çengeli

Meat Hook

Kod Code	Ölçü (cm) Dim. (cm)
-------------	------------------------

62020010	10
62020015	15
62020025	25



» Et Çengeli

Meat Hook

Kod Code	Ölçü (cm) Dim. (cm)	Model Model
-------------	------------------------	----------------

45081040	8	Nikel
		Nikel
45081056	8	Krom
		Chrome



» Çelik Örgü Eldiven

S/S Chainmail Butcher Glove

Kod Code	Ölçü (cm) Dim. (cm)
-------------	------------------------

65600010	Small
65610010	Medium
65620010	Large
65630010	X-Large

* Ters yüz giyilebilir. * Reverse side can be wearable



» Çelik Örgü Uzun Eldiven

S/S Chainmail Shoulder Butcher Glove

Kod Code

65600012



» Kesilmeye Dirençli Eldiven

Cut Resistant Glove

Kod Code

65600011



» Çelik Örgü Önlük

S/S Chainmail Butcher Apron

Kod Code	Ölçü (cm) Dim. (cm)
-------------	------------------------

65605660	55x70<1,65 m
65605670	56x80>1,65 m



» Mıknatıslı Bıçaklık

Magnetic Board

Kod Code	Ölçü (cm) Dim. (cm)
-------------	------------------------

45081205	50
60500002	64



» Bıçak Sterilizatörü

Knife Sterilizer

Kod Code	Model Model
-------------	----------------

45000037 10 Bıçaklı/Division





Pastacılık

Pastry



92 >> Yuvarlak Kalıp Kelepçeli
Springform Mould

Kod Code	Ø (cm) Ø (cm)
64010240	24
64010260	26
64010280	28



>> Yuvarlak Kalıp Kelepçeli
Springform Mould 2 Bottoms

Kod Code	Ø (cm) Ø (cm)
64012400	24
64012800	28



>> Tart Kalıbı Yuvarlak
Round Tart Mould w/Flat Edge (Fluted)

Kod Code	Ø (cm) Ø (cm)	h (mm) h (mm)
64012421	240/210	30
64012623	260/230	30
64012825	280/250	30
64013229	320/290	30



>> Tart Kalıbı Sık Yivli (Çıkarılabilir Taban)
Round Fluted Mould (Loose Bottom, Narrow Ribs)

Kod Code	Ø (cm) Ø (cm)	h (mm) h (mm)
64011080	100/80	30
64011513	150/130	40
64012017	200/170	45
64012521	250/210	50



>> Tart Kalıbı Yuvarlak (Çıkarılabilir Taban)
Medium Deep Fluted Mould (Loose Bottom)

Kod Code	Ø (cm) Ø (cm)	h (mm) h (mm)
64012018	200/185	25
64012423	240/230	25
64012827	280/270	25



>> Yuvarlak Kalıp
Round Plain Mould

Kod Code	Ø (cm) Ø (cm)	h (mm) h (mm)
64012120	200/175	50
64012124	240/210	50
64012528	280/250	50
64013295	320/295	55



» Kare Yivli Tart Kalıbı (Çıkarılabilir Taban)
Square Tartlet Mould (Fluted-Loose Bottom)

Kod Code	Ölçü (mm) Dim. (mm)	h (mm) h (mm)
64011010	100x100	20

» Dikdörtgen Yivli Tart Kalıbı (Çıkarılabilir Taban)
Rectangle Tartlet Mould (Fluted-Loose Bottom)

Kod Code	Ölçü (mm) Dim. (mm)	h (mm) h (mm)
64011275	120x75	20

» Uzun Dikdörtgen Yivli Tart Kalıbı (Çıkarılabilir Taban)
Rectangular Tart Mould (Fluted-Loose Bottom)

Kod Code	Ölçü (mm) Dim. (mm)	h (mm) h (mm)
64113511	350x110	25



» Gondol Kalıp Yivli
Fluted Oval Boat Mould

Kod Code	Ölçü (mm) Dim. (mm)	Ad./Koli Pcs/Ctn
64018040	80x40	12
64011045	100x45	12
64011250	120x50	12

*Ürünlerin satışı koli bazındadır.



» Gondol Kalıp Düz
Plain Oval Boat Mould

Kod Code	Ölçü (mm) Dim. (mm)	Ad./Koli Pcs/Ctn
64016020	60x20	12
64018033	80x33	12
64011043	100x43	12
64011350	120x50	12

*Ürünlerin satışı koli bazındadır.



» Brioche Kalıp
Brioche Mould

Kod Code	Ölçü (mm) Dim. (mm)	Ad./Koli Pcs/Ctn
64016028	60x28	12
64018140	80x40	12
64011055	100x55	12
64011155	110x55	12

*Ürünlerin satışı koli bazındadır.



» Dariole Kalıp
Dariole/Rum Baba Mould

Kod Code	Ø (mm) Ø (mm)	Ad./Koli Pcs/Ctn
64010060	60	12

*Ürünün satışı koli bazındadır.



» Sufle Kalıp
Souffle Mould

Kod Code	Ø (mm) Ø (mm)	Ad./Koli Pcs/Ctn
64010080	80	3

*Ürünün satışı koli bazındadır.



» Yuvarlak Yivli Tart Kalıbı
Fluted Round Canele

Kod Code	Ø (mm) Ø (mm)
64310045	45
64310060	60
64310080	80
64310100	100
64310120	120



» Kubbe Yivli Mini Kalıp
Ribbed Dome Mini Mould

Kod Code	Ölçü (mm) Dim. (mm)
64010045	45



» Oval Yivli Mini Kalıp
Ribbed Oval Mini Mould

Kod Code	Ölçü (mm) Dim. (mm)
64110045	45



» Kare Yivli Mini Kalıp
Ribbed Square Mini Mould

Kod Code	Ölçü (mm) Dim. (mm)
64210045	35x35



» Yuvarlak Derin Mini Kalıp
Deep Plain Round Mini Mould

Kod Code	Ø (mm) Ø (mm)
64010035	35



» Yuvarlak Mini Kalıp
Plain Round Mini Mould

Kod Code	Ø (mm) Ø (mm)
64110035	35



» Dikdörtgen Mini Kalıp
Friand Mould

Kod Code	Ölçü (mm) Dim. (mm)	h (mm) h (mm)
64210035	98x51	14



» Pişirme Tepsisi
Baking Sheet

Kod Code	Ölçü (mm) Dim. (mm)	h (mm) h (mm)
64014035	400x300	35
64014050	400x300	50



» Tost Ekmek Kalıbı
Toastbrot w/Lid

Kod Code	Ölçü (mm) Dim. (mm)
64012500	250x76
64010400	400x90



NEW



NEW



NEW

» Fashion Éclair
Fashion Éclair

Kod Code	Ölçü (mm) Dim. (mm)	Kapasite Capacity
43030093	125x25x25	10x8 ml

» Finger Éclair
Finger Éclair

Kod Code	Ölçü (mm) Dim. (mm)	Kapasite Capacity
43030110	130x27x27	8x9,2 ml

» Pillow
Pillow

Kod Code	Ölçü (mm) Dim. (mm)	Kapasite Capacity
43030100	82x43x32	9x8,2 ml



» Stone
Stone

Kod Code	Ölçü (mm) Dim. (mm)	Kapasite Capacity
43030102	Ø 60x30	8x10,5 ml



» Cacao
Cacao

Kod Code	Ölçü (mm) Dim. (mm)	Kapasite Capacity
43030101	102x57x42	6x19 ml



» Swirl
Swirl

Kod Code	Ölçü (mm) Dim. (mm)	Kapasite Capacity
43030088	Ø 68xh 30	60x400 ml

95



» Mini-Savarin
Mini Savarin

Kod Code	Ölçü (mm) Dim. (mm)	Kapasite Capacity
43030092	Ø 41x12	77x12 ml

NEW



» Mini Kup
Mini Kup

Kod Code	Ölçü (mm) Dim. (mm)	Kapasite Capacity
43030091	25x25x24	88x12 ml

NEW



» Quenelle
Quenelle

Kod Code	Ölçü (mm) Dim. (mm)	Kapasite Capacity
43030064	Ø 70x37	28x100 ml

NEW



» Yarım Küre Mini
Half Sphere Mini

Kod Code	Ölçü (mm) Dim. (mm)	Kapasite Capacity
43030060	Ø 35x17,5	96x11 ml



» Brioche
Brioche

Kod Code	Ölçü (mm) Dim. (mm)	Kapasite Capacity
43030051	Ø 79x35	24x84 ml



» Kalp Mini
Mini Heart

Kod Code	Ölçü (mm) Dim. (mm)	Kapasite Capacity
43030062	36x39x16	70x11 ml

96



» Muffin Büyük
Muffin Big

Kod Code	Ölçü (mm) Dim. (mm)	Kapasite Capacity
43030096	73x40	24x125 ml



» Muffin Mini
Muffin Mini

Kod Code	Ölçü (mm) Dim. (mm)	Kapasite Capacity
43030055	51x29	40x45 ml



» Muffin
Muffin

Kod Code	Ölçü (mm) Dim. (mm)	Kapasite Capacity
43030067	40x20	48x25 ml



» Oval Mini
Oval Mini

Kod Code	Ölçü (mm) Dim. (mm)	Kapasite Capacity
43030068	52x32x20	50x25 ml



» Fiorentin Disk
Fiorentin Disk

Kod Code	Ölçü (mm) Dim. (mm)	Kapasite Capacity
43030053	60x12	35x33,5 ml



» Madlen Mini
Madlen Mini

Kod Code	Ölçü (mm) Dim. (mm)	Kapasite Capacity
43030061	45x26	100x12 ml



» Oval Mini
Oval Mini

Kod Code	Ölçü (mm) Dim. (mm)	Kapasite Capacity
43030068	52x32x20	50x25 ml



» Fiorentin Disk
Fiorentin Disk

Kod Code	Ölçü (mm) Dim. (mm)	Kapasite Capacity
43030053	60x12	35x33,5 ml



» Madlen Mini
Madlen Mini

Kod Code	Ölçü (mm) Dim. (mm)	Kapasite Capacity
43030061	45x26	100x12 ml



» Dörtgen Mini
Square Mini

Kod Code	Ölçü (mm) Dim. (mm)	Kapasite Capacity
43030054	86x46x25	25x110 ml



» Piramit
Pyramid

Kod Code	Ölçü (mm) Dim. (mm)	Kapasite Capacity
43030058	65x35	35x61 ml



» Mekik
Mekik

Kod Code	Ölçü (mm) Dim. (mm)	Kapasite Capacity
43030066	107x45x15	30x35 ml

97



» Kalp
Heart

Kod Code	Ölçü (mm) Dim. (mm)	Kapasite Capacity
43030094	82x90x50	20x130 ml



» Sufle
Souffle

Kod Code	Ölçü (mm) Dim. (mm)	Kapasite Capacity
43030080	44x28	40x28 ml



» Elips Sticks
Elips Sticks

Kod Code	Ölçü (mm) Dim. (mm)	Kapasite Capacity
43030189	495x40	5x450 ml



» Yarım Küre 5'li
Half Sphere 5 Pcs.

Kod Code	Øxh (mm) Øxh (mm)	Kapasite (ml) Capacity (ml)
43030012	80x40	5x120 ml



» Yarım Küre 6'lı
Half Sphere 6 Pcs.

Kod Code	Øxh (mm) Øxh (mm)	Kapasite (ml) Capacity (ml)
43030013	70x35	6x80 ml



» Yarım Küre 6'lı
Half Sphere 6 Pcs.

Kod Code	Øxh (mm) Øxh (mm)	Kapasite (ml) Capacity (ml)
43030014	60x30	6x80 ml



» Yarım Küre 8'li
Half Sphere 8 Pcs.

Kod Code	Øxh (mm) Øxh (mm)	Kapasite (ml) Capacity (ml)
43030015	50x25	8x30 ml



» Yarım Küre 15'li
Half Sphere 15 Pcs.

Kod Code	Øxh (mm) Øxh (mm)	Kapasite (ml) Capacity (ml)
43030016	40x20	15x20 ml



» Yarım Küre 24'ü
Half Sphere 24 Pcs.

Kod Code	Øxh (mm) Øxh (mm)	Kapasite (ml) Capacity (ml)
43030017	30x15	24x10 ml



» Piramit 6'lı
Pyramid 6 Pcs.

Kod Code	Øxh (mm) Øxh (mm)	Kapasite (ml) Capacity (ml)
43030018	71x71	6x90 ml



» Tartalet 15'li
Tartalette 15 Pcs.

Kod Code	Øxh (mm) Øxh (mm)	Kapasite (ml) Capacity (ml)
43030019	50x15	15x25 ml



» Oval 16'li
Oval 16 Pcs.

Kod Code	Øxh (mm) Øxh (mm)	Kapasite (ml) Capacity (ml)
43030020	55x33x20	16x30 ml



» Muffin Mini 11'li
Muffin Mini 11 Pcs.

Kod Code	Øxh (mm) Øxh (mm)	Kapasite (ml) Capacity (ml)
43030021	51x28	11x50 ml



» Muffin Orta 6'lı
Medium Muffin 6 Pcs.

Kod Code	Øxh (mm) Øxh (mm)	Kapasite (ml) Capacity (ml)
43030022	69x35	6x100 ml



» Muffin Büyük 6'lı
Big Muffin 6 Pcs.

Kod Code	Øxh (mm) Øxh (mm)	Kapasite (ml) Capacity (ml)
43030023	68x38	6x119 ml



» Kalp Büyük 6'lı
Big Heart 6 Pcs.

Kod Code	Øxh (mm) Øxh (mm)	Kapasite (ml) Capacity (ml)
43030027	65x40	6x130 ml



» Mekik Orta 12'li
Medium Boat 12 Pcs.

Kod Code	Øxh (mm) Øxh (mm)	Kapasite (ml) Capacity (ml)
43030028	72x30	12x20 ml



» Mekik Büyük 9'lu
Big Boat 9 Pcs.

Kod Code	Øxh (mm) Øxh (mm)	Kapasite (ml) Capacity (ml)
43030029	100x44	9x40 ml



» Petit Four 15'li
Petit Four 15 Pcs.

Kod Code	Øxh (mm) Øxh (mm)	Kapasite (ml) Capacity (ml)
43030025	40x20	15x30 ml



» Brioche 6'lı
Brioche 6 Pcs.

Kod Code	Øxh (mm) Øxh (mm)	Kapasite (ml) Capacity (ml)
43030026	79x37	6x110 ml



» Kalp Orta 8'li
Medium Heart 8 Pcs.

Kod Code	Øxh (mm) Øxh (mm)	Kapasite (ml) Capacity (ml)
43030071	60x35	8x90 ml



» Vertigo 6'li
Vertigo 6 Pcs.

Kod Code	Øxh (mm) Øxh (mm)	Kapasite (ml) Capacity (ml)
43030033	77x37	6x110 ml



» Tartalet 8'li
Tartlette 8 Pcs.

Kod Code	Øxh (mm) Øxh (mm)	Kapasite (ml) Capacity (ml)
43030031	60x17	8x42 ml



» Kalp Küçük 10'lu
Small Heart 10 Pcs.

Kod Code	Øxh (mm) Øxh (mm)	Kapasite (ml) Capacity (ml)
43030032	48x54	10x45 ml



» Ceviz Küçük 15'li
Small Nut 15 Pcs.

Kod Code	Øxh (mm) Øxh (mm)	Kapasite (ml) Capacity (ml)
43030036	41x30	15x21 ml



» Gül Mini 15'li
Mini Rose 15 Pcs.

Kod Code	Øxh (mm) Øxh (mm)	Kapasite (ml) Capacity (ml)
43030034	44x27	15x23 ml



» Gül 15'li
Rose 15 Pcs.

Kod Code	Øxh (mm) Øxh (mm)	Kapasite (ml) Capacity (ml)
43030035	44x27	15x23 ml



» Ceviz Büyük 8'li
Big Nut 8 Pcs.

Kod Code	Øxh (mm) Øxh (mm)	Kapasite (ml) Capacity (ml)
43030037	76x48	8x44 ml

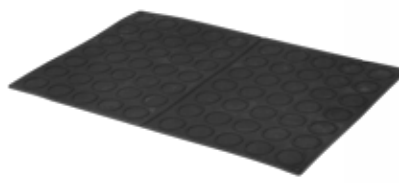

» Macaron Silpatı
Macaron Baking Sheet

Kod Code	Øxh (mm) Øxh (mm)	Kapasite (ml) Capacity (ml)
43035000	40x60	70 bölme 70 partition



» Fiber Örtü Silpat
Baking Sheet

Kod Code	Ölçü (cm) Dim. (cm)
43030069	40x60



» Kaşık Çikolata Kalıbı
Spoon Chocolate Mould

Kod Code	Ölçü (mm) Dim. (mm)	Kapasite Capacity
43032002	275x135	10x20 gr



» Kare Sargılı Çikolata Kalıbı
Square Chocolate Mould

Kod Code	Ölçü (mm) Dim. (mm)	Kapasite Capacity
43032002	275x135	10x20 gr



» Çizgili Elips Çikolata Kalıbı
Rib Oval Chocolate Mould

Kod Code	Ölçü (mm) Dim. (mm)	Kapasite Capacity
43032003	275x135	24x15 gr



» Elmas Çikolata Kalıbı
Diamonds Chocolate Mould

Kod Code	Ölçü (mm) Dim. (mm)	Kapasite Capacity
43032004	275x135	21x14 gr



» Çelenk Çikolata Kalıbı
Wreath Chocolate Mould

Kod Code	Ölçü (mm) Dim. (mm)	Kapasite Capacity
43032004	275x135	21x10 gr



» Çikolatin Kalıbı
Roses Chocolate Mould

Kod Code	Ölçü (mm) Dim. (mm)	Kapasite Capacity
43032004	275x135	24x8 gr

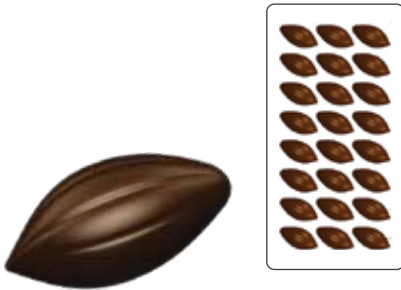

» Kakao Çikolata Kalıbı
Cacao Chocolate Mould

Kod Code	Ölçü (mm) Dim. (mm)	Kapasite Capacity
43032007	275x135	24x10 gr



» Ceviz Çikolata Kalıbı
Walnut Chocolate Mould

Kod Code	Ölçü (mm) Dim. (mm)	Kapasite Capacity
43032008	275x135	24x8 gr

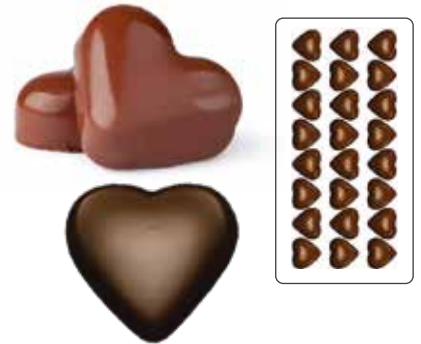

» Bombeli Kalp Çikolata Kalıbı
Heart Chocolate Mould

Kod Code	Ölçü (mm) Dim. (mm)	Kapasite Capacity
43032009	275x135	24x13 gr

Çikolata Kalıpları / Chocolate Moulds



» Büyük Kestane Çikolata Kalıbı
Big Chocolate Mould

Kod Code	Ölçü (mm) Dim. (cm)	Kapasite Capacity
43032010	275x135	21x13 gr



» Küçük Kestane Çikolata Kalıbı
Small Scallop Chocolate Mould

Kod Code	Ölçü (mm) Dim. (cm)	Kapasite Capacity
43032012	275x135	24x13 gr

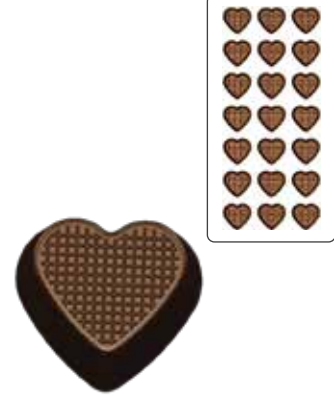

» Ekose Kalp Çikolata Kalıbı
Patterned Heart Chocolate Mould

Kod Code	Ölçü (mm) Dim. (cm)	Kapasite Capacity
43032011	275x135	21x11 gr

102

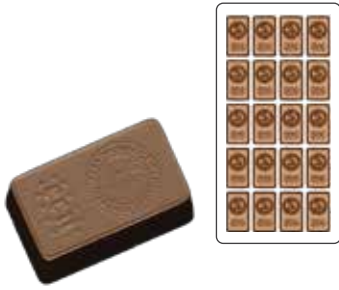

» Altın Külçe Çikolata Kalıbı
Gold Ingot Chocolate Mould

Kod Code	Ölçü (mm) Dim. (cm)	Kapasite Capacity
43032013	275x135	20x17 gr



» Taç Çikolata Kalıbı
Crown Chocolate Mould

Kod Code	Ölçü (mm) Dim. (cm)	Kapasite Capacity
43032014	275x135	24x14 gr



» Kelebek Çikolata Kalıbı
Butterfly Chocolate Mould

Kod Code	Ölçü (mm) Dim. (cm)	Kapasite Capacity
43032015	275x135	21x10 gr



» Etekli Elips Çikolata Kalıbı
Ribbed Elips Chocolate Mould

Kod Code	Ölçü (mm) Dim. (cm)	Kapasite Capacity
43032016	275x135	24x13 gr



» Küp Çikolata Kalıbı
Cubic Chocolate Mould

Kod Code	Ölçü (mm) Dim. (cm)	Kapasite Capacity
43032017	275x135	24x12,5 gr

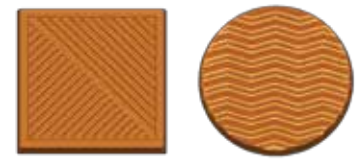

» Madlen Çikolata Kalıbı
Cubic Chocolate Mould

Kod Code	Ölçü (mm) Dim. (cm)	Model Model
43032019	43x43x6 gr	Yuvarlak Round
43032020	40x40x 6 gr	Kare Square

- Şoka dayanıklı Polipropilen gövde
- Sökülebilir paslanmaz çelik iç hazne
- Çikolatayı eritir ve sıvı halde kalmasını sağlar
- Özel rezistansı sayesinde homojen ısı dağılımı
- 25-90°C ısı aralığı
- Yalıtımlı gövde maksimum enerji tasarrufu sağlar
- Ağırlık : 1,8 Kg

- Multi-Purpose appliance for melting and keeping chocolate, fondant, toppings, sauces, jelly, etc.
- Non detachable stainless steel bowl
- Heat is uniformly distributed thanks to a special resistor
- Electronic regulation 25 to 90°C for a wide range of uses. Accuracy $\pm 1,5^\circ\text{C}$
- Reduced energy consumption thanks to efficient insulation
- Weight: 1.8 kg



» Yuvarlak Çikolata Eritme Makinesi

Chocolate Melting Machine

Kod Code	Øxh (mm) Øxh (mm)	Kapasite Capacity
77550010	254x188	3,5 Lt

NEW



» Çikolata Firkete Takımı

Chocolate Dipping Forks

Kod Code	Model Model
43230010	10'lü/10 pcs

NEW

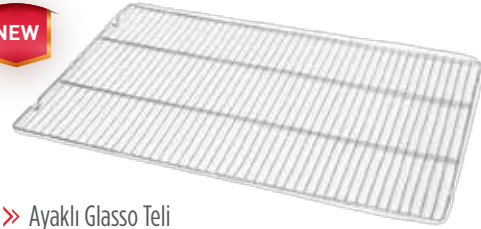

» Ayaklı Glasso Teli

Cooling Rack

Kod Code	Ölçü(cm) Dims.(cm)
43034060	40x60

103



» Çikolata Püskürtme Makinası

Chocolate Spray Gun

Kod Code
43031050



» Çikolata Spatulası

Çikolata Spatulası

Kod Code	Ölçü (cm) Dim. (cm)
43031051	20

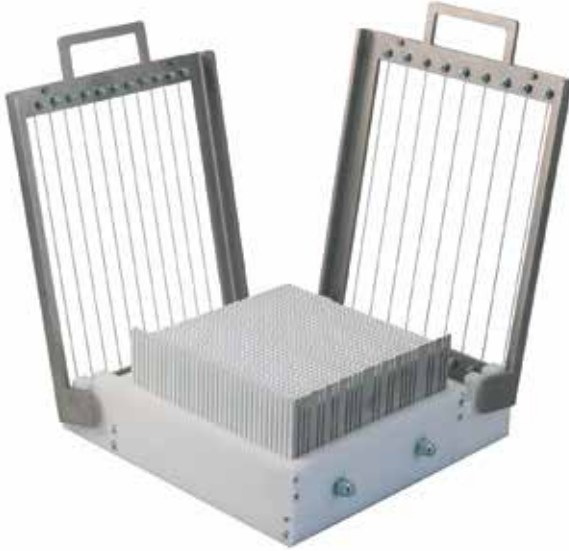
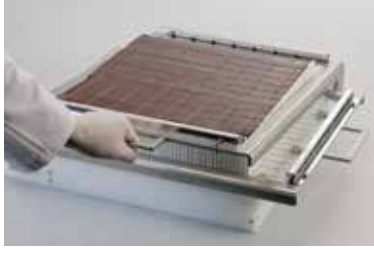

- Çikolatalar, karameller, kanepeler, meyve jöleleri vs. tarzı ürünler için hızlı ve muntazam kesim sağlar
- Gitarın çiftli kolları sayesinde ürün tepsisini çevirmeye gerek yok, zaman tasarrufu ve muntazam kesim
- 5 farklı dörtgen ölçüde kesim seçeneği : 15x22,5; 15x30; 15x45; 22,5x30; 30x45 mm
- 3 farklı kare ölçüde kesim seçeneği : 22,5x22,5; 30x30; 45x45 mm
- Her ihtiyaca göre farklı kesim kolu seçebilme
- 15 mm kesim kolu sadece cephe kesiminde kullanılır
- Kesim kolları kolayca değiştirilebilir, herhangi bir alete ihtiyaç yoktur
- 425x425 mm paslanmaz çelik plaka ile desteklenmiş ana gövde bulaşık makinasında yıkanabilir
- Tellerin gerginliğini ayarlama anahtarı ve 3 adet yedek tel ile beraber gelir



104

Gitar Çiftli Dilimleme Makinası
Double Guitar

Kod Code	Ölçü (mm) Dim. (mm)	Model Model
	500x500x160	Gövde/ Base
77503540	15	Kesici Kol/ Cutting Arm
77503542	22,5	Kesici Kol/ Cutting Arm
77503543	30	Kesici Kol/ Cutting Arm
77503544	45	Kesici Kol/ Cutting Arm
77503545	700	Paslanmaz Çelik Tel/ Spare S/S Strings
77503512		



- For fast, regular wire-cutting of the interiors of chocolates, caramels, canapés, fruit jellies, etc.
- The double guitar avoids having to turn the product trays for cutting: time saving and improved cutting precision
- Cuts into 5 different rectangle sizes: 15 x 22.5; 15 x 30; 15 x 45; 22.5 x 30; 30 x 45mm
- 3 square sizes: 22.5 x 22.5; 30 x 30 and 45 x 45mm
- Cutting arm to order according to the needs of each user. 2 arms required (imperative)
- The 15mm cutting arm can only be used for frontal cutting
- Cutting arms easily interchangeable, no tools required
- Dishwasher-safe base, supplied with a stainless steel plate 425 x 425 mm
- wire tensioning key and 3 spare wires



» Çember h: 5 cm
Cake Rings h:5 cm

Kod Code	Ø (cm) Ø (cm)
43030508	8
43030510	10
43030514	14
43030516	16
43030518	18
43030520	20
43030522	22
43030524	24
43030526	26
43030528	28



» Çember h: 7 cm
Cake Rings h:7 cm

Kod Code	Ø (cm) Ø (cm)
43030708	8
43030710	10
43030714	14
43030716	16
43030718	18
43030720	20
43030722	22
43030724	24
43030726	26
43030728	28



» Ayarlı Çember (Çelik)
Adjustable Ring

Kod Code	Ölçü (cm) Dim. (cm)
43030010	15-30



» Kare Kalıp h: 7 cm
Square Rings h: 7 cm

Kod Code	Ölçü (cm) Dim. (cm)
43031710	10x10
43031713	13x13
43031715	15x15
43031717	17x17
43031719	19x19
43031722	22x22
43031724	24x24
43031726	26x26
43031728	28x28
43031730	30x30



» Kare Kalıp h: 10 cm
Square Rings h: 10 cm

Kod Code	Ölçü (cm) Dim. (cm)
43031010	10x10
43031013	13x13
43031015	15x15
43031017	17x17
43031019	19x19
43031022	22x22
43031024	24x24
43031026	26x26
43031028	28x28
43031030	30x30



» Ayarlı Dörtgen Kalıp (Çelik)
Adjustable Cake Mould

Kod Code	Ölçü (cm) Dim. (cm)
43030007	20-40
43030006	30-60
43030009	20-40
43030008	30-60



» Tart Çemberi (Kıvrık Kenarlı)
S/S Tart Ring Rolled Edges

Kod Code	Ölçü (cm) Dim. (cm)	Koli/Adet Ctn/Pcs
77507016	70x16	6
77508016	80x16	6
77509016	90x16	6
77501020	100x20	6

*Ürün satışı 6'lı paketler halindedir.



» Tart Çemberi (Kıvrık Kenarlı)
S/S Tart Ring Rolled Edges

Kod Code	Ölçü (cm) Dim. (cm)
77501220	120x20
77501420	140x20
77501620	160x20
77501820	180x20
77502020	200x20
77502220	220x20
77502420	240x20
77502620	260x20
77502820	280x20
77503020	300x20
77503220	320x20



106

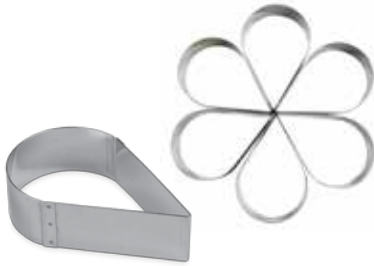

» Su Damlası Kalıp
Waterdrop

Kod Code	Ölçü (mm) Dim. (mm)	h (mm) h (mm)
64019060	90x60	30
64012817	280x175	45



» Kalp Kalıp
Convex Heart

Kod Code	Ölçü (mm) Dim. (mm)	h (mm) h (mm)
64018585	85x85	30



» Bombeli Kare Kalıp
Convex Heart

Kod Code	Ölçü (mm) Dim. (mm)	h (mm) h (mm)
64016060	60x60	30



» Oblong Kalıp
Oblong

Kod Code	Ölçü (mm) Dim. (mm)	h (mm) h (mm)
64011140	110x40	110x40



» Gözyaşı Damlası Kalıp
Teardrop

Kod Code	Ölçü (mm) Dim. (mm)	h (mm) h (mm)
64019050	90x50	30



» Ayarlı Kalp Kalıp (Çelik)
Adjustable Heart Mould

Kod Code	h (mm) h (mm)	Koli/Adet Ctn/Pcs
43030011	7	12



» Yuvarlak Kopat
Round Cutter

Kod Code	Ölçü (mm) Dim. (mm)	Ölçü (mm) Dim. (mm)
43032000	Dişli/Fluted	35-95
43132000	Düz/Plain	



» Yuvarlak Metal Volovan
Round Cutter Steel

Kod Code	Ölçü (mm) Dim. (mm)
43030105	Dişli/Fluted
43030104	Düz/Plain



» Kare Metal Volovan
Square Cutter Steel

Kod Code	Ölçü (mm) Dim. (mm)
43030107	Dişli/Fluted
43030106	Düz/Plain



» Ayarlı Rulet Çift Taraflı
Dough Wheel Multi Cut

Kod Code	Model Model
43030049	5'li 5 Wheels
43030050	7'li 7 Wheels



» Kafes Kesici Rulet
Pastry Roller

Kod Code
77501110



» Delici Rulet
Spiked Pastry Roller

Kod Code
77501120



» Tekstil Eldiven
Oven Mitt

Kod Code	Ölçü (cm) Dim. (cm)
43130005	Kısa Short
43130006	Uzun Long



» Yanmaz Eldiven
Leather Glove (Over Wrist)

Kod Code
43030005



» Silikon Eldiven Uzun
Silicone Glove (Textile Over Wrist)

Kod Code
43130004

NEW



» Soda Sifonu
Soda Siphon



Kod Code	Kapasite Capacity
43130045	1,0 Lt
43130047	10x8 gr Soda Tüpü 10x8 gr Soda Charger

* 1 soda tüpü ile 1 litreye kadar soda hazırlanabilir.
* One soda charger will prepare up to 1 litre of soda water.

108



» Kabartma Kabı
Cream Whipper

Kod Code	Kapasite Capacity
43030045	0,5 Lt
43030046	1,0 Lt
43030047	10x8 gr Kabartma Tüpü 10x8 gr Cream Charger

* 1 kabartma tüpü ile 0,5 litreye kadar krema ve benzeri ürünler hazırlanabilir.
* One cream charger whips up to 0.5 litres of liquid whipping cream or similar product.



» 12'li Duy Seti
Icing Tip Set 12 Ocs.

Kod Code	
43030072	Plastic
43030073	PC



» 26'li Duy Seti (Paslanmaz Çelik)
Icing Tip Set 26 Ocs. (S/S)

Kod Code
43031007



» 52'li Duy Seti (Paslanmaz Çelik)
Icing Tip Set 52 Ocs. (S/S)

Kod Code
43031008



» Büyük Boy Duy Seti 36'lı (S/S)
Icing Tip Big Set 36 Ocs.(S/S)

Kod Code
43031009



» Krema Torbası
Pastry Bag



Kod Code	Ölçü (cm) Dim. (cm)
43030038	40
43030039	46
43030040	50
43030041	55
43030042	60
43030043	65



» Krema Torbası Tek Kullanımlık
Pastry Bag 100 Pcs.

Kod Code	Ölçü (cm) Dim. (cm)	Model Model
43030044	55	72'li 72 Pieces

109



» Pürmüz
Torch

Kod Code
43030048



» Sos Hunisi
Sauce Gun

Kod Code
62010019



» Kakao/Pudra Şekeri Shaker
Shaker

Kod Code	Model Model
62021789	Büyük Delikli 7 cm
62023789	Bih Hole 7 cm
62022789	Küçük Delikli 7 cm
	Small Hole 7 cm
	Süzgeç 7 cm
	Mesh 7 cm



» Spatula Termometre
Spatula Thermometer

Kod Code	Ölçü (cm) Dim. (cm)
77503090	38,5



» Şeker Termometresi
Sugar Thermometer

Kod Code
62060003



» Ekmek Jileti
Disposable Baker's Blade

Kod Code	Ölçü (cm) Dim. (cm)
43131000	14x4



» Kruvasan Mordane
Croissant Roller Cutter

Kod Code	Ölçü (cm) Dim. (cm)
49270430	43x8



» Mordane (Paslanmaz)
Roller (S/S)

Kod Code	Ölçü (cm) Dim. (cm)
44020007	50



» Pandispanya Testeresi
Genoese Saw

Kod Code	Model Model
43031052	2 Testere Set of 2 Spared Blades



» Oklava (Polietilen)
Rollin Pin (Polyethylene)

Kod Code	Ölçü (cm) Dim. (cm)
49020025	Ø 25
49010035	Ø 35



» Saplı Mordane (Polietilen)
Roller (Polyethylene)

Kod Code	Ölçü (cm) Dim. (cm)	Model Model
49070250	Ø 7x25+20	Küçük Small
49080330	Ø 8x33+20	Orta Medium
49098380	Ø 9x38+20	Büyük Big



» Poli Mordane
Poli Roller

Kod Code	Ölçü (cm) Dim. (cm)
49170230	23
49170330	33
49170500	50



» Fırça
Brush

Kod Code	No No
43600001	1
43600002	2
43600003	3



» Sos/Şurup Dökücü
Pouring Container

Kod Code	Lt Lt
60020001	1
60020002	2



» B0 Şurupluk
B0

Kod Code	ml ml
43030075	500
43030076	1000



» Ölçülü Maşrapa
Calibrated Bain-Marie Pot

Kod Code	Øxh (cm) Øxh (cm)
35701416	14x16
35701618	16x18
35701820	18x20
35702022	20x22



» Polikarbonat Ölçme Kabı
PC Measuring Cup

Kod Code	Lt Lt
60021001	1
60021002	2
60021003	3
60021005	5



» Polipropilen Ölçme Kabı
PC Measuring Cup

Kod Code	Lt Lt
43031001	0,5
43031002	1
43031003	2
43031004	3
43031006	5



» Ölçü Kabı
Measuring Cup

Kod Code	Lt Lt
62010001	1
62010002	2



» Dörtlü Ölçek Seti
Measuring Cup Set

Kod Code
40010058
*1/4 - 1/3 - 1/2 - 1/1 Cup



» Dörtlü Ölçü Kaşık Seti
Measuring Spoon Set

Kod Code
40010059
*2,5 cc - 5 cc - 7,5 cc - 15 cc



Pasta Standı
» Cake Stand

Kod Code	Øxh (cm) Øxh (cm)
32502205	22x5
32502405	24x5
32503005	30x5
32503605	36x5
32502210	22x10
32502410	24x10
32503010	30x10
32503610	36x10



» Döner Stand Paslanmaz Çelik
Revolving Cake Stand (S/S)

Kod Code	Øxh (cm) Øxh (cm)
43031005	33



» Döner Stand
Revolving Cake Stand





Kod Code	Øxh (cm) Øxh (cm)
43030074	33



» Pasta / Kek Fanusu
Cake stand

Kod Code	Ölçü (cm) Dim. (cm)	Model Model
80010005	30,5x30,5x11,5	Yuvarlak Round
80010007	39x16,5x12,5	Baton Rectangular

» Kırılmaz Tepsi
Cake stand

Kod Code	Ölçü (cm) Dim. (cm)	Koli/Ad. Pcs/Ctn	
430	431	432	433
Şeffaf	Beyaz	Siyah	Kırmızı
Transparent	White	Black	Red
			
43030030	10x30	100	
43031530	15x30	50	
43032030	20x30	50	
43032540	25x40	50	

» Alüminyum Baklava Tepsileri
Aluminum Confectionary Trays

Kod Code	Ölçü (cm) Dim. (cm)
43013040	30x40x4
43013345	33x45x4
43013545	35x45x4
43013547	35x47x4
43013851	38x51x4
43014050	40x50x4
43014060	40x60x4
43014061	40x60x1,5
43014062	40x60x2
43013480	34x80x2
43013484	34x84x2
43013488	34x88x2
43013080	30x80x5
43023488	34x88x5



NEW



» Hamur Kazıyıcısı Plastik Büyük
Dough Scraper Plastic Big

Kod Code	Ölçü (cm) Dim. (cm)
62110006	15,5x9

NEW



» Hamur Kazıyıcısı
Dough Scraper

Kod Code	Model Model
62110007	Küçük 4'lü set Small 4 pcs set



» Hamur Kazıyıcısı (Paslanmaz Saplı)
Dough Scraper (S/S Handle)

Kod Code	Ölçü (cm) Dim. (cm)
62010006	13x11

Spatulalar / Spatulas



» Exoglass Delikli Spatula
Exoglass Heat Resistant Spatula

Kod Code	Ölçü (cm) Dim. (cm)
77502430	30



» Exoglass Spatula
Exoglass Heat Resistant Spatula

Kod Code	Ölçü (cm) Dim. (cm)
77503025	25
77503030	30
77503035	35
77503040	40
77503045	45
77503050	50



» Kauçuk Spatula
Heat-Resistant Spatula

Kod Code	Ölçü (cm) Dim. (cm)
62012500	25
62013500	35
62014500	40

114



» Pasta Spatula
Pastry Spatula

Kod Code	Ölçü (cm) Dim. (cm)
62013025	25
62013030	30
62013035	35



» Belli Pasta Spatula
Angular Spatula

Kod Code	Ölçü (cm) Dim. (cm)
62010025	25



» Spatula
Spatula

Kod Code	Ölçü (cm) Dim. (cm)
62010010	10
62010013	13
62010015	15



» Geniş Spatula
Wide Spatula

Kod Code	Ölçü (cm) Dim. (cm)
62012020	20
62011025	25



» Geniş Spatula Delikli
Perforated Wide Spatula

Kod Code	Ölçü (cm) Dim. (cm)
62012025	25



» Pizza Küreği
Pizza Spatula

Kod Code	Ölçü (cm) Dim. (cm)	Ölçü (cm) Dim. (cm)
62010008	17	Normal
62010014	17	Normal
		Delikli Perforated



» Servis Spatula (Paslanmaz)

Serving Spatula (S/S)

Kod Code	Ölçü (cm) Dim. (cm)
62010011	25



» Spatula (Paslanmaz Saplı)

Spatula (S/S Handle)

Kod Code	Ölçü (cm) Dim. (cm)
44020001	6,5x11
44020002	8x12
44020003	10x13,5
44020004	11x16
44020005	13x17



» Pasta Paleti (Paslanmaz Saplı)

Pastry Spatula (S/S Handle)

Kod Code	Ölçü (cm) Dim. (cm)
44020101	20x3,5
44020102	25x3,5
44020103	30x3,5



» Pasta Bıçağı (Paslanmaz Saplı)

Pastry Knife (S/S Handle)

Kod Code	Ölçü (cm) Dim. (cm)
44020201	20x3,5
44020202	25x3,5
44020203	30x3,5



» Dişli Pasta Bıçağı (Paslanmaz Saplı)

Pastry Knife (S/S Handle)

Kod Code	Ölçü (cm) Dim. (cm)
44020301	20x3,5
44020302	25x3,5
44020303	30x3,4

115



» Pizza Küreği (Paslanmaz Saplı)

Pizza Spatula (S/S Handle)

Kod Code	Ölçü (cm) Dim. (cm)
44020006	16x4x13,5



» Pizza Ruleti

Pizza Roulette

Kod Code	Ø (cm) Ø (cm)
62010021	10



» Plastik Silistre (Baklava Spatulası)

Plastic Spatula

Kod Code
62110008





Servis

Serving





» PC Kırılmaz Şeffaf Tepsi

PC Unbreakable Transparent Tray

Kod Code	Ölçü (mm) Dim. (mm)	Model Model
39011110	53x32,5x7	GN 1/1



118

Kırılmaz tepşiler catering ve servis endüstrisinin ihtiyaçlarını karşılamak üzere dizayn edilmiştir. Açık büfe sunumlarını sergilemek için pek çok değişik dizilime imkan verecek şekilde tasarlanmıştır. Tepşileri 180° derecelik açıyla kolayca ters çevirip yerleştirerek farklı yüksekliklerde yerleştirebilirsiniz. Tepşilerin ara yüksekliklerini değiştirebilme imkanı farklı yüksekliklerdeki sunumları sergileme imkanı sağlar. Tepsi kenarlarındaki oluklar sayesinde istiflenebilir, üst üste dizilebilir. Bu düzen servis esnasında yer tasarrufu sağlarken aynı zamanda çok şık bir görsel sunum oluşturmaktadır. GN 1/1 ölçüsünde olduğundan Thermoboxlarla uyumludur

Unbreakable tray designed for catering use. Designed to meet the requirements of the catering and service industry. Allowing a multitude of possibilities for stacking that facilitates display and creativity. The decentralized lateral support, allows for varying depth height of the tray with a simple 180° flip. Allowing for a multi-layer display using multiple stacked trays. This overlapping arrangement maximizes internal space to accommodate finger food glasses of differing heights. This overlapping arrangement maximizes internal space to accommodate finger food glasses of differing heights. The sides allow storage in cupboards, and trolleys; as well as transport using the Thermobox thermal containers



» PC Kırılmaz Siyah Tepsi

PC Unbreakable Black Tray

Kod Code	Ölçü (mm) Dim. (mm)	Model Model
39111110	53x32,5x7	GN 1/1





» Fiber Kaydırmaz Yuvarlak Tepsi
Fiber Non-slip Round Tray

Kod Code	Ø (cm) Ø (cm)
68210035	35,5
68210040	40,6
68210045	45

» Maun Kaydırmaz Yuvarlak Tepsi
Wooden Non-slip Round Tray

Kod Code	Ø (cm) Ø (cm)
68110033	33
68110038	38
68110043	43

» Maun Yuvarlak Tepsi
Wooden Round Tray

Kod Code	Ø (cm) Ø (cm)
68010033	33
68010038	38
68010043	43



» Fiber Kaydırmaz Dikdörtgen Tepsi
Fiber Non-slip Rectangular Tray

Kod Code	Ölçü (cm) Dim. (cm)
68213040	30x40
68213753	37x53
68214565	45x65
68215668	56x68

» Maun Kaydırmaz Dikdörtgen Tepsi
Wooden Non-slip Rectangular Tray

Kod Code	Ölçü (cm) Dim. (cm)
68112738	27x38
68113244	32x44
68113646	36x46
68113753	37x53
68114361	43x61

» Ecoform Kaydırmaz Tepsi
Ecoform Non-slip Rectangular Tray

Kod Code	Ölçü (cm) Dim. (cm)
68413753	37x53

» Kırçılı Tepsi
Textured Tray

Kod Code	Ölçü (cm) Dim. (cm)
46612736	27x36
46613244	32x44
46613646	36x46
46613753	37x53

» Maun Dikdörtgen Tepsi
Wooden Rectangular Tray

Kod Code	Ölçü (cm) Dim. (cm)
68012738	27x38
68013244	32x44
68013646	36x46
68013753	37x53
68014361	43x61

» Ecoform Tepsi
Ecoform Rectangular Tray

Kod Code	Ölçü (cm) Dim. (cm)
68313753	37x53

Tepsiler / Trays



» 1/1 GN Tepsi 1/1 GN Tray

Kod Code	Ölçü (mm) Dim. (mm)	lt lt
31611010	530x325x10	1,25
31611020	530x325x20	2,5
31611040	530x326x40	5

» 2/3 GN Tepsi 2/3 GN Tray

Kod Code	Ölçü (mm) Dim. (mm)	lt lt
31623010	354x325x10	0,75
31623020	354x325x20	1,5
31623040	354x325x40	3

» 1/2 GN Tepsi 1/2 GN Tray

Kod Code	Ölçü (mm) Dim. (mm)	lt lt
31612010	325x265x10	0,5
31612020	325x265x20	1,25
31612040	325x265x40	2,5



plast|port

» Desenli Basket Tepsi Figured Tray

Kod Code	Ölçü (mm) Dim. (mm)
31611005	530x325

» Servis Tepsi (ABS) Serving Tray (ABS)

Kod Code	Ölçü (cm) Dim. (cm)
46012736	27x36
46013244	32x44
46013646	36x46
46013753	37x53

» Self Servis Standard Self Service

Kod Code	Ölçü (mm) Dim. (mm)	Kalınlık Thickness
35040050	280x400x25	0,50 mm
35040060	280x400x25	0,60 mm
35040070	280x400x25	0,70 mm
35040080	280x400x25	0,80 mm
35040100	280x400x25	1,00 mm



120



» Bölmeli Self Servis 3 Partition Self Service

Kod Code	Ölçü (cm) Dim. (cm)	Model Model
35820003	12x25,5x1,5	3 Bölmeli
35820004	Ø 23x2	3 Partition 5 Bölmeli 5 Partition

» Standart Self Servis PC Standart Self Service PC

Kod Code	Ölçü (mm) Dim. (mm)	Model Model
46010111	398x278x28	Standart
46010112	360x245x26	Kreş

» Kahvaltılık Self Servis PC Self Service for Breakfast PC

Kod Code	Ölçü (mm) Dim. (mm)	Model Model
46010113	290x180x18	Kahvaltılık Breakfast
46010114	290x180x18	Yumurta w/Egg Part
46010115	400x280x30	Hindistan Indian



» Kaynaklı Keççe
Ladle

Kod Code	Ø (cm) Ø (cm)	Kapasite(gr) Capacity (gr)
31500001	7,8	75
31500002	8,8	100
31500003	9,5	145
31500004	10,7	220
31500005	13,2	456
31500016	15,5	661
31500007	18	975
31500008	20,7	1398
31500009	22,5	2150
31500010	25	3050

» Monoblok Keççe
Monoblock Ladle

Kod Code	Ø (cm) Ø (cm)	Kapasite(gr) Capacity (gr)
31500065	6,5	63
31500080	8	125
31500090	9	200
31500100	10	250
31500120	12	500
31500140	14	750
31500160	16	1000
31500180	18	1250
31500200	20	2050

» Sos Keççesi
Sauce Ladle

Kod Code	Ø (cm) Ø (cm)	Kapasite(gr) Capacity (gr)
31503017	5,5	67,5
31503018	6,5	70
31503019	7	72,5
31503020	7,8	75

* Ø 15,5 cm ve üzeri keççeler desteklidir.
* Ø 15,5 cm and above are reinforced

121



» Kaynaklı Kevgir
Skimmer

Kod Code	Ø (cm) Ø (cm)
31600001	9,3
31600002	10,4
31600003	11,3
31600004	12,9
31600005	15,1
31600016	17,4
31600007	19,7
31600008	22,2
31600009	25,1
31600010	28

» Monoblok Kevgir
Monoblock Skimmer

Kod Code	Ø (cm) Ø (cm)
31600080	8
31600100	10
31600120	12
31600140	14
31600160	16
31600180	18
31600200	20

» Pilav Servis (Kaynaklı)
Service Spoon

Kod Code	Ø (cm) Ø (cm)
31600021	9,3
31600022	10,4
31600023	11,3
31600024	12,9
31600025	15,1
31600026	17,4

* Ø 15,1 cm ve üzeri keççeler desteklidir.
* Ø 15,1 cm and above are reinforced





» Monoblok Düz Kaşık
Monoblock Spoon

Kod Code	Uzunluk (cm) L (cm)
31601106	27
31600104	38
31601104	43



» Monoblok Süzgeçli Kaşık
Monoblock Perforated Spoon

Kod Code	Uzunluk (cm) L (cm)
31601107	27
31600105	38
31601105	43



» Düz Servis Kaşık
Serving Spoon

Kod Code	Uzunluk (cm) L (cm)
90000009	21
90000006	30
90000005	43



» Süzgeçli Servis Kaşık
Perforated Serving Spoon

Kod Code	Uzunluk (cm) L (cm)
90000010	21
90000008	30
90000004	43



» Et Çatalı (Monoblok)
Monoblock Meat Fork

Kod Code	Uzunluk (cm) L (cm)	Model Model
31602104	50	İkili/2 Prongs
31601002	70	İkili/2 Prongs
31601003	50	Üçlü/3 Prongs
31601004	70	Üçlü/3 Prongs



» Servis Çatalı
Meat Fork for Serving

Kod Code	Uzunluk (cm) L (cm)
90000011	21
90000007	30



» Monoblok Servis Spatula
Monoblock Spatula

Kod Code	Uzunluk (cm) L (cm)
52020021	21
52020030	30
52020036	36



» Monoblok Süzgeçli Servis Spatula
Monoblock Perforated Spatula

Kod Code	Uzunluk (cm) L (cm)
52021021	21
52021030	30
52021036	36



» Servis Spatula
Serving Spatula

Kod Code	Uzunluk (cm) L (cm)
90000015	21
90000012	30



» Süzgeçli Servis Spatula
Perforated Serving Spatula

Kod Code	Uzunluk (cm) L (cm)
90000014	21
90000013	30

Servis Seti / Serving Set

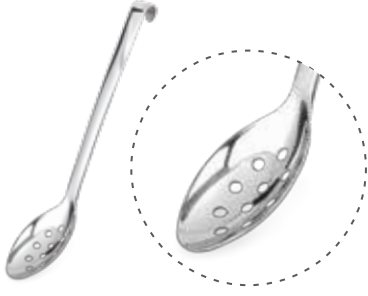

» Delikli Servis Kasık
Perforated Spoon

Kod Code	Ölçü (mm) Dim. (mm)
52010046	275x53



» Servis Kasığı
Serving Spoon

Kod Code	Ölçü (mm) Dim. (mm)
52010045	275x62

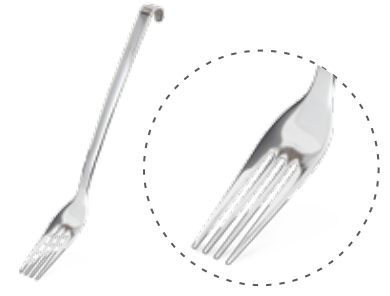

» Servis Çatalı
Serving Fork

Kod Code	Ölçü (mm) Dim. (mm)
52010043	285x45

124



» Kevgir
Skimmer

Kod Code	Ölçü (mm) Dim. (mm)
52010042	270x80



» Delikli Spatula
Perforated Turner

Kod Code	Ölçü (mm) Dim. (mm)
52010044	285x75



» Spagetti Kasığı
Spaghetti Spoon

Kod Code	Ölçü (mm) Dim. (mm)
52010058	270x65



» Sos Kepçesi
Sauce Ladle

Kod Code	Ölçü (mm) Dim. (mm)
52010041	253x73



» Çorba Kepçesi
Ladle

Kod Code	Ölçü (mm) Dim. (mm)
52010041	245x60



» Delikli Kek Servis
Perforated Spatula

Kod Code	Ölçü (mm) Dim. (mm)
52010049	315x63



-40°C ~ +230°C

- » Silikon Spatula
Silicone Spatula

Kod Code	Ölçü (mm) Dim. (mm)
52030001	370x155



-40°C ~ +230°C

- » Silikon Spagetti Kaşığı
Silicone Spaghetti Spoon

Kod Code	Ölçü (mm) Dim. (mm)
52030004	320x60



-40°C ~ +230°C

- » Silikon Kevgir
Silicone Skimmer

Kod Code	Ölçü (mm) Dim. (mm)
52030002	370x100



-40°C ~ +230°C

- » Silikon Kaşık
Silicone Spoon

Kod Code	Ölçü (mm) Dim. (mm)
52030003	330x65



-40°C ~ +230°C

- » Silikon Maşa (Kilitli)
Silicone Tong

Kod Code	Ölçü (cm) Dim. (cm)
52030040	30



-40°C ~ +230°C

- » Silikon Çok Amaçlı Maşa (Kilitli)
Silicone Multi-Purpose Tong

Kod Code	Ölçü (mm) Dim. (mm)
52031030	370x100



-40°C ~ +230°C

- » Silikon Spagetti Maşa (Kilitli)
Silicone Spaghetti Tong

Kod Code	Ölçü (cm) Dim. (cm)
52030030	30



-40°C ~ +230°C

- » Silikon Servis Maşa (Kilitli)
Silicone Serving Tong

Kod Code	Ölçü (cm) Dim. (cm)
40306021	30



- » Silikon Saplı Servis Maşa
Serving Tong w/Silicone Handle

Kod Code	Ölçü (cm) Dim. (cm)
40306020	22



460 461 462

- » PC Servis Kaşığı
PC Serving Spoon

Kod Code	Model Model
46010007	Düz Spoon
46010008	Delikli Perforated Spoon



- » PC Sos Kepçe
PC Sauce Ladle

Kod Code	Ölçü (cm) Dim. (cm)
46010009	20
46010015	24



- » PC Maşa
PC Tong

Kod Code	Model Model
46010018	Makarna Pasta
46010021	Servis Serving



» Makaslı Maşa
Salad Tong

Kod Code	Ölçü (cm) Dim. (cm)
52010181	25



» Makaslı Maşa
Bread/Pastry Tong

Kod Code	Ölçü (cm) Dim. (cm)
52010187	25



» Makaslı Maşa
Serving Tong

Kod Code	Ölçü (cm) Dim. (cm)
52010189	25

126

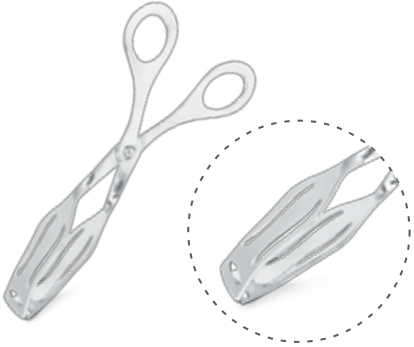

» Makaslı Maşa Küçük
Bread/Pastry Tong Small

Kod Code	Ölçü (cm) Dim. (cm)
52020003	19,5



» Makaslı Maşa Küçük
Salad Tong Small

Kod Code	Ölçü (cm) Dim. (cm)
52020005	19,5



» Çok Amaçlı Maşa
Multi-Purpose Tong

Kod Code	Ölçü (cm) Dim. (cm)
52010 710	25



» Spagetti Maşa Lüks
Spaghetti Tong Lux

Kod Code	Ölçü (cm) Dim. (cm)
52020002	24



» Spagetti Maşa
Pasta Tong

Kod Code	Ölçü (cm) Dim. (cm)
36302000	22



» Çok Amaçlı Maşa
Multi-Purpose Tong

Kod Code	Ölçü (cm) Dim. (cm)
62010030	30
62010141	41



NEW



» Şef Cımbızı
Chef's Tong

Kod Code	Ölçü (mm) Dim. (mm)	Model Model
77502913	145x10	Düz/Straight
77502021	200x25	Belli/Angular
77500025	250	Düz/Straight

» Salata Maşa
Salad Tong

Kod Code	Ölçü (cm) Dim. (cm)
36310000	22

» Pasta Maşa
Pastry Tong

Kod Code	Ölçü (cm) Dim. (cm)
36311000	21,5



» Geniş Ağızlı (Hamburger) Maşa
Wide (Hamburger) Tong

Kod Code	Ölçü (cm) Dim. (cm)
52010713	24

» Izgara Maşa
Grill Tong

Kod Code	Ölçü (cm) Dim. (cm)
36306001	25
36306002	27,5
36306003	32,5
36306004	40

» Kömür Maşa
Charcoal Tong

Kod Code	Ölçü (cm) Dim. (cm)
36306011	25
36306012	27,5
36306013	32,5
36306014	40



» Buz Maşa
Ice Tong

Kod Code	Ölçü (cm) Dim. (cm)	Model Model
36303000	16	Classic/Klasik
52020004	19	Lüks/Lux



» Şeker Maşa
Sugar Tong

Kod Code	Ölçü (cm) Dim. (cm)
40306022	23



» Kılçık Temizleme Maşası
Fish Bone Pincer

Kod Code	Ölçü (cm) Dim. (cm)
36304000	12



» Dekor Kaşık Seti
Deco Spoon Set

Kod Code	Ø (mm) Ø (mm)	h (mm) h (mm)
77506436	75	55



» Melamin Kaşık Standı
Melamine Spoon Rest

Kod Code	Model Model
84010016	Beyaz White
84110016	Siyah Black

128



» Kaşık Standı
Spoon Rest

Kod Code
52010183



» Kepçe/Kaşık Standı
Spoon/Ladle Rest

Kod Code	Ölçü (cm) Dim. (cm)
62010009	9x17

* Fiyata kepçe dahil değildir.
* Ladle is not included



» Dondurma/Ördövr Makası
Ice Cream Spoon

Kod Code	Ø (mm) Ø (mm)
52019039	39
52019044	44
52019050	50
52019056	56
52019063	63



» Dondurma Kaşığı
Ice Cream Spoon

Kod Code
62010037



» Pilav Ölçeği
Rice Scoop

Kod Code	Ø (mm) Ø (mm)	No No
39330001	8	1
39330002	8,5	2
39330003	9,5	3
39330004	10,5	4
39330005	13,5	5



» Patates Küreği
French Fries Shovel

Kod Code	Ölçü (cm) Dim. (cm)
62010000	20



plast|port
» Ketçap Dispenseri
Ketchup Dispenser

Kod	Lt
Code	Lt
46010022	2



plast|port
» Mayonez Dispenseri
Mayonnaise Dispenser

Kod	Lt
Code	Lt
46010023	2



plast|port
» Hardal Dispenseri
Mustard Dispenser

Kod	Lt
Code	Lt
46010025	2



» Ketçap Şişesi
Ketchup Bottle

Kod	ml
Code	ml
43030250	250
43030500	500
43030750	750



» Mayonez Şişesi
Mayonnaise Bottle

Kod	ml
Code	ml
43031250	250
43031500	500
43031750	750



» Hardal Şişesi
Mustard Bottle

Kod	ml
Code	ml
43032250	250
43032500	500
43032750	750



» Şeffaf Sos Şişesi
Transparent Sauce Bottle

Kod	ml
Code	ml
43033250	250
43033500	500
43033750	750



» Sos/Şurup Dökücü
Pouring Container

Kod	ml
Code	ml
60020001	1
60020002	2





Açık Büfe

Open Buffet





» GN 1/1 Dövmeli Bakır Chafing Dish
GN 1/1 Copper Chafing Dish

Kod Code	Ölçü (cm) Dim. (cm)	Kapasite(Lt) Capacity (Lt)
55012012	69x49,5x52	12



» Yuvarlak Dövmeli Bakır Chafing Dish
Round Copper Chafing Dish

Kod Code	Ölçü (cm) Dim. (cm)	Kapasite(Lt) Capacity (Lt)
55012062	50x48x49,5	7

VEGA CHAFING DISH

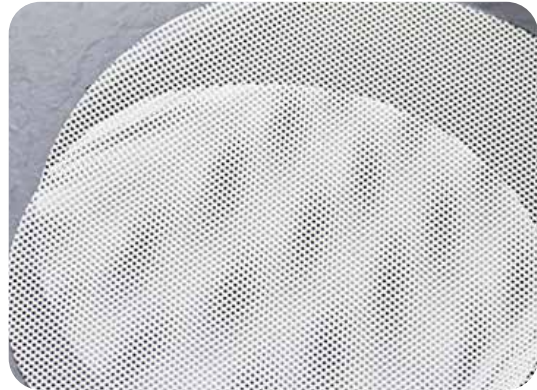

- 1 Kendinden Elektrikli Isıtıcı
Self Electrical Heating
- 2 Su Geçirmez Kontrol
Waterproof Switch
- 3 90° de sabitlenebilir kapak
Stable at 90°
- 4 Çıkarılabilir Elektrik Kablosu
Removable power cord
- 5 Silikon Koruyucu
Silicone Protector Pad

Çıkarılabilir Kapak
Removable Cover

Geniş Cam Kapak
Full Glass Window

Hidrolik Kapak
Hydraulic Lid



NEW



54010101

İndüksiyon ocaklara uygundur
Suitable for Induction Plates

136

Kod Code	Model Model	Ölçü (cm) Dim. (cm)
56012011	GN 1/1 - 9 lt.	63x46x17
54010101	İndüksiyon Isıtıcı 1000W/220V Induction Heating 1000W/220V	

Kendinden Elektrikli Isıtıcı
Self Electrical Heating System



Hidrolik Kapak
Hydraulic Lid



Su Geçirmez Kontrol
Waterproof Switch



Çıkarılabilir Elektrik Kablosu
Removable power cord



Hidrolik Kapak
Hydraulic Lid



NEW



54010101

İndüksiyon ocaklara uygundur
Suitable for Induction Plates

Kod Code	Model Model	Ölçü (cm) Dim. (cm)
56012032	GN 2/3 - 6 lt.	48x46x17
54010101	İndüksiyon Isıtıcı 1000W/220V Induction Heating 1000W/220V	

137

Kendinden Elektrikli Isıtıcı
Self Electrical Heating System



Hidrolik Kapak
Hydraulic Lid



Su Geçirmez Kontrol
Waterproof Switch



Çıkarılabilir Elektrik Kablosu
Removable power cord



Hidrolik Kapak
Hydraulic Lid





54010101

İndüksiyon ocaklara uygundur
Suitable for Induction Plates

138

Kod Code	Model Model	Ölçü (cm) Dim. (cm)
56012060	Yuvarlak - 6 lt. / Round - 6 lt	50x50x17
54010101	İndüksiyon Isıtıcı 1000W/220V Induction Heating 1000W/220V	

Kendinden Elektrikli Isıtıcı
Self Electrical Heating System



Hidrolik Kapak
Hydraulic Lid



Su Geçirmez Kontrol
Waterproof Switch



Çıkarılabilir Elektrik Kablosu
Removable power cord



Hidrolik Kapak
Hydraulic Lid



NEW



54010101

İndüksiyon ocaklara uygundur
Suitable for Induction Plates

>> Kod
Code

Model
Model

Ölçü (cm)
Dim. (cm)

56012015

Çorbalık - 11 lt. / Soup Station- 11lt

40x40x28,5

54010101

İndüksiyon Isıtıcı 1000W/220V
Induction Heating 1000W/220V

Kendinden Elektrikli Isıtıcı
Self Electrical Heating System



Hidrolik Kapak
Hydraulic Lid

Su Geçirmez Kontrol
Waterproof Switch

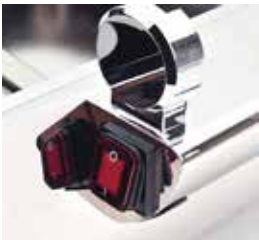

Çıkarılabilir Elektrik Kablosu
Removable power cord



Hidrolik Kapak
Hydraulic Lid



CARINA CHAFING DISH



90 ° de Sabitlenebilir Kapak

Kapak yavaşça ve sessizce otomatik olarak kapanır
Çıkarılabilir kapak kolay temizlik ve depolama sağlar

Open up to 90 °

*Lid falls and closed automatically silently
Removable cover: easy for cleaning and storage*

Buhar Toplama Sistemi
Buhardan oluşan su damlaları
su kabına geri akar yemeğin
üzerine akmaz

*Water Return System
Condensation flows back to
water pan instead of food*

Patentli Hidrolik Mentеше
Min. 100.000 açma-kapama

*Patented Hydraulic Hinge
Min. 100.000 times open-close*

3 Kat Çelik Taban
Hızlı ve eşit pişirme için

*Three-layer Steel Bottom
for fast and even heating*

NEW

Hidrolik Kapak
Hydraulic Lid



142

54010101

İndüksiyon ocaklara uygundur
Suitable for Induction Plates

Kod Code	Model Model	Ölçü (cm) Dim. (cm)
55012011	GN 1/1 - 11,2 lt.	58x47,5x17
55013011	GN 1/1 Ayaklı Stand/ Stand	61,5x40x17,5
54010101	İndüksiyon Isıtıcı 1000W/220V Induction Heating 1000W/220V	

55012011



55013011



55013011



55012011

NEW

Hidrolik Kapak
Hydraulic Lid

54010101

İndüksiyon ocaklara uygundur
Suitable for Induction Plates

55012032

55012035

143

» Kod Code	Model Model	Ölçü (cm) Dim. (cm)
55012032	GN 2/3 - 5,5 lt.	47,5x41x17
55012035	GN 2/3 Ayaklı Stand/ Stand	43,5x40x17,5
54010101	İndüksiyon Isıtıcı 1000W/220V Induction Heating 1000W/220V	

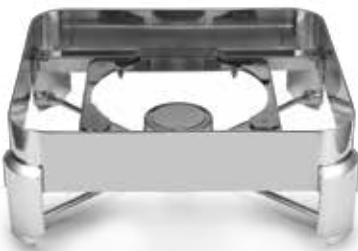

55012035



55012032

NEW

Hidrolik Kapak
Hydraulic Lid



54010101

Indüksiyon ocaklara uygundur
Suitable for Induction Plates



55012060

55012065

144

Kod Code	Model Model	Ölçü (cm) Dim. (cm)
55012060	Yuvarlak 5,7 Lt. / Round 5,7 Lt	53,5x45,5x17
55012065	Yuvarlak Ayaklı Stand / Round Stand	44,5x44,5x17,5
54010101	İndüksiyon Isıtıcı 1000W/220V Induction Heating 1000W/220V	



55012065



55012060

NEW

Hidrolik Kapak
Hydraulic Lid

54010101

İndüksiyon ocaklara uygundur
Suitable for Induction Plates

55012015

55012018

145

Kod Code	Model Model	Ölçü (cm) Dim. (cm)
55012015	Çorbalık 14,3 Lt./ Soup Station 14.3 Lt.	47,5x43,5x26,5
55012018	Çorbalık Ayaklı Stand/ Soup Station Stand	37x37x17,5
54010101	İndüksiyon Isıtıcı 1000W/220V Induction Heating 1000W/220V	



55012018



55012015



Kendinden Buz Hazneli Kapak
Lid has Self Ice Store



NEW

» Carina İçecek Dispenseri
Carina Juice Dispenser

Kod	(Lt)
Code	(Lt)
55011112	7,7



NEW

» Carina İçecek Dispenseri
Carina Juice Dispenser

Kod	(Lt)
Code	(Lt)
55011277	7,7
55011278	2x7,7
55011279	3x7,7



NEW

» Carina Kahve Dispenseri
Carina Coffee Dispenser

Kod	(Lt)
Code	(Lt)
55011019	7,7



NEW

» Carina Süt Dispenseri
Carina Milk Dispenser

Kod	(Lt)
Code	(Lt)
55011212	6,4



NEW

» Carina Corn Flakes Dispenseri
Carina Sereal Dispenser

Kod	(Lt)
Code	(Lt)
55011231	3,7
55011232	2x3,7
55011233	3x3,7



Lux Chafing Dish Özellikler

Luxe Chafing Dish Specifications



148

- 1 İndüksiyon Isıtıcılarla uyumlu
Suitable for Induction Plates
- 2 Hidrolik Kapak
Hydraulic Lid
- 3 3 Üst üste muhafaza edebilme özelliği
Stackable Design
- 4 Cam kapak
Glass Lid
- 5 90° de sabitlenebilir kapak
Stable at 90°



Hidrolik Kapak
Hydraulic Lid



54012011



54012011

İndüksiyon ocaklara uygundur
Suitable for Induction Plates

54013011

Kod Code	Model Model	Ölçü (cm) Dim. (cm)
54012011	GN 1/1 - 9 lt.	57,5x47x16
54013011	GN 1/1 Ayaklı Stand/ Stand	66x38x25
54010101	İndüksiyon Isıtıcı 1000W/220V Induction Heating 1000W/220V	



54013011



54010101

149

Hidrolik Kapak
Hydraulic Lid



54012032



54012032

İndüksiyon ocaklara uygundur
Suitable for Induction Plates

54012035

Kod Code	Model Model	Ölçü (cm) Dim. (cm)
54012032	GN 2/3 - 6 lt.	46,5x41x20
54012035	GN 2/3 Ayaklı Stand/ Stand	49x38x25
54010101	İndüksiyon Isıtıcı 1000W/220V Induction Heating 1000W/220V	



54012035



54010101

Lux Chafing Dish

Hidrolik Kapak
Hydraulic Lid



54012021



54012021

İndüksiyon ocaklara uygundur
Suitable for Induction Plates

> Kod Code	Model Model	Ölçü (cm) Dim. (cm)
54012021	GN 1/2 - 4 lt.	46x32x20
54012024	GN 1/2 Ayaklı Stand/ Stand	41x38x25
54010101	İndüksiyon Isıtıcı 1000W/220V Induction Heating 1000W/220V	



54010101



54012024

150

Hidrolik Kapak
Hydraulic Lid



54012060



54012060

İndüksiyon ocaklara uygundur
Suitable for Induction Plates

> Kod Code	Model Model	Ölçü (cm) Dim. (cm)
54012060	Yuvarlak 6 Lt. / Round 6 Lt	51,5x45x20
54012065	Yuvarlak Ayaklı Stand/ Round Stand	45x45x20
54010101	İndüksiyon Isıtıcı 1000W/220V Induction Heating 1000W/220V	



54010101



54012065

Hidrolik Kapak
Hydraulic Lid



54012015

54012018



54012015

İndüksiyon ocaklara uygundur
Suitable for Induction Plates

Kod Code	Model Model	Ölçü (cm) Dim. (cm)
54012015	Çorbalık 11 Lt./ Soup Station 11 Lt.	47x42x30
54012018	Çorbalık Ayaklı Stand/ Soup Station Stand	38x38x20
54010101	İndüksiyon Isıtıcı 1000W/220V Induction Heating 1000W/220V	



54012018



54010101

151

Kendinden Buz Hazneli Kapak
Lid has Self Ice Store



Paslanmaz Çelik Musluk
Stainless Steel Tap



Paslanmaz Çelik Musluk
Stainless Steel Tap



» Lux İçecek Dispenseri
Lux Juice Dispenser

Kod Code	(Lt) (Lt)
54012112	12

» Lux Kahve Dispenseri
Lux Coffee Dispenser

Kod Code	(Lt) (Lt)
54012212	12

Fusion Chafing Dish Özellikler

Fusion Chafing Dish Specifications

- 90°'de kolay çıkarılabilir kapak
- Hafif ve kolay kullanılabilir kapak
- Kullanılırken kapağın yerinden çıkmasını engelleyen otomatik bloke sistemi (0°'den 89°'ye kadar)
- Açılıp kapanırken yavaşlayan patentli menteşe sistemi
- 0°'yle 70° arası bırakıldığı yerde durabilen mekanizma
- 70°'den sonra bırakıldığında otomatik açılma
- Patentli esnek yaylı menteşe mekanizması sayesinde zaman içinde aşınma olmaz değişim veya bakıma gerek duymaz
- Tamamı paslanmaz çelik gövde
- Buharı toplamak üzere tasarlanmış özel gövde
- Elektrikli ve Jelli ısıtıcılarla kullanıma uygundur

- Easily removable cover, at 90°
- Light and easy-to-handle cover
- Automatic block of cover pull out when in operation (from 0° to 89°)
- Closing and opening slowed by cover thanks to patented system
- The cover stops, when released, in any position from 0° to 70°
- Over 70° the cover opens fully when released
- The hinge is a spring mechanism, inalterable in time, it does not need regulation and maintenance as it has no clutch
- All the machineries are built in refined stainless materials, thus resistant to corrosion, humid environment and suitable for food contact
- The chafing dish is designed to collect condensation, in order to keep the support base completely dry
- Both electric warming and solid-fuelburners can be used
- Not suitable for induction cookers

152



Patentli Kapak
Patented Lid



54010800

» GN 1/1 Cam Kapaklı Chafing Dish

GN 1/1 Chafing Dish w/Glass Windowed Lid

Kod
Code

74012012

54010800

Model
Model

GN 1/1 - 9 lt.

9 Kademeli Termostatlı Isıtıcı

Electrical Heating Unit w/9 Temperature Control

Ölçü (cm)
Dim. (cm)

49x49x33

* İndüksiyon ocaklarla uyumlu değildir

* Not suitable for induction cookers



54010800

» GN 2/3 Cam Kapaklı Chafing Dish
GN 2/3 Chafing Dish w/Glass Windowed Lid

Kod Code	Model Model	Ölçü (cm) Dim. (cm)
74012034	GN 2/3 - 6 lt.	46x42x32
54010800	9 Kademeli Termostatlı Isıtıcı Electrical Heating Unit w/9 Temperature Control	

* İndüksiyon ocaklarla uyumlu değildir

* Not suitable for induction cookers



» Fusion İçecek Dispenseri
Fusion Juice Dispenser

Kod Code	(Lt) (Lt)
74011112	12



» Fusion Kahve Dispenseri
Fusion Coffee Dispenser

Kod Code	(Lt) (Lt)
74011000	10



» Fusion Corn Flakes Dispenseri
Fusion Corn Flakes Dispenser

Kod Code	(Lt) (Lt)
74011231	7

Premium Chafing Dish



Hidrolik Kapak
Hydraulic Lid



54011014

54011011



54011011

İndüksiyon ocaklara uygundur
Suitable for Induction Plates

Kod Code	Model Model	Ölçü (cm) Dim. (cm)
54011011	GN 1/1 - 9 lt.	59,5x46x23,5
54011014	GN 1/1 Ayaklı Stand/ Stand	52x42x17,5
54010101	İndüksiyon Isıtıcı 1000W/220V Induction Heating 1000W/220V	



54010101



54011014

155

Hidrolik Kapak
Hydraulic Lid



54011035

54011032



54011032

İndüksiyon ocaklara uygundur
Suitable for Induction Plates

Kod Code	Model Model	Ölçü (cm) Dim. (cm)
54011032	GN 2/3 - 6 lt.	46x42x22,5
54011035	GN 2/3 Ayaklı Stand/ Stand	42x38x218
54010101	İndüksiyon Isıtıcı 1000W/220V Induction Heating 1000W/220V	



54010101



54011035

Premium Chafing Dish

Hidrolik Kapak
Hydraulic Lid



54011021



54011021

İndüksiyon ocaklara uygundur
Suitable for Induction Plates

» Kod Code	Model Model	Ölçü (cm) Dim. (cm)
54011021	GN 1/2 - 4 lt.	46x33x23
54011024	GN 1/2 Ayaklı Stand/ Stand	42x30x18
54010101	İndüksiyon Isıtıcı 1000W/220V Induction Heating 1000W/220V	



54011024



54010101

156

Hidrolik Kapak
Hydraulic Lid



54011060



54011060

İndüksiyon ocaklara uygundur
Suitable for Induction Plates

» Kod Code	Model Model	Ölçü (cm) Dim. (cm)
54011060	Yuvarlak 6 Lt. / Round 6 Lt	52,5x46x22,5
54011160	Yuvarlak Ayaklı Stand/ Round Stand	43,5x33x18
54010101	İndüksiyon Isıtıcı 1000W/220V Induction Heating 1000W/220V	



54011160



54010101

Hidrolik Kapak
Hydraulic Lid



54011015



54011015

İndüksiyon ocaklara uygundur
Suitable for Induction Plates

54011018

» Kod Code	Model Model	Ölçü (cm) Dim. (cm)
54011015	Çorbalık 11 Lt./ Soup Station 11 Lt.	44x44x33
54011018	Çorbalık Ayaklı Stand/ Soup Station Stand	43,5x33x18
54010101	İndüksiyon Isıtıcı 1000W/220V Induction Heating 1000W/220V	



54011018



54010101



• Kendinden buz hazneli kapak
• Lid has self ice store

» Premium Süt Dispenseri
Premium Milk Dispenser

Kod Code	(Lt) (Lt)
54011212	6



» Premium İçecek Dispenseri
Premium Juice Dispenser

Kod Code	(Lt) (Lt)
54011112	12



» Premium Kahve Dispenseri
Premium Coffee Dispenser

Kod Code	(Lt) (Lt)
59011019	19

Chafing Dish Standları / Chafing Dish Stands



158

» 1/1 Indüksiyon Chafing Dish Standı
1/1 Stand w/Warmer

Kod
Code
54014011

* İndüksiyon ocaklar fiyata dahildir. * *Induction cookers included*



» 2/3 Indüksiyon Chafing Dish Standı
2/3 Stand w/Warmer

Kod
Code
54014032



» Yuvarlak Indüksiyon Chafing Dish Standı
Round Stand w/Warmer

Kod
Code
54014060

* İndüksiyon ocaklar fiyata dahildir. * *Induction cookers included*



Delux Chafing Dish Genel Özellikler Delux Chafing Dish Specifications



- 1 90° de sabitlenebilir kapak
Stable at 90°
- 2 180° açılır kapak
Stable at 180°
- 3 Kolay çıkarılabilir, yıkanabilir kapak
For quick and easy cleaning
- 4 9 kademeli termostatlı ısıtıcı
Electrical heating unit w/9 Temperature Control
- 5 5 Üst üste muhafaza edilebilme özelliği
Stackable Design

Delux Chafing Dish



» GN 1/1 Roll Top
GN 1/1 Roll Top

Kod Code	Model Model	Ölçü (cm) Dim. (cm)
54010733	9 lt. Jelli/ w/Burner	73x49x34
54010800	Termostatlı Isıtıcı/ Electrical Heater	



» GN 2/3 Roll Top Cam Kapaklı
GN 2/3 Roll Top w/Glass Windowed Lid

Kod Code	Model Model	Ölçü (cm) Dim. (cm)
54014732	6 lt. Jelli/w/Burner	51x49x34
54010800	Termostatlı Isıtıcı/ Electrical Heater	

160

ÖZELLİKLER

- 90° de sabitlenebilir kapak
- 180° açılır kapak
- Kolay çıkarılabilir, yıkanabilir kapak
- 9 kademeli termostatlı ısıtıcı
- Üst üste muhafaza edilebilme özelliği



» Yuvarlak Roll Top
Round Roll Top

Kod Code	Model Model	Ölçü (cm) Dim. (cm)
54010731	6 lt. Jelli/w/Burner	53x53x35
54010800	Termostatlı Isıtıcı/ Electrical Heater	



» Roll Top Çift Çorbalık
Roll Top w/Soup Tureens

Kod Code	Model Model	Ölçü (cm) Dim. (cm)
54010738	2x4,5 lt. Jelli/w/Burner	73x49x34
54010800	Termostatlı Isıtıcı/ Electrical Heater	



» Roll Top Çorbalık

Round Roll Top w/Soup Tureens

Kod Code	Model Model	Ölçü (cm) Dim. (cm)
54010730	6 lt. Jelli/w/Burner	53x53x35
54010800	Termostatlı Isıtıcı/ Electrical Heater	



» Gömme GN 1/1

Built-In GN 1/1



Kod Code	Model Model	Ölçü (cm) Dim. (cm)
54012733	9 lt. Jelli/ w/Burner	63x46,5x24
54010800	Termostatlı Isıtıcı/ Electrical Heater	



SPECIFICATIONS

- Stable at 90°
- Stable at 180°
- For quick & easy cleaning
- Electrical heating unit w/9 Temperature Control
- Stackable design

161



» Gömme Yuvarlak

Built-In Round Shaped

Kod Code	Model Model	Ölçü (cm) Dim. (cm)
54012731	6 lt. Jelli/w/Burner	63x48x26
54010800	Termostatlı Isıtıcı/ Electrical Heater	



» Gömme Çorbalık

Built-In Round Shaped w/Soup Tureen

Kod Code	Model Model	Ölçü (cm) Dim. (cm)
54012730	6 lt. Jelli/w/Burner	63x48x26
54010800	Termostatlı Isıtıcı/ Electrical Heater	



Classic Chafing Dish



- » GN 1/1 Roll Top
GN 1/1 Roll Top

Kod Code	Model Model	Ölçü (cm) Dim. (cm)
54010723	9 lt. Jelli/ w/Burner	75x50x33
54010800	Termostatlı Isıtıcı/ Electrical Heater	



- » Yuvarlak Roll Top
Roll Top Round Shaped

Kod Code	Model Model	Ölçü (cm) Dim. (cm)
54010721	6 lt. Jelli/w/Burner	53x49,5x35
54010800	Termostatlı Isıtıcı/ Electrical Heater	

162



- » Çorbalık Roll Top
Round Shaped w/Soup Tureen

Kod Code	Model Model	Ölçü (cm) Dim. (cm)
54010720	6 lt. Jelli/w/Burner	53x49,5x35
54010800	Termostatlı Isıtıcı/ Electrical Heater	



- » Oval Roll Top
Eliptic Roll Top

Kod Code	Model Model	Ölçü (cm) Dim. (cm)
54010736	9 lt. Jelli/ w/Burner	66x56x33
54010800	Termostatlı Isıtıcı/ Electrical Heater	



» Ekonomik GN 1/1
Economic GN 1/1

Kod Code	Model Model	Ölçü (cm) Dim. (cm)
54010433	9 lt. Jelli 9 lt. w/Burner	60x35x32
54010434	9 lt. Elek. 9 lt. w/Electric Heating	60x35x32



» Mini Chafing Dish
Mini Chafing Dish

Kod Code	Model Model	Ölçü (cm) Dim. (cm)
40210151	Jelli w/Burner	32x32



» 9 Kademeli Termostatlı Isıtıcı
Electrical Heating Unit w/9 Temperature Control

Kod Code	Güç Power
54010800	700 Watt



» İndüksiyon Isıtıcı
Induction Heating

Kod Code	Güç Power
54010101	1000 W



» Yakıt Haznesi
Burner Holder

Kod Code
54010100



» İsimlik
Name Tag

Kod Code	h(cm) h(cm)
62010005	5
62011010	10
62013020	20



» Kaşık Standı
Spoon Rest

Kod Code
52010183



» Kepçe Standı
Spoon/Ladle Rest

Kod Code	Ölçü (cm) Dim. (cm)
62010009	9x17

Chafing Dish Kvetler / Chafing Dish Food Pans



GN 1/1 Porselen
» GN 1/1 Porcelain

Kod Code	l (mm) Dim. (mm)
70020101	530x325



» GN 1/2 Porselen
GN 1/2 Porcelain

Kod Code	l (mm) Dim. (mm)
70020102	325x265



» GN 2/3 Porselen
GN 2/3 Porcelain

Kod Code	l (mm) Dim. (mm)
70020203	354x325



» GN 1/3 Porselen
GN 1/3 Porcelain

Kod Code	l (mm) Dim. (mm)
70020103	325x176



» Yuvarlak Porselen
Round Porcelain

Kod Code	l (cm) Dim. (cm)
70020100	39x6,5



» Yuvarlak Blmeli Porselen
Round Divided Porcelain

Kod Code	l (cm) Dim. (cm)
70021100	39x6,5



» Yuvarlak Tepsi
Round Tray (S/S)

Kod Code	l (cm) Dim. (cm)	Lt Lt
30703565	35x6,5	6,2



» Yuvarlak Blmeli Tepsi
Round Divided Tray (S/S)

Kod Code	l (cm) Dim. (cm)
70023100	38,5x38,5x6,5

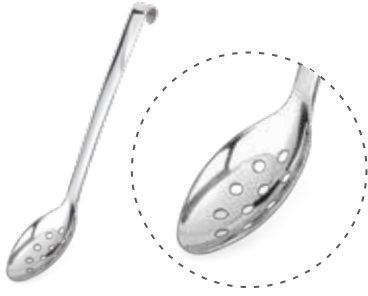

» Delikli Servis Kasık
Perforated Spoon

Kod Code	Ölçü (mm) Dim. (mm)
52010046	275x53



» Servis Kasığı
Serving Spoon

Kod Code	Ölçü (mm) Dim. (mm)
52010045	275x62

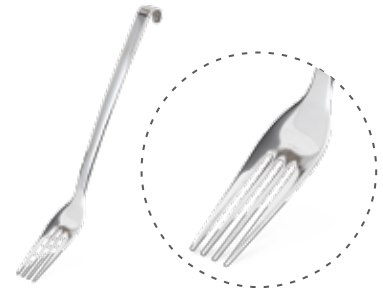

» Servis Çatalı
Serving Fork

Kod Code	Ölçü (mm) Dim. (mm)
52010043	285x45



» Kevgir
Skimmer

Kod Code	Ölçü (mm) Dim. (mm)
52010042	270x80



» Delikli Spatula
Perforated Turner

Kod Code	Ölçü (mm) Dim. (mm)
52010044	285x75



» Spagetti Kasığı
Spaghetti Spoon

Kod Code	Ölçü (mm) Dim. (mm)
52010058	270x65

165



» Sos Kepçesi
Sauce Ladle

Kod Code	Ölçü (mm) Dim. (mm)
52010041	253x73



» Çorba Kepçesi
Ladle

Kod Code	Ölçü (mm) Dim. (mm)
52010041	245x60



» Delikli Kek Servis
Perforated Spatula

Kod Code	Ölçü (mm) Dim. (mm)
52010049	315x63

Kendinden Buz Hazneli Kapak
Lid has Self Ice Store



NEW

» Carina İçecek Dispenseri
Carina Juice Dispenser

Kod	(Lt)
Code	(Lt)
55011112	7,7



NEW

» Carina Kahve Dispenseri
Carina Coffee Dispenser

Kod	(Lt)
Code	(Lt)
55011019	7,7



NEW

» Carina Süt Dispenseri
Carina Milk Dispenser

Kod	(Lt)
Code	(Lt)
55011212	6,4



NEW

» İçecek Dispenseri
Juice Dispenser

Kod	(Lt)
Code	(Lt)
55011277	7,7
55011278	2x7,7
55011279	3x7,7



» Lux İçecek Dispenseri
Lux Juice Dispenser

Kod	Lt
Code	Lt
54012112	12



» Lux Kahve Dispenseri
Lux Coffee Dispenser

Kod	Lt
Code	Lt
54012212	12



» Ice Tea Dispenseri (Cam)
Ice Tea Dispenser (Glass)

Kod	Lt
Code	Lt
59057900	7,9

* Ürün standsız da kullanılabilir.
* Can be use w/o wire stand



» Premium İçecek Dispenseri
Premium Juice Dispenser

Kod	Lt
Code	Lt
54011112	12



» Premium Kahve Dispenseri
Premium Coffee Dispenser

Kod	Lt
Code	Lt
59011019	19



» Lux Süt Dispenseri
Lux Milk Can

Kod	Lt
Code	Lt
54011212	6

• Kendinden buz hazneli kapak
• Lid has self ice store



» Fusion İçecek Dispenseri
Fusion Juice Dispenser

Kod	Lt
Code	Lt
74011112	12



» Fusion Kahve Dispenseri
Fusion Coffee Dispenser

Kod	Lt
Code	Lt
74011000	10

168



» Meyve Suyu Dispenseri
Juice Dispenser

Kod	Ölçü (cm)	Lt
Code	Dim. (cm)	Lt
59039021	37x23x60	7
59039022	37x45x69	14



» Fusion Corn Flakes Dispenseri
Fusion Corn Flakes Dispenser

Kod	Lt
Code	Lt
74011231	7



» Carina Corn Flakes Dispenseri
Carina Sereal Dispenser

Kod Code	(Lt) (Lt)
55011231	3,7
55011232	2x3,7
55011233	3x3,7



» Corn Flakes Dispenseri
Corn Flakes Dispenser

Kod Code	Ölçü (cm) Dim. (cm)	Lt Lt
54021231	42x23x62	7,5
54021232	42x45x6	15



» Corn Flakes Dispenseri
Corn Flakes Dispenser

Kod Code	Model Model
40010001	Tekli/Single
40010002	2'li/Double
40010003	3'lü/Triple



» Corn Flakes Dispenseri
Corn Flakes Dispenser

Kod Code	Lt Lt
54010010	10

Sıcak Tutucu Lambalar /Heat Retaning Infrared Lamps



- Kumanda anahtarlı açma kapama kontrolü
- Asansörlü ayarlanabilir uzunluk 55-130 cm
- 230 Volt / 1 Ph. / 50 Hz; 250 W
- Hem BOH (Back of the House) hem de FOH (Front of the House) kullanım için özel tasarım



470 471 472 473

» Klasik Infrared Lamba Classic Infrared Lamp

Kod Code	Renk Colour	Øxh (mm) Øxh (mm)
470 10006	Krom/Chrome	245x260
471 10006	Pirinç/Brass	245x260
472 10006	Bakır/Copper	245x260
473 10006	Siyah/Black	245x260

* Fiyata infrared ampül dahildir.

* w/infrared bulb



- Adjustable helix cable (55 - 130 cm)
- 230 Volt / 1 Ph. / 50 Hz; 250 W
- Suitable for both BOH (Back of the House) and FOH (Front of the House) using
- On - Off Switch



473 471 474 475

» Dome Infrared Lamba Dome Infrared Lamp

Kod Code	Renk Colour	Øxh (mm) Øxh (mm)
473 10014	Siyah/Black	270x320
471 10014	Pirinç/Brass	270x320
474 10014	Antrasit/Anthracite	270x320
475 10014	Bordo/Maroon	270x320

* Fiyata infrared ampül dahildir.

* w/infrared bulb

170



476 471 472 475

» Vintage Infrared Lamba Vintage Infrared Lamp

Kod Code	Renk Colour	Øxh (mm) Øxh (mm)
470 10006	Koyu Yeşil/Dark Green	310x265
471 10006	Pirinç/Brass	310x265
472 10006	Bakır/Copper	310x265
473 10006	Bordo/Maroon	310x265

* Fiyata infrared ampül dahildir.

* w/infrared bulb



477 473 474 475

» Konik Infrared Lamba Conic Infrared Lamp

Kod Code	Renk Colour	Øxh (mm) Øxh (mm)
477 10016	Parlak Alu./Anodised Alu.	155x270
473 10016	Siyah/Black	155x270
474 10016	Antrasit/Anthracite	155x270
475 10016	Bordo/Maroon	155x270

Sıcak Tutucu Lambalar /Heat Retaning Infrared Lamps

- Kısaltılabilir Askı Borusu : h. 140 cm
- 230 Volt / 1 Ph. / 50 Hz; 250 W
- Hem BOH (Back of the House) hem de FOH (Front of the House) kullanım için özel tasarım

- Hanging Rod: h.140 cm
- Can be shortened
- Suitable for both BOH (Back of the House) and FOH (Front of the House) using
- On - Off Switch

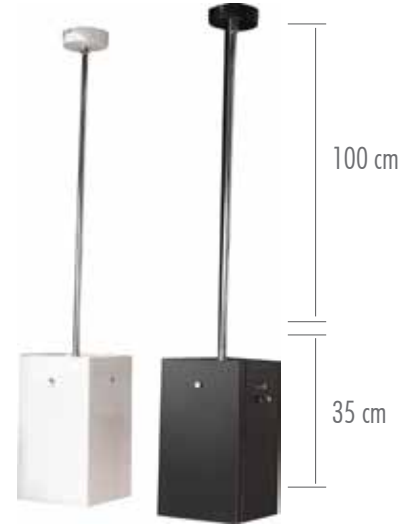

» Infrared Kare Lamba
Infrared Square Lamp

Kod Code	Renk Colour	Ölçü (cm) Dim. (cm)
47010009	Beyaz/White	20x20x35
47110009	Siyah/Black	20x20x35

* Fiyata infrared ampül dahildir.
* w/infrared bulb



» Tavan Askı Rayı 3 Lambalı
Hanger Unit (for 3 Lamp)

Kod Code	Yükseklik (cm) Height (cm)	Ölçü (cm) Dim. (cm)
47010007	50 - 100	110

* Ayarlanabilir yükseklik. * Adjustable height



» Tavan Askı Rayı 4 Lambalı
Hanger Unit (for 4 Lamp)

Kod Code	Yükseklik (cm) Height (cm)	Ölçü (cm) Dim. (cm)
47010008	50 - 100	140

* Ayarlanabilir yükseklik. * Adjustable height

- Askı rayı lambaların 100 cm daha aşağıya inmesini sağlar
- Tavanın yüksek olduğu ve yan yana birden fazla ısıtıcı lamba kullanılması gereken durumlarda askı rayı monte edilebilir.

- Lowers infrared lamps 100 cm
- Can be use when ceiling is too high or need to hang more than one infrared lamp

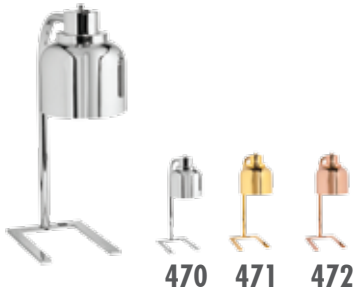

» Infrared Isıtıcı Tekli Lamba (Ayaklı)
Self Standing Single Heat Lamp

Kod Code	Ölçü (cm) Dim. (cm)	Güç Power
47010003	22x28x70	250 W

* Fiyata infrared ampül dahildir. * w/infrared bulb



» Infrared Isıtıcı Çiftli Lamba (Ayaklı)
Self Standing Double Heat Lamp

Kod Code	Ölçü (cm) Dim. (cm)	Güç Power
47010004	50x30x70	2x250 W

* Fiyata infrared ampül dahildir. * w/infrared bulb



» Sıcak Tutucu Isıtıcı Lambalı Set
Heat Lamp w/Warming Plate

Kod Code	Model Model	Ölçü (cm) Dim. (cm)
47013011	1/1	40x60

* Fiyata infrared ampül dahildir. * w/infrared bulb



» Sıcak Tutucu Isıtıcı Lambalı Set
Heat Lamp w/Warming Plate

Kod Code	Model Model	Ölçü (cm) Dim. (cm)
47013021	2/1	71x59

* Fiyata infrared ampül dahildir. * w/infrared bulb

- Komple paslanmaz çelik gövde
- Buz aküsü ile uzun süreli soğuk tutma
- Tüm GN küvetler ile uyumlu
- S/S Body
- Chilling with ice pack
- Suitable for all GN pans



» Soğuk Tutucu Servis Ünitesi
Cold Plate

Kod Code	Model Model	Ölçü (cm) Dim. (cm)
47012011	1/1	40x60
47012021	2/1	71x59

- Komple paslanmaz çelik gövde
- 0°C - 60°C termostat kontrolü
- 200 W ısı ayarı
- S/S Body
- Keeps warm between 0°C - 60°C w/Thermic control
- 200 W



» Sıcak Tutucu Servis Ünitesi
Hot Plate

Kod Code	Model Model	Ölçü (cm) Dim. (cm)
47010011	1/1	40x60
47010021	2/1	71x59



» Carving Station Tek Lambalı
Carving Station Single Lamp

Kod Code	Renk Colour	Ölçü (mm) Dim. (mm)
47113011	Açık/Light	640x830x750
47113111	Koyu/Dark	640x830x750

* Fiyata infrared ampül dahildir. * w/infrared bulb



30-90° Termostat kontrollü
Temperli cam yüzey
Tabla ısıtıcısı 750W
Plexiglass nefeslik
Işıklı on-off switchi
Spiralli ısıtıcı lamba (250W)
Krom kaplı lamba
220-240V

30-90° Digital termostat
Heat retaining tempered glass
Plexiglass sneeze guard
On-off switch
Flexible arm
Chrome coated
220-240 V

173



30-90° Termostat kontrollü
Temperli cam yüzey
Tabla ısıtıcısı 750W
Plexiglass nefeslik
Işıklı on-off switchi
Spiralli ısıtıcı lamba (2x250W)
Krom kaplı lamba
220-240V

30-90° Digital termostat
Heat retaining tempered glass
Plexiglass sneeze guard
On-off switch
Flexible arm
Chrome coated
220-240 V



» Carving Station Çift Lambalı
Carving Station Double Lamp

Kod Code	Renk Colour	Ölçü (mm) Dim. (mm)
47113021	Açık/Light	640x830x750
47113121	Koyu/Dark	640x830x750

* Fiyata infrared ampül dahildir. * w/infrared bulb



» Yükseltici Stand
Elevator Stand

Kod Code	Ölçü (cm) Dim. (cm)
54031717	17x17x17
54030020	20x20x20
54032323	23x23x23
54032626	26x26x26



» Stand

Kod Code	Ölçü (cm) Dim. (cm)
58026040	60x30x4
58026080	60x30x8
58026012	60x30x12



» GN Sogutmalı Set
GN Set w/Ice Boxes

Kod Code	Model Model
54040304	GN 3/4 Set
54040204	GN 2/4 Set
54040001	Buz Aküsü/Ice Box
540	541

174



» Yay Sunumluk Standı
Bowl Display Stand

Kod Code	Ölçü (cm) Dim. (cm)
40341358	3xStand 46x5
40341357	4xStand 57x10,5
40341356	5xStand 67x16
58020909	Melamin Kase 9x9x5,5 Melamine Square Plate 9x9x5,5

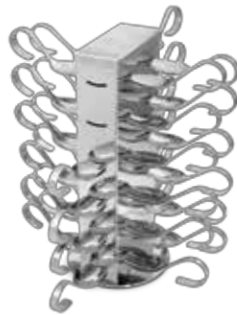

» Sunum Kaşığı Standı
Amuse Bouche Spoon Stand

Kod Code	Ölçü (cm) Dim. (cm)	Kapasite Capacity
40160150	15x34	36 Kaşık/36 Spoons
40160151	30x37	60 Kaşık/60 Spoons

* Fiyata sunum kaşıkları dahil değildir.
*w/o Amuse Bouche Spoons



» Sunum Kaşığı
Amuse Bouche Spoon

Kod Code	Ölçü (mm) Dim. (mm)
40150500	4,5
40150501	6,5

* Fiyatlara yükseltici ayaklar dahildir. * Elevator feet not included the price.



» Katlı Meyvelik Standı
Fruit Stand

Kod Code	Model Model	Ölçü (cm) Dim. (cm)
40290001	2 Katlı / 2 Tiered	17
40290002	3 Katlı / 3 Tiered	28



» Pasta Standı
Cake Stand

Kod Code	Øxh (cm) Øxh (cm)
32502205	22x5
32502405	24x5
32503005	30x5
32503605	36x5
32502210	22x10
32502410	24x10
32503010	30x10
32503610	36x10



» Pasta / Kek Fanusu
Cake Stand w/Cover

Kod Code	Model Model	Ölçü (cm) Dim. (cm)
80010005	Yuvarlak / Round	30,5x30,5x11,5
80010007	Baton / Tangular	39x16,5x12,5



» Yumurta Standı (Isıtmalı)
Egg Stand w/Heater

Kod Code	Ölçü (cm) Dim. (cm)
40200001	26x40x15 (24 Gözlü / 24 Partition)
40200000	32x52x15 (32 Gözlü / 32 Partition)



» Petek Bal Standı
Honey Comb Stand

Kod Code	Ölçü (cm) Dim. (cm)
40340090	23x68x32

* Porselen tabak ve bal kasığı fiyata dahil değildir.
* w/o porcelain plate

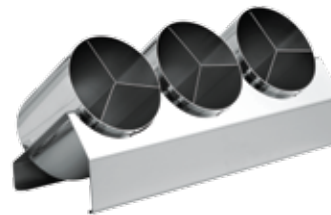

» Çatal Kasık Standı
Cutlery Stand

Kod Code	Ölçü (cm) Dim. (cm)
40160223	43x15x19

*Hazne ölçü: Ø 13, Derinlik: 14
*Chamber: Ø 13, Depth: 14



» Tulip
Tulip

Kod Code	Ölçü (cm) Dim. (cm)
58021075	10x7,5x5
580 581	
 	



» Tulip
Tulip

Kod Code	Ölçü (cm) Dim. (cm)
58021008	
580 581	
 	



» Daisy
Daisy

Kod Code	Ölçü (cm) Dim. (cm)
58020808	8x8x3,3
580 581	
 	

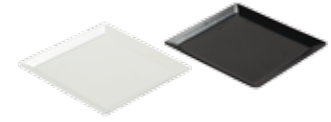

» Leaf
Leaf

Kod Code	Ölçü (cm) Dim. (cm)
58021010	10x10
580 581	
 	

176







» Lily
Lily

Kod Code	Ölçü (cm) Dim. (cm)
58021007	10x7x2,5
580 581	
 	



» Begonia
Begonia

Kod Code	Kapasite Capacity
46010030	30 ml
46011060	60 ml
460 462 465 466	
   	



» Kare Mini Kase
Square Mini Plate

Kod Code	Ölçü (cm) Dim. (cm)
58020909	9x9x5,5



» Kare Kase
Square Plate

Kod Code	Ölçü (cm) Dim. (cm)
58021313	13x13x7



» Yuvarlak Kase
Round Bowl

Kod Code	Ölçü (cm) Dim. (cm)
58021307	Ø 13x7



» Petunia
Petunia

Kod Code	Kapasite (ml) Capacity (ml)
46010040	40
46010055	55



Dalebrook

- » Melamin Kaydırak Sunumluk Beyaz
Melamine Slide Display Spoon

Kod Code	Ölçü (mm) Dim. (mm)
84010016	194x65x55
84110016	194x65x55

840 841
□ ▬

- » Sunum Kasığı
Amuse Bouche Spoon

Kod Code	Ölçü (cm) Dim. (cm)
40150500	4,5
40150501	6,5



Dalebrook

- » Cam Görünümlü Dik Tip Sunumluk
Melamine Glass-like Pente Pot Display

Kod Code	Ölçü (mm) Dim. (mm)	Ad./Koli Pcs/Ctn
84015085	50x85	200

* Paket bazında satılır.



Dalebrook

- » Cam Görünümlü Kase Sunumluk
Melamine Glass-like Bowl Display

Kod Code	Ölçü (mm) Dim. (mm)	Ad./Koli Pcs/Ctn
84046570	65x70	100

* Paket bazında satılır.



Dalebrook

- » Cam Görünümlü Kare Tip Sunumluk
Melamine Glass-like Cubic Bowl Display

Kod Code	Kapasite Capacity	Ad./Koli Pcs/Ctn
84040012	1,2 Lt	60

* Paket bazında satılır.





» Mat Kristal Renkli Açık Büfe Tepsisi
Crystal Matt Display Tray

Kod Code	Ölçü (cm) Dim. (cm)
58013010	300x100x18
58013015	300x150x18
58013020	300x200x18
58013030	300x300x18
58014030	300x400x18



» Desenli Banket Tepsisi
Figured Tray

Kod Code	Ölçü (cm) Dim. (cm)
31611005	530x325



» Desenli Kırılmaz Tepsisi
Patterned Unbreakable Tray

Kod Code	Ölçü (cm) Dim. (cm)
54041525	15x25
54042040	20x40
54043333	33x33
54043353	33x53



» Melamin Sunum Tabak
Melamine GN Display Plate

Kod Code	Model Model	Ölçü (mm) Dim. (mm)
58020101	GN 1/1	530x325
58020204	GN 2/4	530x162



» Melamin Dikdörtgen Sığ Tabak
Melamine Rectangular Shallow Plate

Kod Code	Ölçü (cm) Dim. (cm)
58023620	36x20x4
58025027	50x27x5

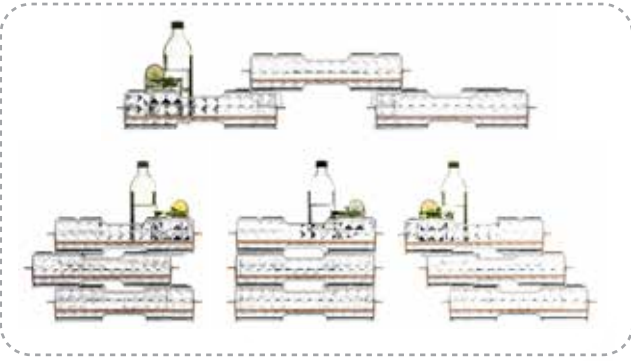

179

» PC Kırılmaz Siyah Tepsi
PC Unbreakable Black Tray

Kod Code	Model Model	Ölçü (mm) Dim. (mm)
39111110	GN 1/1	53x32,5x7



» PC Kırılmaz Seffaf Tepsi
PC Unbreakable Transparent Tray

Kod Code	Model Model	Ölçü (cm) Dim. (cm)
39011110	GN 1/1	53x32,5x7



* GN 1/1 ölçüsünde olduğundan Thermoboxlarla uyumludur
* Trays can be use in Thermoboxes





180



Dalebrook®

» PC Burgu Yükseltici
PC Twist Riser

Kod Code	Ölçü (cm) Dim. (cm)
84010050	5
84010100	10
84010150	15

	
Şeffaf Transparent	Siyah Black
840	841



» Kaymaz Yükseltici
Non-slip Elevator

Kod Code	Ölçü (cm) Dim. (cm)
58022010	10
58022015	15



» Yükseltici
Elevator

Kod Code	Øxh (cm) Øxh (cm)
40100420	20x5
40100430	23x5
40100450	29x5

* Üst üste konularak istenildiği kadar yükseltilebilir.
* Stackable to create a higher elevator.



» Küp Ahsap Yükseltici
Square Wood Riser

Kod Code	Ölçü (cm) Dim. (cm)
69011010	10x10x10
69011515	15x15x15
69012020	20x20x20

» Altıgen Ahsap Yükseltici
Sextagon Wood Riser

Kod Code	Ölçü (cm) Dim. (cm)
69021414	14x10
69021919	19,5x10
69022525	25x10



» Yükseltici Ayaklar
Elevator Feet

Kod Code	Ölçü (cm) Dim. (cm)
40100900	6x6
40100901	11,5x6
40100902	16,5x6



» Makas Yükseltici
Elevator Shears Model

Kod Code	Ölçü (cm) Dim. (cm)
40601811	21x21x7
40601812	21x21x12
40601813	21x21x17

Kayrak Sunumluklar /Slate Display Plates

- Volkanik külle yoğunlaşan taş ısıyı homojen bir şekilde yayar ve yiyecekleri sıcak tutar
- Buzdolabında tutulan kayrak taşı soğuk servisler için ideal
- Kayrak taşının doğallığı, dokusu ve koyurengi sunumlara şıklık katar
- Zeytinyağıyla kolayca parlatılabilir
- Yapışma yapma, kolay temizlenir
- Bulaşık makinesinde yıkanabilir
- Ocak üstü ve mikrodalgada kullanılmaz



- Homogeneous heat distribution keeps foods warm
- For cold serving keep slates in fridge
- Dark colour, pattern and naturality of slate stone makes your presentations elegant
- You can polish your plates with olive oil easily
- Non-stick, easy cleaning
- High-heat resisting
- Dishwasher safe
- Do not use on direct flame or in microwave



» Kayrak Sunum Tabak Natural Kenar
Slate Display Plate Natural Edge

Kod Code	Ölçü (mm) Dim. (mm)
78001200	250x350
78001300	200x300
78011400	100x200
78012400	150x450



» Dikdörtgen Oluklu Sunum Tabak
Slate Rectangular Grooved Display Plate

Kod Code	Ölçü (cm) Dim. (cm)
78002010	12x20
78002512	25x12
78003011	11x30
78003016	16x30
78003020	20x30
78004030	28x40



» Kayrak Kare Oluklu Tabak
Slate Square Grooved Display Plate

Kod Code	Ölçü (mm) Dim. (mm)
78001515	150x150
78002020	200x200
78002525	250x250
78003030	300x300

182





» Kayrak Yuvarlak Tabak Natural Kenar
Slate Round Display Plate Natural Edge

Kod	Ø (cm)
Code	Ø (cm)
78002850	28,5



183

» Kayrak 3 Katlı Sunumluk
Slate Display Stand

Kod	Model	h (cm)	Ø (cm)
Code	Model	h (cm)	Ø (cm)
78000002	2 Katlı/2 Tiered	23	20/25
78000003	3 Katlı/3 Tiered	33	20/25,5/30



Dalebrook

» Mat Melamin Terracotta Çömlek Kase

Matt Melamine Bowl Terracotta

Kod Code	Model Model	Kapasite (Lt) Capacity (Lt)	Ölçü (mm) Dim. (mm)
84111200	1/2	2,5	325x265x70
84111400	1/4	1	265x162x70
84111600	1/6	0,7	176x162x70



Dalebrook

» Mat Melamin Stone Çömlek Kase

Matt Melamine Bowl Stone

Kod Code	Model Model	Kapasite (Lt) Capacity (Lt)	Ölçü (mm) Dim. (mm)
84011200	1/2	2,5	325x265x70
84011400	1/4	1	265x162x70
84011600	1/6	0,7	176x162x70

184



Dalebrook

» Melamin Kavisli Sunum Tepsi Beyaz

Melamine Curved Gastro Display Tray White

Kod Code	Model Model	Ölçü (mm) Dim. (mm)
84212400	2/4	530x162x40
84211200	1/2	265x325x40

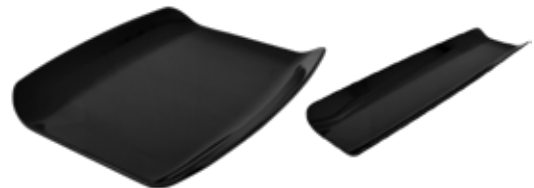

Dalebrook

» Melamin Kavisli Sunum Tepsi Siyah

Melamine Curved Gastro Display Tray Black

Kod Code	Model Model	Ölçü (mm) Dim. (mm)
84121000	2/4	530x162x40
84122000	1/2	265x325x40



Dalebrook

- » Melamin Lotus Sunum Kase Beyaz
Melamine Lotus Bowl White

Kod Code	Kapasite (Lt) Capacity (Lt)	Ölçü (mm) Dim. (mm)
84012500	2,5	250x232x165

Dalebrook

- » Melamin Lotus Sunum Kase Siyah
Melamine Lotus Bowl Black

Kod Code	Kapasite (Lt) Capacity (Lt)	Ölçü (mm) Dim. (mm)
84112500	2,5	250x232x165



Dalebrook

- » Melamin Fıçı Sunum Kase
Melamine Barrel Bowl

Kod Code	Kapasite (Lt) Capacity (Lt)	Øxh (mm) Øxh (mm)
84034500	4,5	Ø 307x90
84038000	8	Ø 307x150

* Kovanın dış ölçüsü : 30x30x19,5 cm
* Outer Bowl Dim.s : Ø 30x19,5 cm





» Çift Cidarlı Derin Tabak
Deep Bowl D/W

Kod Code	Ø xh (cm) Ø xh (cm)
58011208	12x8
58012010	20x10
58012513	25x13



» Çift Cidarlı Konik Tabak
Conical Bowl D/W

Kod Code	Ø xh (cm) Ø xh (cm)
58020030	29,5
58020034	34,5



» Kase
Bowl

Kod Code	Ölçü (cm) Dim. (cm)
58013124	Ø 14x6



» Kayık Tabak
Boat Bowl

Kod Code	Ölçü (cm) Dim. (cm)
58015252	Ø 21x13,2



» Melamin Sunum Tabak
Melamine GN Display Plate

Kod Code	Model Model	Ölçü (mm) Dim. (mm)
58020101	GN 1/1	530x325
58020204	GN 2/4	530x162



» Melamin Dikdörtgen Sığ Tabak
Melamine Rectangular Shallow Plate

Kod Code	Ölçü (cm) Dim. (cm)
58023620	36x20x4
58025027	50x27x5

Açık Büfe Sunum Tabakları / Buffet Display Plates



» Melamin Tabak
Melamine Plate

Kod Code	Ölçü (cm) Dim. (cm)
58022030	30,5
58020035	35,5



» Melamin Kare Sığ Tabak
Melamine Shallow Plate

Kod Code	Ölçü (cm) Dim. (cm)
58023434	34x34x5,5

» Bambu/Melamin Sunum Seti
Bamboo/Melamine Display Set

Kod Code	Kase Ölçü (cm) Bowl Dim. (cm)	Ölçü (cm) Dim. (cm)
58020002	Ø 8,5x6	29x22x3,5
58020001	Ø 13x8,5	40x13x6
58020003	Ø 16x11	49,5x16x8,5



» Melamin Eğik Sunum Tabagı
Melamine Curved Plate

Kod Code	Ölçü (cm) Dim. (cm)
58023029	30x29x14



» Melamin Çukur Sunum Tabagı
Melamine Round Bowl

Kod Code	Dim. (cm) Dim. (cm)
58021609	Ø 16x9
58023613	Ø 36x13



» Melamin Kare Derin Sunum Tabagı
Melamine Square Deep Plate

Kod Code	Ölçü (cm) Dim. (cm)
58021818	18x18x8,5
58023012	30x30x12



» Melamin Dikdörtgen Derin Sunum Tabagı
Melamine Rectahgular Deep Plate

Kod Code	Ölçü (cm) Dim. (cm)
58023525	35x25x7

Melamin Sunum Tabakları / Melamine Display Plates



» GN 1/1 (530x325 mm)

Kod Code	Derinlik (mm) Depth (mm)
58011100	100



» GN 1/2 (325x265 mm)

Kod Code	Derinlik (mm) Depth (mm)
58001220	20
58001240	40
58001265	65
58012100	100



» GN 1/3 (325x176 mm)

Kod Code	Derinlik (mm) Depth (mm)
58001320	20
58001365	65
58013100	100



» GN 1/4 (265x162 mm)

Kod Code	Derinlik (mm) Depth (mm)
58001420	20
58001465	65
58014100	100



» GN 1/6 (176x162 mm)

Kod Code	Derinlik (mm) Depth (mm)
58001665	65
58016100	100



» GN 1/9 (176x108 mm)

Kod Code	Derinlik (mm) Depth (mm)
58001965	65



* Tüm melamin GN kütetlerin altında kaymayı önleyici 4 adet silikon vardır.
*Non-slip silicones on the bottom corners.

- %100 ahşap görümlü
- Bakteri barındırmaz
- +85°C / -40°C arası ısı dayanıklılığı
- Bulaşık makinesinde yıkanabilir
- Esnek malzemeden imal edilmiştir
- %100 wood view
- Unbacterialised
- Heat intensive and endurance up to +85 and -40+85°C / -40°C
- Dishwasher safe
- Manufactured from elastic materials



» Derin Kase
Deep Bowl

Kod Code	Ø (cm) Ø (cm)
80011012	12,5
80011016	16
80011020	20
80011024	24



» Kare Derin Tabak
Square Deep Bowl

Kod Code	Ölçü (cm) Dim. (cm)
80010100	10x10x3,5
80010111	12,5x12,5x6
80010112	19,5x19,5x9,5
80010113	24x24x10,5
80010114	29x29x11
80010115	36x36x12



» Üçgen Derin Tabak
Triangle Deep Bowl

Kod Code	Ölçü (cm) Dim. (cm)
80011100	10x3,5
80011111	12x6
80011112	19,5x10
80011113	24x10,5
80011114	29x11
80011115	36x12

189



» Oval Tabak
Eliptic Bowl

Kod Code	Ölçü (cm) Dim. (cm)
80012230	22x30x8
80013624	36x24x8,5
80012740	27x40x8,5



» Yuvarlak Tabak
Round Bowl

Kod Code	Ölçü (cm) Dim. (cm)
80010015	Ø 16x4
80010020	Ø 21x5,5
80010025	Ø 26x7
80010030	Ø 30x8



» Yaprak Tepsi
Leaf Display Tray

Kod Code	Ölçü (cm) Dim. (cm)
80010211	25x45x3
80010212	33x57x3



» Elit Tepsi
Elite Tray

Kod Code	Ölçü (cm) Dim. (cm)
80010133	31x39
80010134	35x42



» Sunum Tepsi
Display Tray

Kod Code	Ölçü (cm) Dim. (cm)
80010208	9x35,5x4
80010209	23x46x5
80010210	33x55x5



» Kare Tabak
Square Bowl

Kod Code	Ölçü (cm) Dim. (cm)
80012323	23x23x7
80012828	28x28x7,5

190



» Meze Kuveti
Appetizer Pan

Kod Code	Ölçü (cm) Dim. (cm)
80012818	28x18,5x4
80013323	33x23x4
80013826	38x26x4





» Bölmeli
Partitioned Basket

Kod Code	Ölçü (cm) Dim. (cm)
57025232	52.5x32.5x8



» Büyük Oval
Oval Open Buffet Basket

Kod Code	Ölçü (cm) Dim. (cm)
57026144	61x44.5x14
57027257	72.5x57x14

- Koku yapmaz
- Neme karşı dayanıklıdır
- Bulaşık makinasında yıkanabilir
- Işığa dayanıklıdır, solmaz
- Zehirli madde içermez

- Odorless
- Humid free
- Dishwasher safe
- Colour-fast
- Toxic free



» Uzun Teshir
Long Display Basket

Kod Code	Ölçü (cm) Dim. (cm)
57022441	24x41x5x15



» Geniş Teshir
Wide Display Basket

Kod Code	Ölçü (cm) Dim. (cm)
57024530	45x30x5x11,5
57026145	61x45x5x12



» Derin
Deep Basket

Kod Code	Ölçü (cm) Dim. (cm)
57024030	40x30x18
57026040	60x40x18

191



» Baget
Baguette Basket

Kod Code	Ölçü (cm) Dim. (cm)
57023328	33x28x45



» Baget Ekmeklik
Baguette Basket (S/S)

Kod Code	Ölçü (cm) Dim. (cm)
40100131	Ø 27x31
40100132	Ø 27x40



» Ekmek Sepeti
Bread Basket (S/S)

Kod Code	Ölçü (cm) Dim. (cm)
40101151	21x17x6
40101152	30x21x6
40101153	35x23,5x10
40101154	45x32x10

* Ürünler plastik değildir.
* Products are not plastic.



Restaurant Table-Top





» Kayrak Yuvarlak Tabak
Slate Round Plate

Kod Code	Ø (cm) Ø (cm)
78002850	28,5



- Volkanik külle yoğunlaşan taş ısıyı homojen bir şekilde yayar ve yiyeceklerisıcak tutar
- Buzdolabında tutulan kayrak taşı soğuk servisler için ideal
- Kayrak taşının doğallığı, dokusu ve koyurengi sunumlara şıklık katar
- Zeytinyağıyla kolayca parlatılabilir
- Yapışma yapma, kolay temizlenir
- Bulaşık makinesinde yıkanabilir
- Ocak üstü ve mikrodalgada kullanılmaz
- *Homogeneous heat distribution keeps foods warm*
- *For cold serving keep slates in fridge*
- *Dark colour, pattern and naturality of slate stone makes your presentations elegant*
- *You can polish your plates with olive oil easily*
- *Non-stick, easy cleaning*
- *High-heat resisting*
- *Dishwasher safe*
- *Do not use on direct flame or in microwave*



» Kayrak Sunum Tabak Natural Kenar
Slate Display Plate Natural Edge

Kod Code	Ölçü (mm) Dim. (mm)
78001200	250x350
78001300	200x300
78011400	100x200
78012400	150x450



» Dikdörtgen Oluklu Sunum Tabak
Slate Rectangular Grooved Display Plate

Kod Code	Ölçü (cm) Dim. (cm)
78002010	12x20
78002512	25x12
78003011	11x30
78003016	16x30
78003020	20x30
78004030	28x40



» Kayrak Kare Tabak
Slate Square Plate

Kod Code	Ölçü (mm) Dim. (mm)
78001515	150x150
78002020	200x200
78002525	250x250
78003030	300x300



» Kayrak 2 Katlı Sunumluk
Slate Display Stand 2 Tiered



Kod Code	h (cm) h (cm)	Ø (cm) Ø (cm)
78000002	23	20/25

» Kayrak 3 Katlı Sunumluk
Slate Display Stand 3 Tiered



Kod Code	h (cm) h (cm)	Ø (cm) Ø (cm)
78000003	33	20/25,5/30



196



» Boga Steak Tahtası (Ireko)
Bull Steak Display (Ireko)

Kod Code	Ölçü (cm) Dim. (cm)
69012637	26x37



» Saplı Steak Tahtası (Ireko)
Display w/handle (Ireko)

Kod Code	Ölçü (cm) Dim. (cm)
69012043	20x43
69012547	25x47
69013242	32x42



» Klasik Steak Tahtası (Ireko)
Classic Display (Ireko)

Kod Code	Ölçü (cm) Dim. (cm)
69012335	23x35
69012538	25,5x38,5



» Boga Steak Tahtası (Kayın)
Bull Steak Display (Beachwood)

Kod Code	Ölçü (cm) Dim. (cm)
69022637	26x37



» Saplı Steak Tahtası (Kayın)
Display w/handle (Beachwood)

Kod Code	Ölçü (cm) Dim. (cm)
69022043	20x43
69022547	25x47
69023242	32x42



» Klasik Steak Tahtası (Kayın)
Classic Display (Beachwood)

Kod Code	Ölçü (cm) Dim. (cm)
69022335	23x35
69022538	25,5x38,5



» Geometrik Sunumluk (Ireko)
Geometrical Display (Iroko)

Kod Code	Ölçü (cm) Dim. (cm)
69012038	20x38



» Saplı Peynir Sunumluk (Ireko)
Cheese Display w/handle (Iroko)

Kod Code	Ölçü (cm) Dim. (cm)
69011547	15x47



» Klasik Peynir Sunumluk (Ireko)
Classic Cheese Display (Iroko)

Kod Code	Ölçü (cm) Dim. (cm)
69011635	16x35



» Geometrik Sunumluk (Kayın)
Geometrical Display (Beachwood)

Kod Code	Ölçü (cm) Dim. (cm)
69112038	20x38



» Saplı Peynir Sunumluk (Kayın)
Cheese Display w/handle (Beachwood)

Kod Code	Ölçü (cm) Dim. (cm)
69021547	15x47



» Klasik Peynir Sunumluk (Kayın)
Classic Cheese Display (Beachwood)

Kod Code	Ölçü (cm) Dim. (cm)
69021635	16x35



» Saplı Pizza Sunumluk (Ireko)
Pizza Display w/handle (Iroko)

Kod Code	Ø (cm) Ø (cm)
69010028	28



» Yuvarlak Sunumluk (Ireko)
Round Display (Iroko)

Kod Code	Ø (cm) Ø (cm)
69011028	28



» Elips Sunumluk (Ireko)
Elips Display (Iroko)

Kod Code	Ölçü (cm) Dim. (cm)
69012745	17x45



» Saplı Pizza Sunumluk (Kayın)
Pizza Display w/handle (Beachwood)

Kod Code	Ø (cm) Ø (cm)
69020028	28



» Yuvarlak Sunumluk (Kayın)
Round Display (Beachwood)

Kod Code	Ø (cm) Ø (cm)
69021028	28



» Elips Sunumluk (Kayın)
Elips Display (Beachwood)

Kod Code	Ölçü (cm) Dim. (cm)
69022745	17x45



» PC Düz Tabak
PC Flat Plate

Kod Code	Ø (cm) Ø (cm)
46040013	13
46040015	15
46040017	17
46040019	19
46040021	21
46040023	23
46040025	25
46040028	28



» PC Oluklu Tabak
PC Soup Plate

Kod Code	Ø (cm) Ø (cm)
46030019	19
46030021	21



» PC Çukur Tabak
PC Ribbed Plate

Kod Code	Ø (cm) Ø (cm)
46050017	17
46050018	18,5



» PC Çorba Kasesi
PC Bowl

Kod Code	Ø (cm) Ø (cm)
46050012	12



» PC Kare Kayık Tabak
PC Appetizer Plate

Kod Code	Ölçü (cm) Dim. (cm)
46020210	12
46020014	14
46020017	17
46020020	20



» PC Kayık Tabak
PC Shallow Platter

Kod Code	Ø (cm) Ø (cm)
46011114	14
46010024	24
46010029	29
46010034	34

marlux

MADE IN
FRANCE

NEW

- Monoblok gövde çatlamalara ve kırılmalara karşı dayanıklı
- Öğütme boyutu değirmenin üst kısmındaki topuzda ayarlanır. Ne kadar sıkarsanız o kadar ince öğütür. Eğer topuzu gevşetirseniz öğütme daha iri taneler elde edersiniz. En iyi öğütme işlemi gerçekleştirmek için değirmeni daima aynı yönde çevirin.
- Karabiber için yüksek kaliteli kesilmiş ve sertleştirilmiş çelik mekanizma değirmenler.
- Tuz değirmenleri için paslanmaz çelik mekanizma. Çelik mekanizmalar üretim hatalarına karşı ömür boyu garantilidir. Yanlış kullanımdan kaynaklanan zararları kapsamaz.
- Akdeniz gibi nemli bölgelerde paslanmayı önlemek için seramik mekanizma. Seramik Mekanizmalı değirmenler için garanti süresi üç yıldır
- Çelik mekanizmalı bir karabiber değirmeni asla tuz ile doldurulmamalıdır. Tuz aşırındırıcıdır ve mekanizmaya geri dönülmez bir hasar verir. Tuz değirmeni kendine ait paslanmaz çelik mekanizmaya sahiptir.

- Monoblock body against cracking and breaking
- The grinding size is set by adjusting the knob on the top of the mill : the more you tighten it up, the finer the grinding (spicy but less flavored). If you loosen it, the coarser the grinding is (flavored but less spicy). Always rotate the mill top in the same direction to get the best grinding
- These mills made of wood are available with different mechanisms:
- With high quality cut and hardened steel mechanism for pepper mills.
- With stainless steel mechanism for salt mills. These steel mechanism are lifetime guaranteed against manufacturing defects, within a normal use and does not cover damages caused by shock or misuse.
- With a ceramic mechanism for spice mills (coarse white salt, coarse sea salt, mixed peppercorns, herbes de Provence). These mills are guaranteed against manufacturing defects for three years. The upper knob sets grinding size. These mills are delivered empty.
- The pepper mill with a steel mechanism must never be filled with salt : the salt is corrosive and will irreversibly damage the mechanism. The salt mill has its own mechanism made of a s/s which has been specially treated against salt corrosion.

NEW



» Java Dark Karabiber Değirmeni
Java Dark Pepper Mill

Kod Code	Ölçü (cm) Dim. (cm)
66022214	14
66022221	21
66022225	25
66022230	30
66022240	40
66022280	80

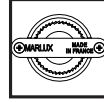

200



Çelik Karabiber Değirmeni Mekanizması
Steel Pepper Mill Mechanism



Paslanmaz Çelik Tuz Değirmeni Mekanizması
S/S Salt Mill Mechanism



Seramik Değirmeni Mekanizması
Ceramic Mill Mechanism



» Java Natural Karabiber Değirmeni
Java Natural Pepper Mill

Kod Code	Ölçü (cm) Dim. (cm)
66022114	14
66022121	21
66022125	25
66022130	30
66022140	40
66022180	80





NEW

Seramik Mekanizma
Ceramic Mechanism



» Polka Matte S/S
Polka Matte S/S

Kod Code	Model Model	Ölçü (cm) Dim. (cm)
66041014	Tuz /Salt	14
66042014	Karabiber / Pepper	14

Seramik Mekanizma
Ceramic Mechanism



» Polka Matte S/S
Polka Matte S/S

Kod Code	Model Model	Ölçü (cm) Dim. (cm)
66041025	Tuz /Salt	25
66042025	Karabiber / Pepper	25

S/S Mekanizma
S/S Mechanism



Çelik Mekanizma
Steel Mechanism



» Madison Inox
Madison Inox

Kod Code	Model Model	Ölçü (cm) Dim. (cm)
66061014	Tuz /Salt	14
66062014	Karabiber / Pepper	14

Seramik Mekanizma
Ceramic Mechanism



» Hip Hop Dark
Hip Hop Dark

Kod Code	Model Model	Ölçü (cm) Dim. (cm)
66031211	Tuz /Salt	11
66032211	Karabiber / Pepper	11

S/S Mekanizma
S/S MechanismÇelik Mekanizma
Steel Mechanism

» Rumba
Rumba

Kod Code	Model Model	Ölçü (cm) Dim. (cm)
66051320	Tuz /Salt	20
66052320	Karabiber / Pepper	20



202

S/S Mekanizma
S/S MechanismÇelik Mekanizma
Steel Mechanism

» Paso Dark
Paso Dark

Kod Code	Model Model	Ölçü (cm) Dim. (cm)
66011210	Tuz /Salt	10
66012210	Karabiber / Pepper	10

S/S Mekanizma
S/S MechanismÇelik Mekanizma
Steel Mechanism

» Paso Natural
Paso Natural

Kod Code	Model Model	Ölçü (cm) Dim. (cm)
66011110	Tuz /Salt	10
66012110	Karabiber / Pepper	10



» Ahsap Degirmen (Çelik Bıçaklı)
Rubber Wood (S/S Grinder)

Kod Code	Model Model	Ölçü (cm) Dim. (cm)
53011013	Tuzluk / Salt Sprinkler	13
53012013	Değirmen / Pepper Mill	13
53011021	Değirmen / Pepper Mill	21
53011031	Değirmen / Pepper Mill	31
53011041	Değirmen / Pepper Mill	41
53011046	Değirmen / Pepper Mill	46



» Tuzluk & Biberlik Set
Salt & Pepper Set

Kod Code	Ölçü (cm) Dim. (cm)
62010034	11



» Gondol Set
Gondol Set

Kod Code
35970000



» Sütun Set
Pillar Set

Kod Code	Ölçü (cm) Dim. (cm)
53040720	8



» Seramik Set
Ceramic Set

Kod Code	Model Model	Ölçü (cm) Dim. (cm)
53043122	Tuzluk&Karabiber / Salt&Pepper	Ø 6,5x7
53040225	Kürdanlık / Toothpick	Ø 4,5x8



» Polikarbonat Tuzluk&Biberlik **plast|port®**
PC Salt & Pepper Set

Kod Code	Model Model
46010070	Tuzluk / Salt Sprinkler
46010071	Karabiberlik / Pepper Sprinkler

Yağlık & Sirkelik / Condiment Sets



» Parmesan Peynirlik
Parmesan Sprinkler

Kod Code	Ölçü (cm) Dim. (cm)
53048123	Ø 8x12



» Ahsap Sos Kutusu
Wooden Sauce Box

Kod Code	Ölçü (cm) Dim. (cm)
69011422	14x22
69011527	15x27



» Yağlık & Sirkelik
Oil & Vinegar Stand

Kod Code	Kapasite Capacity
53033002	100 mlx2

204



» Yağlık & Sirkelik
Oil & Vinegar Stand

Kod Code	Kapasite Capacity
53052250	2x250 ml



» Yağlık & Sirkelik
Oil & Vinegar Stand

Kod Code	Kapasite Capacity
53053250	3x250 ml



» Yağlık & Sirkelik
Oil & Vinegar Stand

Kod Code	Kapasite Capacity
53054250	2x250 ml+2x150 ml



» Reçel & Baharat Set
Jar Set

Kod Code	Ölçü (cm) Dim. (cm)
53053110	3x110 ml



» PC Sekerlik / Baharatlık
PC Sugar Bowl/ Cruet

Kod Code	Model Model	Ölçü (cm) Dim. (cm)
46010004	Şekerlik / Sugar Bowl	12
46010006	Baharatlık / Cruet	

plast|port®



» Sunum Sandık
Wooden Display Box

Kod Code	Ölçü (cm) Dim. (cm)
69001417	14x17

6900 **6901**
İreko/Iroko Kayın/Beachwood



» Sunum Sandık Derin
Wooden Deep Display Box

Kod Code	Ölçü (cm) Dim. (cm)
69002030	20x30

6900 **6901**
İreko/Iroko Kayın/Beachwood



» Tost Sunumluk 6 Dilim
Toast Rack 6 Slices

Kod Code	Ölçü (cm) Dim. (cm)
56036127	15x7,5x11,5



» Bakır Sunum Kova
Copper Plated Display Bucket

Kod Code	Ölçü (cm) Dim. (cm)
56130009	9
56130012	12



» Sunum Sepet
Display Basket

Kod Code	Ölçü (cm) Dim. (cm)
56031009	10,5x9



» Dikdörtgen Sunum Sepeti
Rectangular Display Basket

Kod Code	Ölçü (cm) Dim. (cm)
56032110	21x10x3,5



» Konik Sunumluk
Conical Snack Holder

Kod Code	Ölçü (cm) Dim. (cm)
60011001	18x10,4



» Sunum Mini Tava
Mini Display Pan

Kod Code	Ölçü (cm) Dim. (cm)
56030014	14,5x9,5x4,5

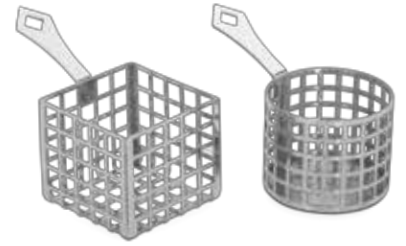

» Patates Sepeti
Miniature French Fries Basket

Kod Code	Ölçü (cm) Dim. (cm)
40160501	7,5x7,5x6
40160502	Ø 7,5x6



» Kırıntı Küregi
Table Crumbler

Kod Code
44010001



» Peçetelik
Napkin Holder

Kod Code	Ölçü (cm) Dim. (cm)
56012111	15x3x10



» Peçetelik
Napkin Holder

Kod Code	Ölçü (cm) Dim. (cm)
56011208	18,5x4,5x10,5



» Mumluk
Candle Holder

Kod Code	Ölçü (cm) Dim. (cm)
56016073	8,5x8,5x8,5
56016075	9x9x14



» Seramik Dondurmalık
Ceramic Ice Cream Cup

Kod Code	Ölçü (cm) Dim. (cm)
53040103	Ø 9x13,5



» Seramik Mumluk/Peçetelik
Ceramic Candle/Napkin Holder

Kod Code	Model Model	Dim. (cm) Dim. (cm)
53040222	Mumluk / Candle Holder	Ø 11,5x11,5
53040226	Peçeteli / Napkin Holder	Ø 17x9



» Tabak Kapagı
Plate Cover

Kod Code	Ø (cm) Ø (cm)
56011270	27
56011300	30



» Sunum Kapagı
Display Cover

Kod Code	Ø (cm) Ø (cm)
40335005	20,5
40335006	23
40335007	26



» Sos Teknesi
Gravy Boat

Kod Code	Kapasite (ml) Capacity (ml)
58010727	150
58010728	300



» Delikli Kase
Perforated Bowl

Kod Code	Ölçü (cm) Dim. (cm)
57012110	Ø 17,5
57012111	Ø 20,5
57012112	Ø 22,5



» Kayık Kase
Boat Bowl

Kod Code	Ölçü (cm) Dim. (cm)
58015252	Ø 21x13,2



» Kase
Bowl

Kod Code	Ölçü (cm) Dim. (cm)
58013124	Ø 14x6



» Ayaklı Kadeh (Dondurmalık)
Ice Cream Cup

Kod Code	Ölçü (cm) Dim. (cm)
35201000	6,5
35202000	8
35203000	9
35204000	10



» Dondurmalık
Ice Cream Cup

Kod Code	Ölçü (cm) Dim. (cm)
35200001	8
35200002	8,5
35200003	9,5

207



» Seramik Kase
Ceramic Bowl

Kod Code	Ölçü (cm) Dim. (cm)
57011711	Ø 22x10



Ekmek Sepetleri / Bread Baskets



» Çelik Ekmek Sepeti
Bread Basket (S/S)

Kod Code	Ölçü (cm) Dim. (cm)
40101151	21x17x6
40101152	30x21x6



» Çelik Tel Ekmek Sepeti
Bread/Fruit Basket (S/S)

Kod Code	Ölçü (cm) Dim. (cm)
57012210	Ø 20x10



» Rattan Yuvarlak Ekmek Sepeti
Round Rattan Basket

Kod Code	Ölçü (cm) Dim. (cm)
57022008	20,5x7,5
57022308	23x7,5
57022508	25x7,5

* Plastik değildir.
* Product is not plastic.



» Rattan Oval Ekmek Sepeti
Oval Rattan Basket

Kod Code	Ölçü (cm) Dim. (cm)
57022216	21.5x15x6
57022416	24x16,5x6
57022618	26x18x6
57022918	29x18x6

* Plastik değildir.
* Product is not plastic.



» Köseli Ekmek Sepeti
Rectangular Basket

Kod Code	Ölçü (cm) Dim. (cm)
80011118	14,5x21x5
80011119	18,5x25,5x7



» Oval Ekmek Sepeti
Oval Basket

Kod Code	Ölçü (cm) Dim. (cm)
80011116	15x20x5
80011117	21x30x7,5



» Yuvarlak Havuzlu
Round Ashtray w/Cover

Kod
Code
35940000



» Kare Havuzlu
Square Ashtray w/Cover

Kod
Code
35930000



» Havuzlu Rüzgarlıklılı
Wind Protected Ashtray

Kod Code	Model Model
43040011	Küçük / Small
43040010	Büyük / Big



» Döküm
Casted Black Ashtray

Kod Code	Model Model	Ölçü (cm) Dim. (cm)
43040004	Kare/ Square	8x8x3,5
43040005	Yuvarlak / Round	Ø 9,3x4



» Döküm
Casted Ashtray

Kod Code	Model Model	Ölçü (cm) Dim. (cm)
40350013	Kare/ Square	8x8x3,5
43040001	Yuvarlak / Round	Ø 9,3x4



» Döküm Bronz
Casted Bronze Ashtray

Kod Code	Model Model	Ölçü (cm) Dim. (cm)
43040002	Kare/ Square	8x8x3,5
43040003	Yuvarlak / Round	Ø 9,3x4



» Ayaklı Küllük Stand
Ashtray Stand

Kod Code	h (cm) h (cm)
40010004	76



» Dış Mekan Küllüğü
Outdoor Ashtray

Kod Code	Ölçü (cm) Dim. (cm)
48060002	40x99





İçecek

Beverage

- Zeminden pervane karıştırıcı
 - Hermetik kompresör
 - Hava soğutmalı kondenser
 - Polikarbon konteyner
 - Paslanmaz çelik gövde
- Designed to cool all non-carbonated drinks
- Easy to use and versatile
- w/ Stirring paddle
- Quick and easy cleaning
- Hermetic compressor
- Air cooled condenser
- Shockproof polycarbonate food grade bowls
- S/S structure



ugolini

» Serbetlik
Juice Cooler

COMPACT 8/2

Kod Code	Kapasite (lt) Capacity (lt)	Ölçü (cm) Dim. (cm)
59040016	2x8	25x40x63

212

- Pompa püskürtmeli (şelale)
 - Hermetik kompresör
 - Hava soğutmalı kondenser
 - Polikarbon konteyner
 - Paslanmaz çelik gövde
- Designed to cool all types of drinks (Natural fruit juices, coffee and tea, almond milk etc.
- Easy to use and versatile
- w/ Fountain pump
- Quick and easy cleaning
- Hermetic compressor
- Air cooled condenser
- Shockproof polycarbonate food grade bowls
- S/S structure



ugolini

» Serbetlik
Juice Cooler

DELUX

Kod Code	Kapasite (lt) Capacity (lt)	Ölçü (cm) Dim. (cm)
59040012	12	18x47x57
59040024	12x2	36x47x57

ugolini



- Dijital termometre
- Hava soğutmalı kondenser
- Polikarbon konteyner
- Paslanmaz çelik gövde
- 220 V
- Kolay temizlenebilir
- *Designed for all natural fruit juices*
- *Designed to stir the juice even and perfect*
- *Easy to use and versatile*
- *w/ Stirring paddle*
- *w/Digital thermometer*
- *Quick and easy cleaning*
- *Hermetic compressor*
- *Air cooled condenser*
- *Shockproof polycarbonate food grade bowls*
- *S/S structure*
- *220 V*

A 19

» Ayrın & Serbet Soğutucu
Cooler & Dispenser

Kod Code	Kapasite (lt) Capacity (lt)	Ölçü (cm) Dim. (cm)
59040019	19	35x38x71,3

213

ugolini



- Çift termostat
- Polikarbon konteyner
- Siyah boyalı gövde
- Geniş ağızlı musluklu
- 220 V, 1300 W
- Kolay temizlenebilir
- *Designed to mix hot chocolate and all thick drinks*
- *Easy to use and versatile*
- *w/ Stirring paddle*
- *w/Double thermostate*
- *Quick and easy cleaning*
- *Shockproof polycarbonate food grade bowls*
- *S/S structure*
- *220 V - 1300 Watt*

Delice

» Sıcak Çikolata / Şahlep Makinesi
Hot Chocolate Dispenser

Kod Code	Kapasite (lt) Capacity (lt)	Ölçü (cm) Dim. (cm)
59040005	5	26x32x49,5

- Manyetik sistem karıştırıcı
- Hermetik kompresör, arıza göstergesi
- Hava soğutmalı kondenser
- Polikarbon konteyner
- Paslanmaz çelik gövde

- Designed to make and dispense granitas & iced drinks
- Magnetic system stirrer
- Excl. patented magnetic transmission system
- Easy to use and versatile
- Quick and easy cleaning
- Hermetic compressor
- Air cooled condenser
- Shockproof polycarbonate food grade bowls
- S/S structure



ugolini

Minigel

» Dondurma Makinesi

Granita & Ice Slush Dispenser

Kod Code	Kapasite (lt) Capacity (lt)	Ölçü (cm) Dim. (cm)
59040006	6	19,5x48x61,5

214

- Manyetik sistem karıştırıcı
- Hermetik kompresör, arıza göstergesi
- Hava soğutmalı kondenser
- Polikarbon konteyner, aydınlatmalı
- Paslanmaz çelik gövde

- Designed to make and dispense granitas & iced drinks
- Magnetic system stirrer
- Excl. patented magnetic transmission system
- Easy to use and versatile
- Quick and easy cleaning
- Hermetic compressor
- Air cooled condenser
- Shockproof polycarbonate food grade bowls
- S/S structure



ugolini

MT 2

» Buzlu İçecek Makinesi / Ice Slush

Ice Slush Dispenser

Kod Code	Kapasite (lt) Capacity (lt)	Ölçü (cm) Dim. (cm)
59040020	2x10	36x47x69



» Blender (Kare Hazneli)
Blender (Square Jug)

Kod
Code
63010015



» Blender (Ses Geçirmez Kare Hazneli)
Blender (Square Jug w/Sound Enclosure)

Kod
Code
63020015



» Blender (Ses Geçirmez Yuvarlak Hazneli)
Blender (Round Jug w/Sound Enclosure)

Kod
Code
63010041



» Blender Yuvarlak Hazneli
Blender Round Jug

Kod
Code
63010014



» Blender Kare Hazneli
Blender Square Jug

Kod
Code
63010040



» Blender
Blender

Kod
Code
63010013



» Narenciye Sıkacağı
Citrus Juicer

Kod Code	Model Model
63010016	Kapaksız / w/o Lid
63010017	Kapaklı / w/Lid



» Buz Kırıcı
Ice Crusher

Kod Code
63010039



» Buz Kırıcı
Ice Crusher

Kod Code
63010018

216



» İçecek Mikseri
Beverage Mixer

Kod Code
63010011



» Çay Otomatı
Tea Maker

Kod Code	Model Model	Kapasite (lt) Capacity (lt)
41011040	40 Bardak/Glasses	6
41011060	60 Bardak/Glasses	7,5
41011090	80 Bardak/Glasses	9
41011120	120 Bardak/Glasses	12
41011160	160 Bardak/Glasses	16
41011250	250 Bardak/Glasses	22
41101450	400 Bardak/Glasses	38



» Portakal/Nar Sıkma
Orange/Pomegranate Juicer

Kod Code	Model Model
41030002	Portakal/ Orange
41030012	Portakal & Nar / Orange & Pomegranate



Büyük Özel Buz
Large Special Ice
Code: LSI
18 gr

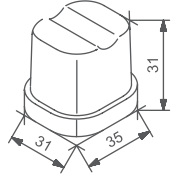

217



» Buz Makinesi 25
Ice Machine 25

Kod
Code
72010025

Kapasite (kg / 24h) / Capacity (kg / 24h)	22
Depolama Kapasitesi (kg) / Storage Capacity (kg)	4
Buz Tipi / Ice Type	LSI
Soğutma Sistemi / Cooling System	Air
İklim Sınıfı / Climate Class	T
Soğutucu Gaz / Refrigerant Gas	R134a
Voltaj / Voltage	230V-50Hz
Ölçüler / Dimensions (w x d x h)	355x404x590



» Buz Makinesi 35
Ice Machine 35

Kod
Code
72010035

Kapasite / Capacity (kg / 24h)	32
Depolama Kapasitesi (kg) / Storage Capacity (kg)	16
Buz Tipi / Ice Type	LSI
Soğutma Sistemi / Cooling System	Air
İklim Sınıfı / Climate Class	T
Soğutucu Gaz / Refrigerant Gas	R134a
Voltaj / Voltage	230V-50Hz
Ölçüler / Dimensions (w x d x h)	500x580x690



» Buz Makinesi 50
Ice Machine 50

Kod
Code
72010050

Kapasite / Capacity (kg / 24h)	47
Depolama Kapasitesi (kg) / Storage Capacity (kg)	28
Buz Tipi / Ice Type	LSI
Soğutma Sistemi / Cooling System	Air
İklim Sınıfı / Climate Class	T
Soğutucu Gaz / Refrigerant Gas	R134a
Voltaj / Voltage	230V-50Hz
Ölçüler / Dimensions (w x d x h)	500x580x800

Kendinden Buz Hazneli Kapak
Lid has Self Ice Store



» Carina İçecek Dispenseri
Carina Juice Dispenser

Kod	(Lt)
Code	(Lt)
55011112	7,7

» Carina Kahve Dispenseri
Carina Coffee Dispenser

Kod	(Lt)
Code	(Lt)
55011019	7,7

» Carina Süt Dispenseri
Carina Milk Dispenser

Kod	(Lt)
Code	(Lt)
55011212	6,4

219



» İçecek Dispenseri
Juice Dispenser

Kod	(Lt)
Code	(Lt)
55011277	7,7

» İçecek Dispenseri
Juice Dispenser

Kod	(Lt)
Code	(Lt)
55011278	2x7,7

» İçecek Dispenseri
Juice Dispenser

Kod	(Lt)
Code	(Lt)
55011279	3x7,7



» Lux İçecek Dispenseri
Lux Juice Dispenser

Kod Code	Lt
54012112	12



» Lux Kahve Dispenseri
Lux Coffee Dispenser

Kod Code	Lt
54012212	12



* Ürün standsız da kullanılabilir.
* Can be use w/o wire stand

» Ice Tea Dispenseri (Cam)
Ice Tea Dispenser (Glass)

Kod Code	Lt
59057900	7,9



» Premium İçecek Dispenseri
Premium Juice Dispenser

Kod Code	Lt
54011112	12



» Premium Kahve Dispenseri
Premium Coffee Dispenser

Kod Code	Lt
59011019	19



• Kendinden buz hazneli kapak
• Lid has self ice store

» Lux Süt Dispenseri
Lux Milk Can

Kod Code	Lt
54011212	6



» Modern İçecek Dispenseri
Modern Juice Dispenser

Kod	Lt
Code	Lt
74011112	12



» Modern Kahve Dispenseri
Modern Coffee Dispenser

Kod	Lt
Code	Lt
74011000	10



» Meyve Suyu Dispenseri Tekli
Single Juice Dispenser

Kod	Ölçü (cm)	Lt
Code	Dim. (cm)	Lt
59039021	37x23x60	7



» Meyve Suyu Dispenseri Çiftli
Double Juice Dispenser

Kod	Ölçü (cm)	Lt
Code	Dim. (cm)	Lt
59039022	37x45x69	14

İçecek Ekipmanları / Beverage Servers



» Lux Termos (Switch Kapak)
Beverage Server S/S Insulated

Kod Code	Kapasite (lt) Capacity (lt)
51019210	1,00
51019215	1,50
51019220	2,00



» Termos (İç-Dış S/S)
Beverage Server S/S Insulated

Kod Code	Kapasite (lt) Capacity (lt)
51021310	1,00
51021315	1,50
51021320	2,00



» Sürahi
Water Jug

Kod Code	Ölçü (cm) Dim. (cm)
60011431	Ø 85x26

222



» PC Sürahi
PC Jug

Kod Code	Kapasite (lt) Capacity (lt)
60020018	1,8 Lt



» French Press
French Press

Kod Code	ml ml
58060350	350
58060600	600



» İçecek Kupası
Glass Mug

Kod Code	ml ml
59050001	550



» Süt Potu
Tea/Milk Pot

Kod Code	Model Model	Kapasite (lt) Capacity (lt)
55016202	Çay Potu / Tea Pot	2 cc
55016204	Çay Potu / Tea Pot	4 cc
55016215	Süt Potu / Milk Pot	150 ml
62010150	Süt Potu / Milk Pot	150 ml
62010350	Süt Potu / Milk Pot	350 ml



» Poşet Çay Standı / Mini Tabak
Acrylic Sugar Caddy / Mini Tea Bag Plate

Kod Code	Model Model
40202250	Mini Tabak
62030003	Mini Tea Bag Plate
	Poşet Çay Standı Acrylic Sugar Caddy



» Bardak
Mug S/S

Kod Code
36702052



» Bardak

Glass

Kod Code	ml ml	Ad./Koli Pcs/Ctn
46010250	250	50
46010300	300	50
46010400	400	50

» Kumlu Bardak

Sandy Surface Glass

Kod Code	ml ml	Ad./Koli Pcs/Ctn
46011250	250	400
46011400	400	400

» Prizma/Shot Bardak

Prizma/Shot Glass

Kod Code	ml ml	Model Model
46013250	250	Prizma / Prizma
46010060	60	Shot / Shot

Rakı Bardağı
Juice Glass



Viski Bardağı
Whiskey Glass



» Rakı/Viski Bardağı

Juice/Whiskey Glass

Kod Code	Model Model	ml ml	Ad./Koli Pcs/Ctn
46010240	Rakı/Juice	240	50
46012250	Viski/Whiskey	250	50

Kokteyl Bardağı
Cocktail Glass



Ayaklı Bardağı
Goblet Glass



» Ayaklı/Kokteyl Bardak

Goblet/Cocktail Glass

Kod Code	Model Model	ml ml	Ad./Koli Pcs/Ctn
46010295	Ayaklı/Goblet	295	50
46010320	Viski/Cocktail	320	50

Şarap Bardağı
Wine Glass



Goblet Bardağı
Goblet Glass



» Şarap Kadehi/Goblet Bardak

Wine/Goblet Glass

Kod Code	Model Model	ml ml	Ad./Koli Pcs/Ctn
46014250	Kadeh/Wine	250	50
46013400	Goblet/Goblet	400	50

Ayran-Bira Bardağı
Beer Glass



Tulip Glass



» Ayran-Bira/Tulip Bardak

Beer/Tulip Glass

Kod Code	Model Model	ml ml	Ad./Koli Pcs/Ctn
46010500	Ayran-Bira/Beer	500	24
46012400	Tulip/Tulip	400	100

460 461



» Çay-Kahve Kupası

Mug

Kod Code	ml ml	Ad./Koli Pcs/Ctn
46015250	250	50
46015300	300	50

460 461 462 463



» Kahve Kupası

Mug

Kod Code	ml ml
46010280	280

* Adet sağlanırsa tüm bardaklara logo ve yayı baskısı yapılabilir.

* Logo printing is possible for certain MOQ

* Tüm bardaklar koli bazında satılır.



Bar

Buz Kovaları & Şiše Soğutucular / Ice Buckets & Bottle Coolers



» Buz Kovası/Mini Punch Kasesi
D/W Ice Bucket/Mini Punch Bowl

Kod Code	Ø (cm) Ø (cm)
60030020	20

* Çift cidarlıdır.
* Double Wall



» Buz Kovası (Çift Cidarlı)
Ice Bucket (D/W)

Kod Code	Ölçü (cm) Dim. (cm)
60016118	Ø15,5x16,5



» Buz Kovası Büyük (Çift Cidarlı)
Big Ice Bucket (D/W)

Kod Code	Ölçü (cm) Dim. (cm)
60016119	Ø17x20,5



226 » Buz Kovası Halka Saplı Termoslu
Round Handled Ice Bucket

Kod Code	Model Model	Ø (cm) Ø (cm)
91000011	Kapaklı/w/Lid	15,5
91000012	Kapaklı&Tabaklı/w/Lid-Plate	15,5



» Buz Kovası Ay Saplı Termoslu
Crescent Handled Ice Bucket

Kod Code	Model Model	Ø (cm) Ø (cm)
91000016	Kapaklı/w/Lid	15,4
91000015	Kapaklı&Tabaklı/w/Lid-Plate	15,4



» Buz Kovası Akrilik
Acrylic Ice Bucket

Kod Code	Ölçü (cm) Dim. (cm)
60010761	Ø16,5x15



» Mat Şiše Soğutucu
D/W Satin Bottle Cooler

Kod Code	Ölçü (mm) Dim. (mm)
60016106	Ø12x20

* Çift cidarlıdır.
* Double Wall



Şampanya & Şarap Kovaları / Champagne & Wine Buckets



» Halka Saplı Şampanya Kova
Champagne/Wine Bucket

Kod Code	Ölçü (cm) Dim. (cm)
36752221	Ø 21x22



» Şampanya/Şarap Kova (Mat)
Champagne/Wine Bucket (Satin)

Kod Code	Ölçü (cm) Dim. (cm)
60016105	19x21



» Akrilik Şampanya/Şarap Kovası
Acrylic Champagne/Wine Bucket

Kod Code	Ölçü (cm) Dim. (cm)
60010760	Ø 22x20

228



» Şarap Kovası Masa Standı (Çelik)
Wine Bucket Table Stand

Kod Code	Ölçü (cm) Dim. (cm)
60010244	50x19x16



» Şişe Standı
Bottle Stand

Kod Code	Ölçü (cm) Dim. (cm)
60016141	26x8x14

* Şarap kovası fiyata dahil değildir.
* w/o Bucket



» Şampanya Kova Standı
Champagne Bucket Stand

Kod Code	Ölçü (cm) Dim. (cm)
37752222	65



» Melamin Fıçı Punch Kasesi
Melamine Barrel Punch Bowl

Kod Code	Øxh (mm) Øxh (mm)	Kapasite (Lt) Capacity (Lt)
91000016	307x90	4,5
91000015	307x150	8

* Kovanın dış ölçüsü : 30x30x19,5 cm
* Outer Dim. : Ø 30x19,5 cm



» Punch Kasesi
Punch Bowl

Kod Code	Ölçü (cm) Dim. (cm)
60010530	Ø 42x21



» Punch Kasesi Lux
Lux Punch Bowl

Kod Code	Ø (cm) Ø (cm)
60030037	37,5



» Ölçü Kabı Cam
Mixing Glass

Kod Code
60020008



» Klasik Shaker
Cocktail Shaker

Kod Code	ml ml
60010350	300
60010500	500
60010750	750



» Boston Shaker S/S
Boston Shaker S/S

Kod Code	ml ml
60020007	300
	500
	750

* Ölçü kabı fiyata dahil değildir.
* w/o Mixing Glass



» Garson Çakısı
Waiter's Corkscrew

Kod Code
83010045



» Tirbuşon
Winged Corkscrew

Kod Code
83010046





» Kadeh Tatlandırıcı
Chalice Sweetener

Kod
Code
60020009



» Pepet/Peçetelik
Napkin/Pipette Holder

Kod
Code
60020012



» Bar Konteynır
PC Bar Container

Kod Code	Model Model
60020004	4 Bölme / 4 Compartment
60020005	5 Bölme / 5 Compartment
60020006	6 Bölme / 6 Compartment

230



» Buz Kırıcı
Ice Crusher

Kod
Code
62040002



» Mojito Tokmagı
Ice Crusher (Mojito)

Kod
Code
62010031



» Bar Kaşığı Dövme Uçlu Twist Saplı
Bar Spoon/Masher (Full Twist)

Kod Code	Ölçü (cm) Dim. (cm)
56036222	22



» Jigger
Jigger

Kod Code	Kapasite Capacity	Ölçü (cm) Dim. (cm)
60016120	2/4 cc	Ø 45x10



» Akıtıcı
Pourer S/S

Kod
Code
62010033



» Bar Süzgeci
Bar Strainer

Kod
Code
62016137



» Üçlü Çerezlik
Triple Nuts Display

Kod Code	Ölçü (cm) Dim. (cm)
39311000	6,5
39311001	8
39311002	9
40310013	10



» Bölmeli Sosluk/Çerezlik
Partitioned Nuts Bowl

Kod Code	Model Model	Ölçü (cm) Dim. (cm)
80010195	2 Bölmeli / 2 Partitioned	10x17,5x2,5
80010196	3 Bölmeli / 3 Partitioned	10x26x2,7
80010197	4 Bölmeli / 4 Partitioned	10x33x2,5



» 2 Bölmeli Dikdörtgen Çerezlik
2 Part. Rectangular Nuts Bowl

Kod Code	Ölçü (cm) Dim. (cm)
80010001	13x24x4



» 2 Bölmeli Yuvarlak Çerezlik
2 Partitioned Round Nuts Bowl

Kod Code	Ölçü (cm) Dim. (cm)
80010002	10x20x5,5



» 3 Bölmeli Oval Çerezlik
3 Partitioned Oval Nuts Bowl

Kod Code	Ölçü (cm) Dim. (cm)
80010003	16,5x24x4



» 3 Bölmeli Yuvarlak Çerezlik
3 Partitioned Round Nuts Bowl

Kod Code	Ölçü (cm) Dim. (cm)
80010004	25,5x25,5x3



» Fiber Kaydırmaz Yuvarlak Tepsi
Fiber Non-slip Round Tray

Kod Code	Ø (cm) Ø (cm)
68210035	35,5
68210040	40,6
68210045	45

» Maun Kaydırmaz Yuvarlak Tepsi
Wooden Non-slip Round Tray

Kod Code	Ø (cm) Ø (cm)
68110033	33
68110038	38
68110043	43

» Maun Yuvarlak Tepsi
Wooden Round Tray

Kod Code	Ø (cm) Ø (cm)
68010033	33
68010038	38
68010043	43

232



» Fiber Kaydırmaz Dikdörtgen Tepsi
Fiber Non-slip Rectangular Tray

Kod Code	Ölçü (cm) Dim. (cm)
68213040	30x40
68213753	37x53
68214565	45x65
68215668	56x68

» Maun Kaydırmaz Dikdörtgen Tepsi
Wooden Non-slip Rectangular Tray

Kod Code	Ölçü (cm) Dim. (cm)
68112738	27x38
68113244	32x44
68113646	36x46
68113753	37x53
68114361	43x61

» Ecoform Kaydırmaz Tepsi
Ecoform Non-slip Rectangular Tray

Kod Code	Ölçü (cm) Dim. (cm)
68413753	37x53



» Kırçılı Tepsi
Textured Tray

Kod Code	Ölçü (cm) Dim. (cm)
46612736	27x36
46613244	32x44
46613646	36x46
46613753	37x53

» Maun Dikdörtgen Tepsi
Wooden Rectangular Tray

Kod Code	Ölçü (cm) Dim. (cm)
68012738	27x38
68013244	32x44
68013646	36x46
68013753	37x53
68014361	43x61

» Ecoform Tepsi
Ecoform Rectangular Tray

Kod Code	Ölçü (cm) Dim. (cm)
68313753	37x53



» Yuvarlak Havuzlu
Round Ashtray w/Cover

Kod
Code
35940000



» Kare Havuzlu
Square Ashtray w/Cover

Kod
Code
35930000



» Havuzlu Rüzgarlıkl
Wind Protected Ashtray

Kod Code	Model Model
43040011	Küçük / Small
43040010	Büyük / Big



» Döküm
Casted Black Ashtray

Kod Code	Model Model	Ölçü (cm) Dim. (cm)
43040004	Kare/ Square	8x8x3,5
43040005	Yuvarlak / Round	Ø 9,3x4



» Döküm
Casted Ashtray

Kod Code	Model Model	Ölçü (cm) Dim. (cm)
40350013	Kare/ Square	8x8x3,5
43040001	Yuvarlak / Round	Ø 9,3x4



» Döküm Bronz
Casted Bronze Ashtray

Kod Code	Model Model	Ölçü (cm) Dim. (cm)
43040002	Kare/ Square	8x8x3,5
43040003	Yuvarlak / Round	Ø 9,3x4

233



» Ayaklı Küllük Stand
Ashtray Stand

Kod Code	h (cm) h (cm)
40010004	76



» Dış Mekan Küllüğü
Outdoor Ashtray

Kod Code	Ölçü (cm) Dim. (cm)
48060002	40x99





Ekipmanlar

Equipments



- Yüksek verimli patentli soğutma sistemli motor
- Sağlam ve hafif fiberglass ABS gövde
- Yüksek verimli motorlar
- 3 farklı hız kontrolü
- Matkap sistemli hız kontrolü
- Sabitlenebilir hız kontrolü
- Cihazın yanlışlıkla açılmasını önleyen güvenlik mekanizması
- Sürekli karıştırma için tetik sistemli mandal
- 3 farklı motor
- IPX3 su geçirmezlik koruması
- Pratik montaj mekanizması
- Daha uzun ömür ve doğru temizlik için tamamen ayrılabilir miler
- Efficient engine cooling system
- Sturdy, lightweight ABS frame Glass Filled
- Practical and ergonomic handle
- Powerful performance engines
- Fixed speed
- Variotronic: speed control with stabilizer
- Safety system against accidental ignition
- The Trigger switch
- Available in 3 different engines
- The machine is protected with IPX3
- Quick coupling system
- Totally removable rods for a thorough cleaning which extends their life

Soğutmalı Motor
Ventilated Motor

236

Kod Code	Model Model
63010042	El Tipi Blender / Blender
63010023	Şaft 35 cm / Shaft 35 cm
63010008	Şaft 45 cm / Shaft 45 cm
63010009	Çırpıcı / Whisk
63010024	Duvar Askısı / Wall Attachment

63010042

El Tipi Blender
Blender

63010008

63010023

63010009

Çırpıcı ve Saftlar
Whisk and Shaft

63010024

Duvar Askısı
Wall Attachment

Güç / Power

750 W

Güç Kaynağı / Power Source

230 V/50 Hz

Bıçak Deviri / Knives Revolutions

r.p.m. 2000 - 11:500

Çalışma Kapasitesi / Working Capacity

300 Lt

Net Ağırlık / Net Weight

3,9 Kg

Ölçüler / Dimensions

A	B	C
125 mm	190 mm	390 mm

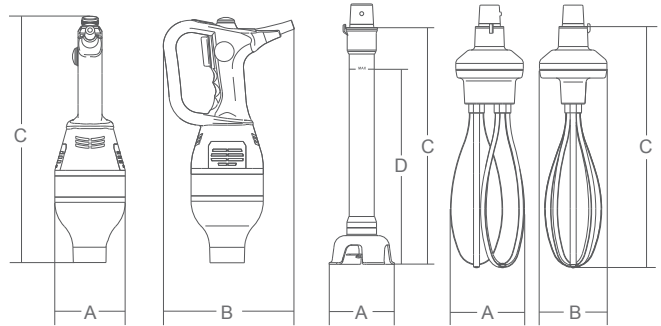

Made in Italy

- Yüksek verimli patentli soğutma sistemli motor
- Sağlam ve hafif fiberglas ABS gövde
- Yüksek verimli motorlar
- 3 farklı hız kontrolü
- Matkap sistemli hız kontrolü
- Sabitlenebilir hız kontrolü
- Cihazın yanlışlıkla açılmasını önleyen güvenlik mekanizması
- Sürekli karıştırma için tetik sistemli mandal
- 3 farklı motor
- IPX3 su geçirmezlik koruması
- Pratik montaj mekanizması
- Daha uzun ömür ve doğru temizlik için tamamen ayrılabilir miler
- Efficient engine cooling system
- Sturdy, lightweight ABS frame Glass Filled
- Practical and ergonomic handle
- Powerful performance engines
- Fixed speed
- Variotronic: speed control with stabilizer
- Safety system against accidental ignition
- The Trigger switch
- Available in 3 different engines
- The machine is protected with IPX3
- Quick coupling system
- Totally removable rods for a thorough cleaning which extends their life

 Soğutmalı Motor
Ventilated Motor

Kod Code	Model Model
63010006	El Tipi Blender / Blender
63010023	Şaft 35 cm / Shaft 35 cm
63010008	Şaft 45 cm / Shaft 45 cm
63010009	Çırpıcı / Whisk
63010024	Duvar Askısı / Wall Attachment

237



63010006



63010009



63010024

Güç / Power	550 W
Güç Kaynağı / Power Source	230 V/50 Hz
Bıçak Deviri / Knives Revolutions	r.p.m. 13.000
Çalışma Kapasitesi / Working Capacity	200 Lt
Net Ağırlık / Net Weight	3,5 Kg
Ölçüler / Dimensions	A B C 125 mm 190 mm 385 mm

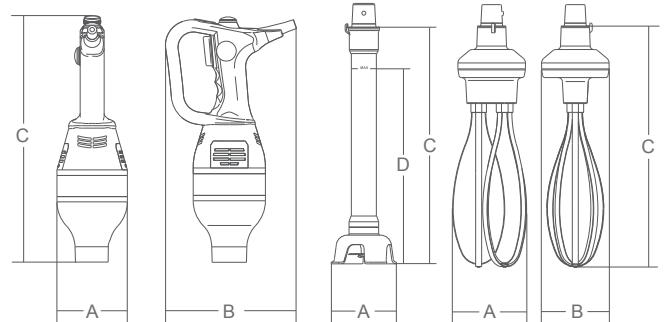



- Yüksek verimli patentli soğutma sistemli motor
 - Sağlam ve hafif fiberglass ABS gövde
 - Matkap sistemli hız kontrolü
 - Sabitlenebilir hız kontrolü
 - Cihazın yanlışlıkla açılmasını önleyen güvenlik mekanizması
 - Sürekli karıştırma için tetik sistemli mandal
 - IPX3 su geçirmezlik koruması
 - Pratik montaj mekanizması
 - Daha uzun ömür ve doğru temizlik için tamamen ayrılabilir miler
 - Paslanmaz çelik mil ve kampana
- Efficient engine cooling system
 - Sturdy, lightweight ABS frame Glass Filled
 - Fixed and variable speed controls available
 - Safety system against accidental ignition
 - The Trigger switch
 - The machine is protected with IPX3
 - Quick coupling system
 - Cutlery steel knives
 - Whisk with metal gearing
 - Whips Demountable and in the dishwasher

Sogutmalı Motor
Ventilated Motor



Kod Code	Model Model
63010006	El Tipi Blender / Blender
63010023	Şaft 35 cm / Shaft 35 cm
63010008	Şaft 45 cm / Shaft 45 cm
63010009	Çırpıcı / Whisk
63010024	Duvar Askısı / Wall Attachment

63010043



El Tipi Blender
Blender

63010045



Çırpıcı ve Saftlar
Whisk and Shaft

63010024



Duvar Askısı
Wall Attachment

Güç / Power	360 W
Güç Kaynağı / Power Source	230 V/50 Hz
Bıçak Deviri / Knives Revolutions	r.p.m. 12.000
Çalışma Kapasitesi / Working Capacity	70 Lt
Net Ağırlık / Net Weight	2,5 Kg
Ölçüler / Dimensions	A B C
	100 mm 182 mm 348 mm

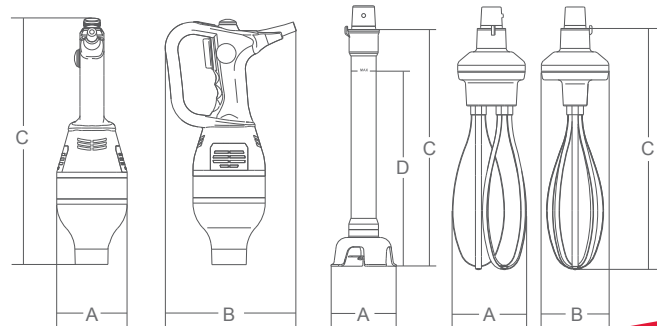

- Alüminyum alaşım ve paslanmaz çelik gövde
- Kesintisiz çalışma için soğutmalı motor
- Az yer kaplayan tasarımı sayesinde her mutfakta kolay kurulum
- Ayrıcalıklı besleme sistemi sayesinde yumuşak ürünleri işleme kolaylığı
- Besleme kolu, kapak ve toplama kabı arasındaki bağlantılı kilit sistemi sayesinde güvenli kullanım
- Her amaca uygun çok sayıda bıçak çeşidi (isteğe bağlı)

- Aluminium alloy and S/S construction.
- Ventilated motor for continuous operation.
- Thanks to its compact design the machine is easy to install inside every kitchen.
- The exclusive feeding system makes easy to process also soft products like moz-zarella cheese.
- Safe operation is ensured by interlock switches on product pusher, lid and collect-ing tray.
- Version with dishwashing safe S/S lid available
- Large number of discs available for every purpose



240



Disk Tutucu
Disc Holder

» Kod
Code

63010001

63010002

Model
Model

Sebze Doğrayıcı
Vegetable Cutter

Disk Tutucu
Disc Holder



Güç / Power

515 W

Güç Kaynağı / Power Source

230-400 V

Disk Deviri / Disc Revolutions

r.p.m. 300

Net Ağırlık / Net Weight

17,5 Kg

Ölçüler / Dimensions

A	B	C	D	E	G	H
225 mm	195 mm	255 mm	280 mm	510 mm	510 mm	770 mm

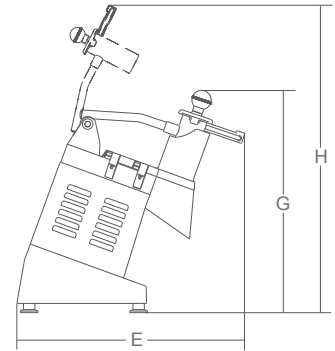
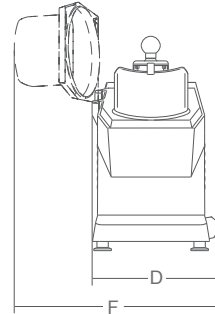
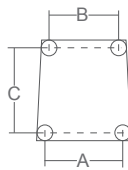



Dilimleyici Bıçaklar
Slicer Discs

* DF5 domates dilimleme için tavsiye edilir.

* DF5 is recommended for tomato slicing.

Kod Code	Kesme Kalınlığı (mm) Cutting Thickness (mm)
DF14	14
DF10	10
DF8	8
DF3	3
DF4	4
DF1	1
DF2	2
DF5*	5



Jülyen Dilimleyici Bıçaklar
Jullien Slicer Discs

Kod Code	Kesme Kalınlığı (mm) Cutting Thickness (mm)
DQ10	10
DQ8	8
DQ6	6
DQ4	4

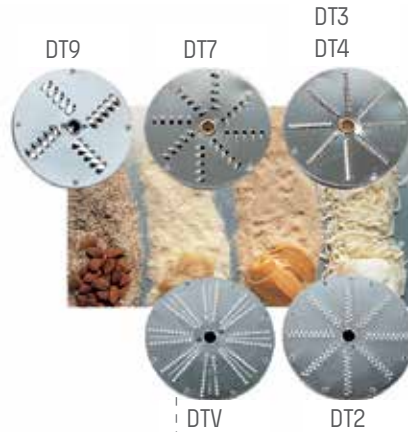

Rendeleyici ve Ufalayıcı Bıçaklar
Grater and Granulator Discs

Kod Code	Kesme Kalınlığı (mm) Cutting Thickness (mm)
DT9	9
DT7	7
DT4	4
DT3	3
DT2	2
DTV	1



Küp Doğrayıcı Bıçaklar
Dicer Discs

Kod Code	Kesme Kalınlığı (mm) Cutting Thickness (mm)
PS14	14
PS10	10
PS8	8

- Güçlü AISI 430 çelik gövde
- Daha iyi ısı yalıtımı için bağımsız motor ve kase
- Kalın tabanlı ve saplı paslanmaz kase
- Sürekli işleme uygun yüksek etkili soğutmalı motor
- Güçlü çelik bıçaklar
- Kapak üzerinde güvenli işletimi sağlayan mikro anahtarlar
- Şeffaf lexan kapak
- Sabitleyici hız kontrolü
- İşletim sırasında malzeme eklemeye uygun açılabilen kapak
- Kademesiz değişken hız sürücüsü
- Spatula ve bilek taşı dahildir
- Strong AISI 430 steel construction
- Detached motor and bowl for a better thermal insulation
- S/S bowl with handles and heavy bottom
- High efficiency ventilated motor for continuous operation
- Strong cutlery steel knives
- Safe operations ensured by a system of micro switches on the lid
- See-through lexan lid
- Variotronic: speed control with stabilizer
- Lid with opening to add ingredients during operation



Sogutmalı Motor
Ventilated Motor

» Kod
Code

Model
Model

63010004
63020004
63030004
63040004

Sebze Doğrayıcı / Vegetable Cutter
Emülsiyon Bıçağı / Emulsifying Knife
Dişli Bıçak / Serrated Knife
Pesto Bıçağı (4 bıçaklı) / Shaft w/knives for pesto sauce

* Standart bıçak fiyata dahildir.
* Incl/Standard blade



Standart bıçak
Standard knife

242

63020004



Emülsiyon Bıçağı
Emulsifying Knife

63030004



Dişli Bıçak
Serrated Knife

63040004



Pesto sosu için 4 bıçaklı shaft
Shaft w/knives for pesto sauce

Güç / Power

350 W

Hazne Kapasitesi / Bowl Capacity

3,3 Lt

Hazne Dolma Seviyesi / Bowl Filling Level

1,5 Lt

Devir / Revolutions

r.p.m. 2.800

Net Ağırlık / Net Weight

10 Kg

Ölçüler / Dimensions

A B C D E
160 mm 310 mm 305 mm 365 mm 255 mm

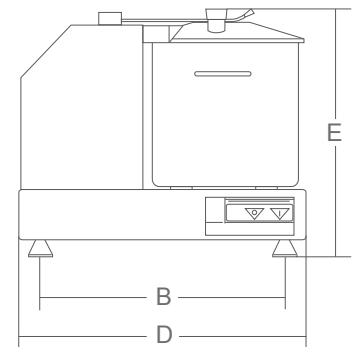
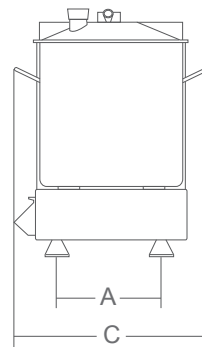

Made in Italy

- Güçlü AISI 430 çelik gövde
- Daha iyi ısı yalıtımı için bağımsız motor ve kase
- Kalın tabanlı ve saplı paslanmaz kase
- Sürekli işleme uygun yüksek etkili soğutmalı motor
- Güçlü çelik bıçaklar
- Kapak üzerinde güvenli işletimi sağlayan mikro anahtarlar
- Şeffaf lexan kapak
- Sabitleyici hız kontrolü
- İşletim sırasında malzeme eklemeye uygun açılabilen kapak
- Kademesiz değişken hız sürücü
- Spatula ve biley taşı dahildir
- Strong AISI 430 steel construction
- Detached motor and bowl for a better thermal insulation
- S/S bowl with handles and heavy bottom
- High efficiency ventilated motor for continuous operation
- Strong cutlery steel knives
- Safe operations ensured by a system of micro switches on the lid
- See-through lexan lid
- Variotronic: speed control with stabilizer
- Lid with opening to add ingredients during operation

 Soğutmalı Motor
Ventilated Motor

 >> Kod
Code

 63010005
63020005
63030005
63040005

 Model
Model

 Sebze Doğrayıcı / Vegetable Cutter
Emülsiyon Bıçağı / Emulsifying Knife
Dişli Bıçak / Serrated Knife
Pesto Bıçağı (4 bıçaklı) / Shaft w/knives for pesto sauce

 *Standart bıçak fiyata dahildir.
*Incl/Standard blade

 Standart bıçak
Standard knife

243

63020004

 Emülsiyon Bıçağı
Emulsifying Knife

63030004

 Dişli Bıçak
Serrated Knife

63040004

 Pesto sosu için 4 bıçaklı shaft
Shaft w/knives for pesto sauce

Güç / Power

350 W

Hazne Kapasitesi / Bowl Capacity

5,3 Lt

Hazne Dolma Seviyesi / Bowl Filling Level

3,1 Lt

Devir / Revolutions

r.p.m. 1.500+2.800

Net Ağırlık / Net Weight

11 Kg

Ölçüler / Dimensions

A	B	C	D	E
160 mm	310 mm	305 mm	365 mm	320 mm

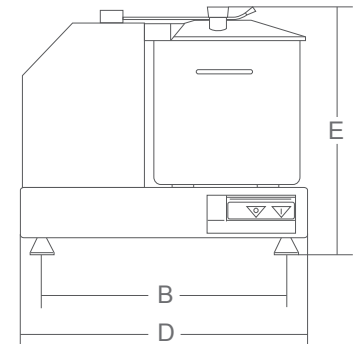
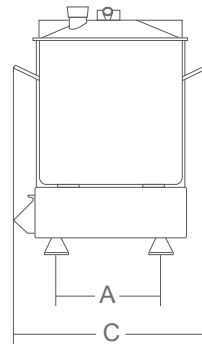

- Güçlü AISI 430 çelik gövde
- Daha iyi ısı yalıtımı için bağımsız motor ve kase
- Kalın tabanlı ve saplı paslanmaz kase
- Sürekli işleme uygun yüksek etkili soğutmalı motor
- Güçlü çelik bıçaklar
- Kapak üzerinde güvenli işletimi sağlayan mikro anahtarlar
- Şeffaf lexan kapak
- Sabitleyici hız kontrolü

- Base-plate and reservoir in heat-resistant ABS
- Lid in PC with hole to add the ingredients during processing
- Interlocked lid and reservoir, easy to disassemble though for cleaning
- Motor brake
- Control with NVR 24 Volt IP 67
- Included items:
- Hub with cutting knives in stainless steel
- Hub for ABS assembly
- Dismountable scraping blade



Sogutmalı Motor
Ventilated Motor

Kod Code	Model Model
63010003	Sebze Doğrayıcı / Vegetable Cutter
63030006	Temizleme Bıçağı / Board Scraper

* Bıçaklar fiyata dahildir.
* Knives included

244



Temizleme Bıçağı
Board Scraper



Hamur karıştırıcı bıçaklı shaft
Shaft w/knives to mix dough

Güç / Power	350 W
Hazne Kapasitesi / Bowl Capacity	3,3 Lt
Hazne Dolma Seviyesi / Bowl Filling Level	1,5 Lt
Devir / Revolutions	r.p.m. 2.800
Net Ağırlık / Net Weight	10 Kg
Ölçüler / Dimensions	A B C D E
	160 mm 310 mm 305 mm 365 mm 255 mm

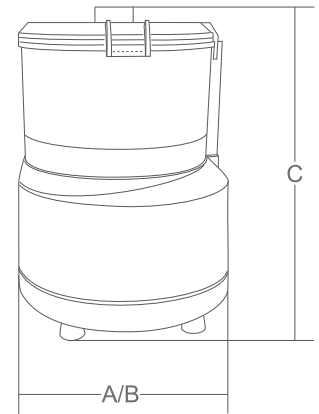

- Yüksek performans ve çalışma kapasiteli, tek parça dayanıklı cihaz
- Peyniri ve ekmeği aynı oranda ve ziyan etmeden rendeleme olanağı
- Cilalanmış alüminyum gövde, işlenmiş paslanmaz çelik silindir
- Strong machine, simple and compact, gives a high performance and power.
- It offers thr possibility of grating cheese and bread with uniformity and without any waste.
- Structure realised in polished aluminium, treated steel roller anti-corrosive.



» Kod
Code

63010021

Model
Model

Peynir rendeleyici / Cheese Grater

245



Muhafazalı Rende / Paslanmaz çelik silindir
Protection grater / Stainless steel drum



Rende üzerinde mikro anahtar
Microswitch on the grater

Güç / Power

588 W

Güç Kaynağı / Power Source

230 - 400 V/50-60 Hz F+N

Silindir Devri / Drum Revolutions

r.p.m. 1400

Giriş Ebatı / Mouth Revolutions

130 x 70

Net Ağırlık / Net Weight

16 Kg

Ölçüler / Dimensions

A B C D E F
185 mm 270 mm 290 mm 390 mm 370 mm 560 mm

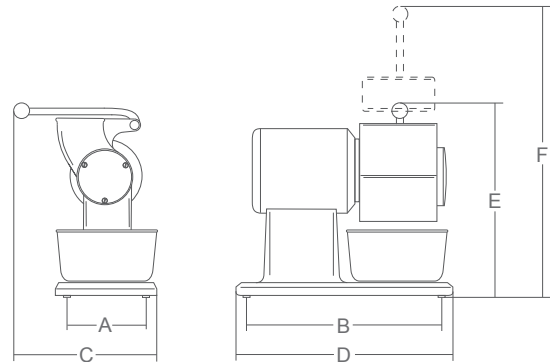

- Boyalı alüminyum gövde
- Döküm alüminyum parçalar
- Kolay temizlemeye uygun bıçak-motor aralığı
- Soğutmalı motor
- Hassas kalınlık ayarı desteği
- Kendi üzerine monteli bileyici düzenegi
- Küçük boyutlar ve yüksek kesme kapasitesi
- 25° bıçak eğim
- Anodized cast aluminium alloy
- Great distance between blade and motor for easy cleaning
- Ventilated motor
- Forged, hardened large thickness blades
- Strong thickness gauge support
- Cast-in sharpener assembly
- Compact dimensions and great cutting capacity
- CE professional with device for releasing the carriage
- 25° blade inclination



250

Soğutmalı Motor
Ventilated Motor

246

» Kod
Code

63010250

Model
Model

Dilimleyici 250 / Slicer 250



Bıçak / Blade

Ø 250 mm

Motor / Motor

147 W / 0,20 Hp

Kesme Kalınlığı / Cut Thickness

13 mm

Hareket Mesafesi / Run of Carriage

245 mm

Hazne / Hopper

230 x 230 mm

Kesim Kapasitesi / Cut Capacity

215 x 180

Ölçüler / Dimensions

A	B	C	D	E	F	G	L
395 mm	245 mm	500 mm	560 mm	370 mm	570 mm	475 mm	490 mm

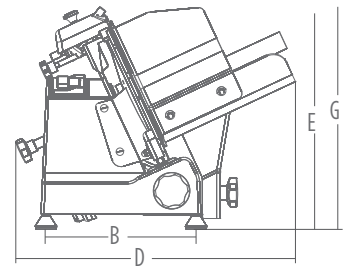
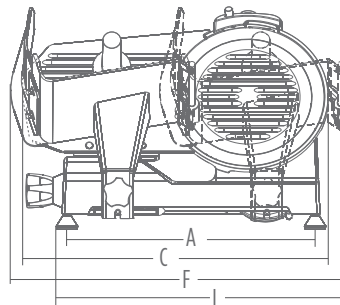

- Elokssallı alüminyum alaşım gövde
- Kolay temizlemeye uygun bıçak-motor aralığı
- Soğutmalı motor
- Güçlendirilmiş ve sertleştirilmiş kalınlık ayar bıçakları
- Kendinden yağlamalı mil yatağı
- Hassas kalınlık ayarlama kolu
- Yüksek kesim kapasitesi
- 25° bıçak eğimi
- Anodized cast aluminium alloy
- Great distance between blade and motor for easy cleaning
- Ventilated motor
- Forged, hardened large thickness blades
- Strong thickness gauge support
- Cast-in sharpener assembly
- Compact dimensions and great cutting capacity
- CE professional with device for releasing the carriage
- 25° blade inclination

**250**Soğutmalı Motor
Ventilated Motor» Kod
Code

63010026

Model
Model

Dilimleyici 250 / Slicer 250

247



Bıçak / Blade

Ø 250 mm

Motor / Motor

147 W / 0,20 Hp

Kesme Kalınlığı / Cut Thickness

13 mm

Hareket Mesafesi / Run of Carriage

245 mm

Hazne / Hopper

230 x 230 mm

Kesim Kapasitesi / Cut Capacity

215 x 180

Ölçüler / Dimensions

A	B	C	D	E	F	G
395 mm	245 mm	500 mm	560 mm	370 mm	570 mm	475 mm

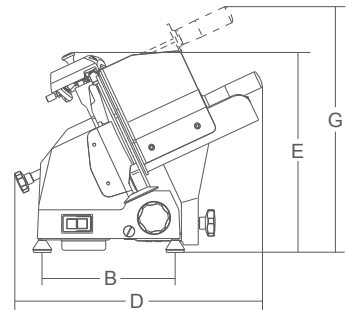
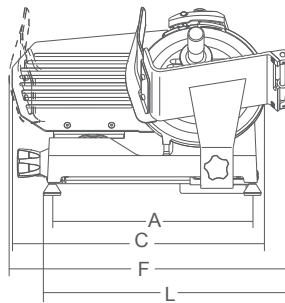

- Elokısalı döküm alüminyum gövde
 - Kolay temizlemeye uygun bıçak - motor aralığı
 - Soğutmalı motor
 - Güçlendirilmiş, kalın dövme bıçaklar
 - Kendinden yağlamalı mil yatağı ve üst üste bindirilmiş pim üzerinde çalışan hareketli parça
 - Hassas kalınlık ayarı desteği
 - Küçük boyutlar ve yüksek kesme kapasitesi
 - 25° bıçak eğimi
- Anodized cast aluminium alloy
 - Great distance between blade and motor for easy cleaning
 - Ventilated motor
 - Forged, hardened large thickness blades
 - Strong thickness gauge support
 - Cast-in sharpener assembly
 - Compact dimensions and great cutting capacity
 - CE professional with device for releasing the carriage
 - 25° blade inclination



300

Soğutmalı Motor
Ventilated Motor

248

» Kod
Code

63010300

Model
Model

Dilimleyici 300 / Slicer 300

Hareketli parçayı ayıran mekanizma
Device for releasing the carriageKolay temizlemeye uygun bıçak - motor aralığı
More space between blade and body machineKapalı ve sızdırmaz kayış kasağı
Enclosed and sealed belt pulley standard

Bıçak / Blade

Ø 300 mm

Motor / Motor

210 W

Kesme Kalınlığı / Cut Thickness

13 mm

Hareket Mesafesi / Run of Carriage

285 mm

Hazne / Hopper

250x275 mm

Kesim Kapasitesi / Cut Capacity

20,5 Kg

Ölçüler / Dimensions

A	B	C	D	E	F	G	L
435 mm	295 mm	600 mm	610 mm	420 mm	640 mm	510 mm	535 mm

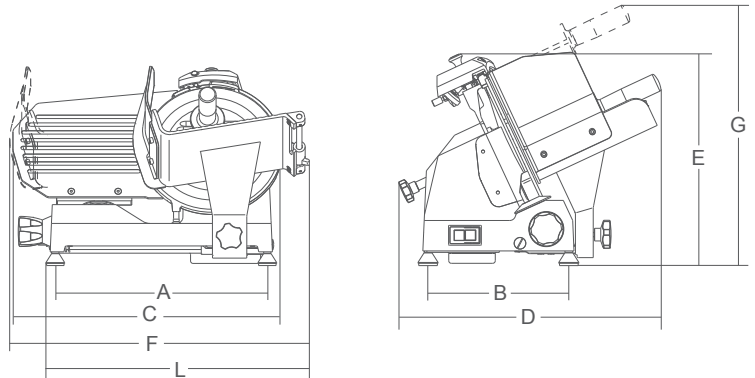

- Köşesiz, yuvarlak dizayn
- Hareketli parça üzerinde sertleştirilmiş kauçuk durdurucular
- Kapalı ve sızdırmaz kayış kasnağı
- Motor ve bıçak arasında 49,5 mm mesafe
- Taban kapağı
- 110- 220- 380 V değiştirilebilir tek ve üç aşamalı elektronik devir
- Taban korumalı gömme bileyici
- Bıçak çıkartma aparatı
- 35° bıçak eğimi
- IP67 koruma seviyeli plastik basma düğmeleri
- Rounded design, no sharp edges and visible screws
- Vulcanized rubber stops on carriage
- Removable support cover for thickness gauge plate
- Enclosed and sealed belt pulley
- 49,5 mm distance between blade and motor
- Bottom cover
- Changeover electronic circuit 110-220-380 V single and three phase
- Built in sharpening tool with bottom protection
- Standard blade removal tool
- 35° blade inclination
- Plastic pushbuttons with IP67 protection rating



Soğutmalı Motor
Ventilated Motor

350

249

» Kod
Code

63010350

Model
Model

Dilimleyici 350 / Slicer 350



Bıçak ve gövde arasında daha fazla mesafe
More space between blade and body machine



Geniş Hazne
Large hopper

Bıçak / Blade

Ø 350 mm

Motor / Motor

370 W

Kesme Kalınlığı / Cut Thickness

23 mm

Hareket Mesafesi / Run of Carriage

310 mm

Hazne / Hopper

305x270 mm

Kesim Kapasitesi / Cut Capacity

46 Kg

Ölçüler / Dimensions

A B C D E F G L
465 mm 340 mm 660 mm 575 mm 455 mm 710 mm 530 mm 590 mm

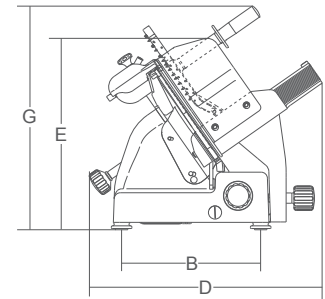
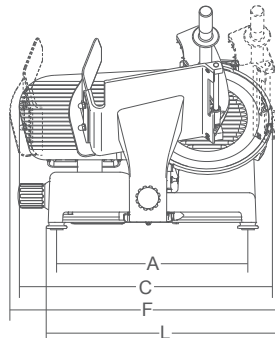



- Köşesiz, yuvarlak dizayn
- Motor ve bıçak arasında 48 mm mesafe
- Krom kaplamalı, kayar mil
- Hareketli parça üzerinde sertleştirilmiş kauçuk durdurucular
- Kalınlık ayar bıçağı üzerinde çıkarılabilir koruma kapağı
- Elektrik aksamına erişimi engelleyen alt kapak
- Taban korumalı dahili bileyici
- Bıçak çıkartma aparatı
- IP67 koruma seviyeli plastik düğmeler
- Rounded design and no sharp edges or visible screws
- Chrome plated ground and lapped slide rod
- Vulcanised rubber stops on carriage
- Removable support cover for thickness gauge plate
- Bottom cover for accessing electrical Components
- Built-in sharpening tool with bottom protection
- Easy to remove grease guard mounted along the thickness gauge plate
- Standard blade removal tool
- Plastic pushbuttons with IP67 protection rating



Dik Tip Vertical

Soğutmalı Motor
Ventilated Motor

» Kod
Code
63010027

Model
Model
Dik Tip Dilimleyici / Vertical Slicer

251



Bıçak / Blade

Motor / Motor

Kesme Kalınlığı / Cut Thickness

Hareket Mesafesi / Run of Carriage

Hazne / Hopper

Kesim Kapasitesi / Cut Capacity

Ölçüler / Dimensions

Ø 350 mm

370 W / 0,50 Hp

29 mm

310 mm

300 x 270 mm

215 x 180

A B C D E F G L
468 mm 338 mm 660 mm 600 mm 530 mm 750 mm 715 mm 630 mm

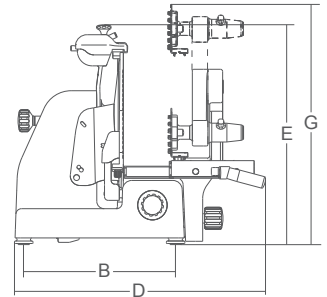
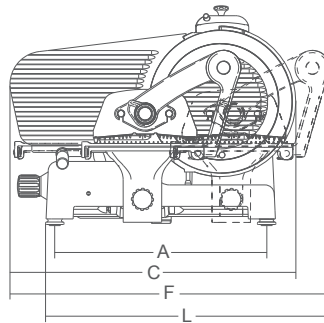

- Metal Döküm planet mikser
- Kaldırılabilir üst parça sayesinde çıkabilir hazne ve ekipmanlar, kolay temizlik
- Çıkarılabilir 7 lt paslanmaz çelik kase
- 3 adet metal aparat
- Hız kontrollü D.C. motor
- Üst gövde de güvenlik kilidi
- NVR cihazı
- Orta yoğunluklu karışım için uygundur
- Yüksek yoğunluklu karışım için uygun değildir
- Metal cast planetary mixer
- Lifiable head for bowl and tools removal and easy cleaning
- Removable, S/S, 7L bowl
- 3 metal tools
- D.C. motor with speed control
- Safety microswitch on the head
- NVR device
- Suitable for medium density mix (for ex. Bread dough, about 1 kg of flour)
- NOT suitable for tough mix



7 Lt

252



Güç / Power

280 W

Güç Kaynağı / Power Source

230 V/50 Hz

Çırpma Devri / Whisk Revolutions

g./75+660

Hazne Kapasitesi / Bowl Capacity

7 Lt

Net Ağırlık / Net Weight

18 Kg

Ölçüler / Dimensions

A	B	C	D
240 mm	410 mm	425 mm	540 mm

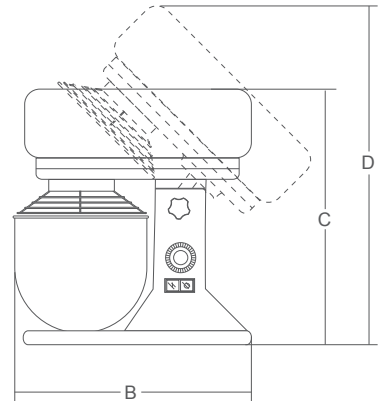
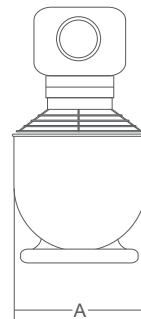

- Yüksek kalınlıkta toz boya kaplı çelik gövde
- Metal ızgara korumalı hazne
- Kolay çıkarılabilir 304 paslanmaz çelik hazne
- Hazne ve kapak için güvenlik kilidi
- Çıkarılabilir 3 metal parça: alüminyum spatula, kanca, çelik ve alüminyum çırpıcı
- 3 hız kademesi
- Çelik şanzıman kutusu
- Soğutmalı motor

- Machine body made from large thickness powder coated steel
- Bowl protection made from metal wire
- Easy to remove bowl made from stainless steel 304
- Safety microswitches for the lid and the bowl
- 3 easy to remove metal tools: aluminium spatula and hook, steel and aluminium whisk
- 3 speed gear
- Steel gear box
- Ventilated motor

10 Lt

**Minneapolis**

253

» Kod
Code

63010010

Model
Model

Planet Mikser 10 Lt / Planet Mixer 10 Lt

Güç / Power

450 W

Güç Kaynağı / Power Source

230 V/50 Hz

Çırpma Devri / Whisk Revolutions

108/195/355 r.p.m.

Hazne Kapasitesi / Bowl Capacity

10 Lt

Net Ağırlık / Net Weight

74 Kg

Ölçüler / Dimensions

A	B	C	D	E
360 mm	345 mm	440 mm	500 mm	630 mm

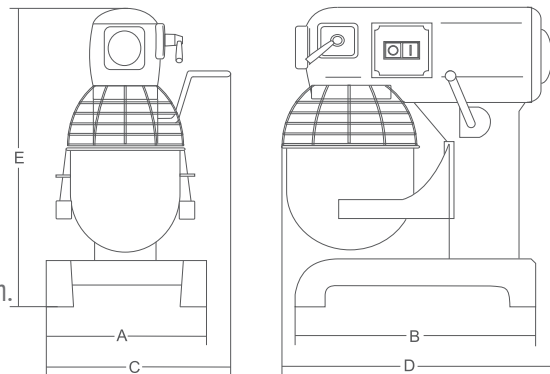

- Tezgah üstü model; Hijyenik ve paslanmaz polisajlı eloksallı alüminyum gövde
- Paslanmaz çelik kesim tablası, et itici ve et dilimleyici
- Kemik veya et kesmeye uygun 16 mm, geniş, güçlendirilmiş bıçaklar (donmuş ve taze)
- Kapı üzeri ve motor fren mikroswitchi (yeni CE güvenlik kurallarına göre)
- 24V emniyetli kontrol
- Makaraların yarı bükülmüş şekli sayesinde mükemmel bıçak-makara tutuşu
- Yağ keçesi ile korunan 4 kutuplu eşzamansız ve soğutmalı motor
- Güvenli ve kolay kullanım
- Table-top model; cast anodizedaluminium alloy construction, polished, hygienic and rustproof
- Cutting table, meat pusher and meat pusher in stainless steel AISI 304
- 24V controls with safety codified microswitches on the door and motor brake (according to new CE safety rules)
- Powerful asynchronous and ventilated 4-pole motors protected by sealing oil ring
- 16 mm wide tempered ring-blades useful for cutting bones or meat (frozen or fresh)
- Simple and sturdy machine: safe and easy to use



254



» Kod
Code

63010048

Model
Model

Et-Kemik Testeresi / Bone Saw

Bıçak Uzunluğu / Blade Length

1840 mm

Motor / Motor

1100 W / Hp 1,5

Makarna Pulley

250 mm

Net Ağırlık / Net Weight

40 Kg

Ölçüler / Dimensions

A	B	C	D	E	F	G
530 mm	600 mm	640 mm	950 mm	915 mm	250 mm	240 mm

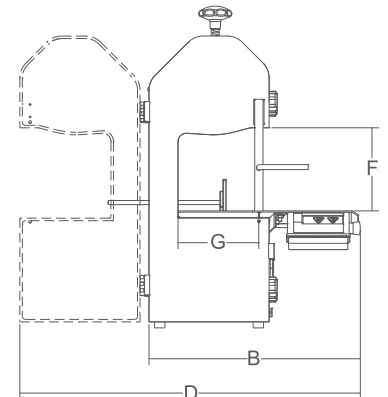
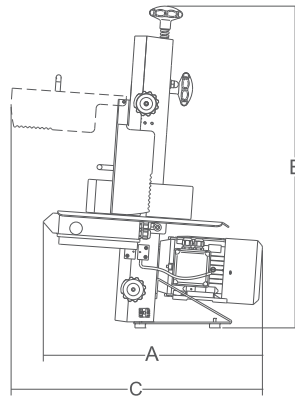

- Tezgah üstü model; Hijyenik ve paslanmaz polisajlı eloksallı alüminyum gövde
- Paslanmaz çelik kesim tablası, et itici ve et dilimleyici
- Kemik veya et kesmeye uygun 16 mm, geniş, güçlendirilmiş bıçaklar (donmuş ve taze)
- Kapı üzeri ve motor fren mikroswitchi (yeni CE güvenlik kurallarına göre)
- 24V emniyetli kontrol
- Makaraların yarı bükülmüş şekli sayesinde mükemmel bıçak-makara tutuşu
- Yağ keçesi ile korunan 4 kutuplu eşzamansız ve soğutmalı motor
- Güvenli ve kolay kullanım
- Table-top model; cast anodized aluminium alloy construction, polished, hygienic and rustproof
- Cutting table, meat pusher and meat pusher in stainless steel AISI 304
- 24V controls with safety codified microswitches on the door and motor brake (according to new CE safety rules)
- Powerful asynchronous and ventilated 4-pole motors protected by sealing oil ring
- 16 mm wide tempered ring-blades useful for cutting bones or meat (frozen or fresh)
- Simple and sturdy machine: safe and easy to use

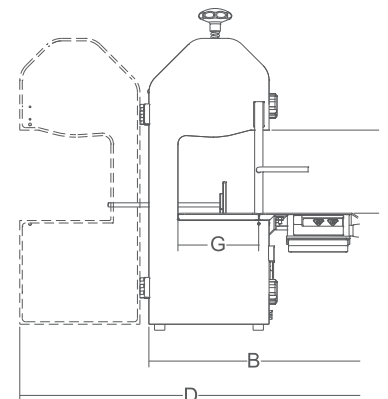
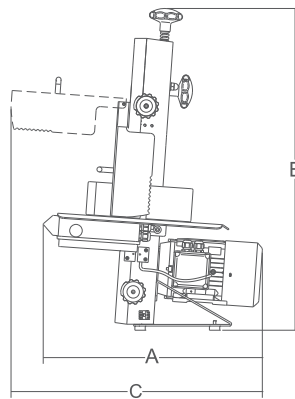

Bıçak Uzunluğu / Blade Length

1550 mm

Motor / Motor

1 ph-Hp 1/r.p.m. 1400
3 ph-Hp 1,5/r.p.m. 1400

Makarna Pulley

210 mm

Net Ağırlık / Net Weight

32 Kg

Ölçüler / Dimensions

A	B	C	D	E	F	G
530 mm	510 mm	606 mm	822 mm	778 mm	215 mm	195 mm

- Düşük hacimli ürünler için kompakt ve hızlı paketlenme
- Vakum ve yapıştırma zaman ayarı
- Gösterge Paneli: Vakum yüzdesi ve kalan zaman göstergesi
- Yağ değiştirme uyarısı
- Zaman ayarlı dış vakum
- DVP vakum pompası
- Softcooker cihazı ile ideal kombinasyon
- A compact and fast machine for small sized product
- Easily settable vacuum and sealing time
- Bush suction pump
- Display of vacuum percentage and time to countdown
- Rev counter and pump meter
- Pump preheating and oil cleaning cycle
- Change oil message
- Timed external vacuum



Güç / Power	0,1 kw
Güç Kaynağı / Power Source	230 V/50 Hz
Vakum Pompası / Vacuum Pump	mc/h 4
Net Ağırlık / Net Weight	30 Kg
Ölçüler / Dimensions	320x560x257 mm

256



» Kod Code	Model Model
63010030	Vakumlu Paket Makinesi Vacuum Packaging Machines

- Vakum ve yapıştırma zaman ayarı
- Gösterge Paneli: Vakum yüzdesi ve kalan zaman göstergesi
- Son kullanılan ayarın hafızaya kaydedilebilme özelliği
- Her vakum döngüsünden sonra otomatik açılan kapak
- Yağ değiştirme uyarısı
- Zaman ayarlı dış vakum
- Ön ısıtma pompası ve yağ temizleme döngüsü

- Easy vacuum and sealing time setting
- Display of vacuum percentage and time to countdown
- Last setting saved in memory
- Rev counter and pump meter
- Pump preheating and oil cleaning cycle
- Oil change message
- Timed external vacuum
- Automatic cover lift operated by pneumatic pistons

Güç / Power	0,45 Kw
Güç Kaynağı / Power Source	230 V/50 Hz
Vakum Pompası / Vacuum Pump	mc/h 12
Net Ağırlık / Net Weight	54 Kg
Ölçüler / Dimensions	493x585x370 mm



» Kod Code	Model Model
63010035	Vakumlu Paket Makinesi Vacuum Packaging Machines



- Düşük ısıda vakumlu gıda pişirme cihazı
- Hafızaya alınabilir 5 ayrı program
- 50 - 80 lt kullanım kapasitesi
- Isı göstergeli
- Sıvısız yanlış kullanım durumunda cihazı otomatik kapatan koruma sistemi
- Aşırı yüklemeye ve aşırı ısınmayı engelleyen ısı sensörü
- Kullanılan gıda konteynırına sabitleme kelepçesi (maks. Derinlik 16,5 cm)
- Kolay taşıma sağlayan paslanmaz çelik sap

- High precision warmer with temperature control
- Working temperature display
- 5 storable programs
- IP X3 protection rated stainless steel structure
- Can be applied to the pot by means of a clamp. (max depth 16,5 mc)
- Best performances up to 50/80 lt
- Protection device switches off the warmer in case of accidental use outside the liquid
- Circulating pump to help the best product mixing
- Temperature sensor to prevent overload and overheating
- A convenient stainless steel handle makes it easy to carry



258

» Kod
Code

63010051

Model
Model

Soft Cooker

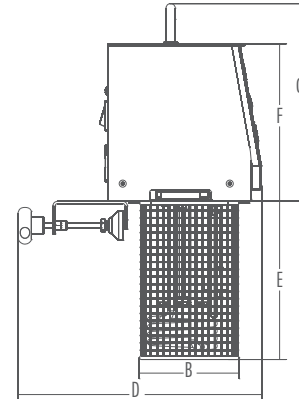
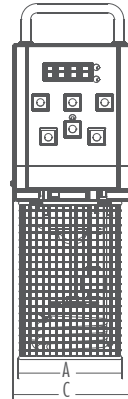

Güç / Power

2000 Watt

Güç Kaynağı / Power Source

230 V/50 Hz

Isı / Temperature

°C 40 / 115

Net Ağırlık / Net Weight

4,5 Kg

Ölçüler / Dimensions

A	B	C	D	E	E	G
110 mm	105 mm	130 mm	260 mm	170 mm	170 mm	210 mm

- Paslanmaz Çelik gövde ve GN 1/1 küvet
 - Hafızaya alınabilir 5 ayrı program
 - Isı göstergeli elektronik ısı kontrolü
 - Alt tankla bağlantılı darbe dayanıklı ısıtma parçaları
 - C° and F°de ısı ayar seçenekleri
 - Kolay taşıma için pratik saplar
- Stainless steel structure and 1/1 GN made of stainless steel
 - Practical handles to carry it easily
 - Powerful shock-proof coated heating elements in contact with tank bottom
 - Electronic control system of the temperature with working temperature display
 - Same control system of Softcooker with delta T of 0,2°C
 - 5 storable programs
 - Temperature setting in C° and F°
 - Equipped with lid



» Kod
Code
63010049

Model
Model
Softcooker GN 1/1

259



Güç / Power
Güç Kaynağı / Power Source
Isı / Temperature
Net Ağırlık / Net Weight
Ölçüler / Dimensions

1150 Watt
230 V/50 Hz
°C 40 / 115
5 Kg
X Y H
110 mm 105 mm 130 mm

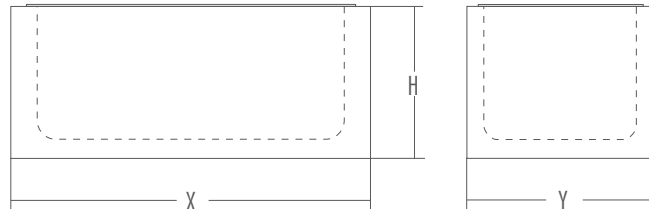

- Paslanmaz çelik gövde
- 2 ızgara ve mikrodalga seçeneği
- Kırılmaz camdan mamül döner tabak
- 30 dak. zaman ayarı
- 25 lt iç hacim
- Mikrodalga: 6 farklı güç seviyesi
- Ağırlık bazlı otomatik buz çözme
- Restaurant ve barlar için ideal
- 340x330xH.220 mm iç hacim
- 900 W çıkış gücü
- Stainless steel construction
- Tempered glass rotating plate
- Timer 30 min.
- Microwave: 6 different power levels
- 2 grill-microwave combination
- Weight-based automatic defrost
- Ideal for small restaurants and bars



Güç / Power

1400 W m.o./1000 W grill

Güç Kaynağı / Power Source

230 V/50 Hz

Güç Kademesi / Power Level

n. 5

» Kod
Code

63010055

Model
ModelMikrodalga Fırın
Microwave Oven

Mikrodalga Frekansı / Microwave Frequency

MHz 2450

260

Hazne kapasitesi / Inside Volume

25 Lt

Net Weight / Net Ağırlık

14,5 Kg

Ölçüler / Dimensions

483x422x281 mm

- Paslanmaz çelik kabin
- Cam seramik pişirme tepsi
- 5 ayrı güç seviyesi ile çok yönlü kullanım
- Zaman ve ısı ayarları için manuel kontrol
- 25 lt kapasite
- Restaurant ve barlar için ideal
- 330x360xH.200 mm iç hacim
- High versatility with 5 power levels
- Manual controls for power and timer
- Stainless steel cabinet and cavity finish
- Ceramic glass cooking plate
- See-through opening door with practical handle
- 25 lt inside volume
- Inner dimensions 330x360x200 mm

» Kod
Code

63010054

Model
ModelMikrodalga Fırın
Microwave Oven

Güç / Power

1500 W

Güç Kaynağı / Power Source

230 V/50 Hz

Güç Kademesi / Power Level

n. 6

Mikrodalga Frekansı / Microwave Frequency

MHz 2450

Hazne kapasitesi / Inside Volume

25 Lt

Net Weight / Net Ağırlık

17,7 Kg

Ölçüler / Dimensions

520x442x312 mm

- Paslanmaz çelik gövde ve iç duvarlar
- Raf arası yükseklik 8 cm
- Pürüzsüz yuvarlak kenarlar kolay temizlenebilir
- Çift camlı paslanmaz çelik kapak
- Çift lambalı aydınlatma
- 25 °C'den 300 °C'ye kadar termostatlı ısı kontrolü
- 0'dan 100'e programlanabilir zamanlayıcı
- Restaurant ve barlar için ideal
- 480x360x300 mm iç hacim
- Stainless steel construction including chamber
- Distance between shelves cm 8
- Seamless, round-cornered and easy to clean chamber to prevent contamination
- Double glass stainless steel door
- Effective 2 lamp chamber lighting
- Thermostatically controlled temperature from 25°C to 300°C (77°F to 572°F)
- Choice of 0' to 120' programmable timer or continuous operation
- Ideal for Restaurants
- Inner dimensions 480x360x300 mm



» Kod
Code
63010060

Model
Model
Konveksiyon Fırın
Convection Oven

261



Güç / Power	2600 W
Güç Kaynağı / Power Source	230 V/50 Hz
Isı Derecesi / Temperature	25 / 300°C
Raf Sayısı / Number of Shelves	4
Tepsi Ölçüsü / Tray Dimensions	440x330 mm
İç Kapasite / Inner Dimensions	480x360x300 mm
Net Ağırlık / Net Weight	35 Kg
Ölçüler / Dimensions	750x1000x850 mm

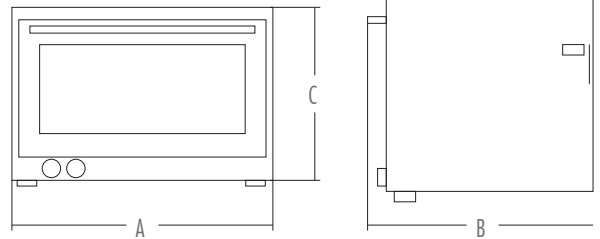



- AISI 304 Paslanmaz Çelik
- Farklı hız ayarları
- Fan soğutmalı kontrol bölümü
- Yükleme, boşaltma kızakları
- Termal yalıtımlı hazne
- Kendinden soğutmalı motor
- Bağımsız değiştirilebilen Kuartz kaplı ısıtma parçaları
- Kolay çıkarılabilen kırıntı tavası
- Made from AISI 316 S/S with AISI 304 S/S conveyor belt
- Thermal insulation of the chamber
- SEF-ventilated motor
- Fan cooled controls compartment
- The heating elements covered by quartz tubes can be switched on independently
- Variable speed drive (VV versions)
- Loading and unloading chutes
- Easy to remove crumb pan

» Kod	Model
Code	Model
63010037	Konveyörlü Ekmek Kızartma Makinesi Conveyor Toaster

Güç / Power	2660 W
Güç Kaynağı / Power Source	230 V/50-60 Hz F+N
Izgara Ölçüleri / Width of Gridiron	220 x 330
Net Ağırlık / Net Weight	16 Kg
Ölçüler / Dimensions	370x480x340 mm

262

- Konveyör dahil AISI 304 paslanmaz çelik
- Fan soğutmalı motor
- Ayarlanabilir alt ve üst ısı
- Isı yansıtıcı iç reflektör sayesinde hızlı ısınma
- Ön ve arka tahliye sayesinde kolay kullanım
- Aşırı ısınma ve yanmaya karşı dahili soğutma fanı
- Aşırı ısınma ve kırılmaya karşı güçlendirilmiş ısıtma parçaları
- AISI 304 stainless steel construction including conveyor
- Fan-cooled motor
- Built-in cooling-fan to prevent overheating and burns
- Reinforced heating elements against burnout and breakage
- Reflecting heating elements for upper and lower heat ensure that the product is quickly and evenly heated
- Upper and lower elements can be selected for perfect golden toasting every time
- Easy to load rack with rear or front discharge

Güç / Power	1300 W
Güç Kaynağı / Power Source	230 V/50 Hz F+N
Izgara Ölçüleri / Width of Gridiron	185x300
Net Ağırlık / Net Weight	12 Kg
Ölçüler / Dimensions	238x330x349 mm



» Kod	Model
Code	Model
63010038	Konveyörlü Ekmek Kızartma Makinesi Conveyor Toaster

- AISI 304 Paslanmaz Çelik
- Uzun süreli kullanım için soğutmalı motor
- Dayanıklı motor redüktörü yağ içinde çalışarak servis ömrünü uzatır
- Çift contalı redüktör
- Kullanışlı hazne kilit sistemi
- Paslanmaz çelik hazne giriş yüksek kalite mamül almak üzere tasarlandı
- Et tepsi özel güvenli kilit sistemine sahip

- AISI 304 stainless steel construction
- Powerful IP 55 insulated and fan-cooled motors for continuous use
- Endless screw motor-reducer running in an oil-bath enables a long service life
- Motor-reducer equipped with a double seal for long, trouble-free service
- Convenient head interlock mechanism (CE versions)
- Stainless steel mincing head carefully designed for high yield production
- Feed tray designed with square neck for outstanding performance
- Feed tray provided with safety interlock (CE versions)
- Stainless steel IP 67 protected controls with reverse.



» Kod
Code
63010070

Model
Model
Kıyma Makinesi
Meat Grinder

263

Güç / Power

Güç Kaynağı / Power Source

Standart Tabla / Standart Plate

Üretim Kapasitesi / Output/h.

İç Kapasite / Inner Dimensions

Net Ağırlık / Net Weight

Ölçüler / Dimensions

1ph W 1100/Hp 1,5 - 3ph W 1472/Hp 2

230-400 V/50Hz

ø mm 4,5

350 kg/saat

480x360x300 mm

36 Kg

512x390x531 mm

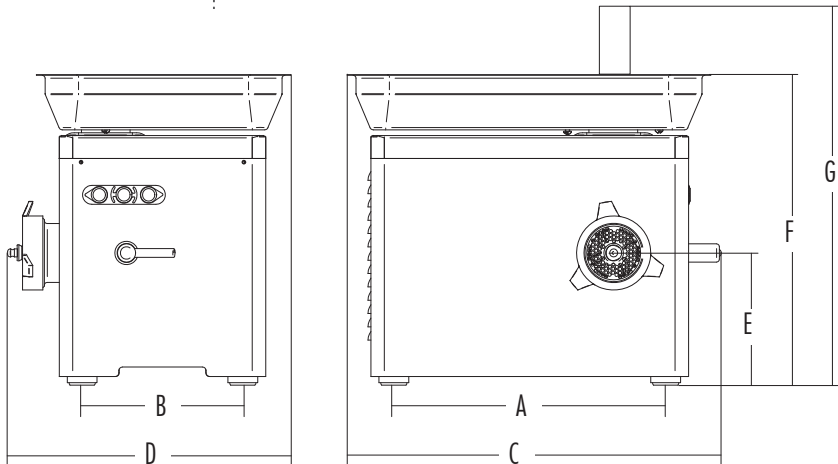

İndüksiyon Ocaklar / Induction Cooker

SIRMAN[®]

Made in Italy



Güç / Power	2500 W
Güç Kaynağı / Power Source	230 V/50-60 Hz F+N
Kullanılabilir Alan / Useful Surface	322x270 mm
Net Ağırlık / Net Weight	7,5 Kg
Ölçüler / Dimensions	A B C 320 mm 440 mm 115 mm

» Kod Code	Model Model
63010080	Gömme İndüksiyon Ocak Built-In Induction Cooker

264

Güç / Power	2500 W
Güç Kaynağı / Power Source	230 V/50-60 Hz F+N
Kullanılabilir Alan / Useful Surface	322x270 mm
Net Ağırlık / Net Weight	9 Kg
Ölçüler / Dimensions	A B C 320 mm 500 mm 115 mm

» Kod Code	Model Model
63010081	İndüksiyon Ocak Induction Cooker



» Kod Code	Model Model
63010082	İndüksiyon Ocak Induction Cooker



Güç / Power	3500 W
Güç Kaynağı / Power Source	230 V/50-60 Hz F+N
Kullanılabilir Alan / Useful Surface	330x275 mm
Net Ağırlık / Net Weight	11 Kg
Ölçüler / Dimensions	A B C 340 mm 460 mm 135 mm



>> Kod
Code

63010019

Model
Model

İndüksiyon Ocak /
Induction Cooker

- Mutfakta, restoranda, yada yemek odalarında her kullanım yüzeyine uygun kurulumu kolay elektrikli ocak ızgara
- Duman bulundurmaması sayesinde umuma açık yerlerde ya da müşteri önünde pişirim yapmaya son derece elverişlidir
- Derecelendirilmiş dijital kontrol
- Kullanım ve temizlemesi çok kolaydır
- Pürüzsüz pişirme yüzeyi temizlemeyi kolaylaştırmaktadır
- Asla aşırı ısınmayan yüzeyi ile oldukça güvenlidir
- Elektrikli ocak ızgara ısıyı etkin kullanması ve asla aşırı ısınmaması sayesinde enerji tasarrufludur
- Tencere ocak üzerinden alındığında elektrik emilimi durur
- The induction hobs are easy to install on every working surface in kitchens, restaurants or dining rooms; thanks to the absence of fumes they are perfect for public cooking performances or when the preparation is made in view of customers
- Graduated digital controls
- Extremely easy to use and to clean
- Smooth cooking surface makes cleaning easy
- Safe operations are ensured by the cooking surface which is never heating up
- Induction hobs are energy saving thanks to heating efficiency and no need to heat up
- Electric absorption is stopped when the pan is removed from the hob surface

265

>> Kod
Code

57103838

Model
Model

Gömme İndüksiyon Ocak /
Built-In Induction Cooker

Güç / Power

3500 W

Güç Kaynağı / Power Source

220-240 V/50-60 Hz F+N

Kullanılabilir Alan / Useful Surface

Ø 280 mm

Ölçüler / Dimensions

A B C
360 mm 380 mm 25 mm



Isıtıcı Plate / Buffet Plates

SIRMAN[®]

Made in Italy

- Kırılmaz cam GN 1/1 yüzey
- Metal, cam ve porselen ürünlerle kullanım
- 90°C'ye çıkabilen ısı (194 °F).
- Isı sabitleme özelliği ile Bain-marie'ye uygun kullanım
- Polisajlı paslanmaz çelik çerçeve
- Büfe ve masa sunumları için uygun dizayn
- Taşımayı kolaylaştıran saplar
- Bain - marie alternative for maintaining the temperature of trays and casserole dishes made of metal, glass and porcelain
- Hot Plate conveniently designed for buffet and table service
- Sturdy polished stainless steel frame
- Convenient handles to easily carry it
- Dial temperature control up to 90 °C (194 °F)
- Gastronorm 1/1 tempered glass



266

Güç / Power	230 Watt
Güç Kaynağı / Power Source	230 V/50 Hz
Isı / Temperature	°C 0 / 90
Kullanılabilir Alan / Useful Surface	530 x 325 mm
Net Ağırlık / Net Weight	4,5 Kg
Ölçüler / Dimensions	A B C 610 mm 370 mm 45 mm

» Kod
Code
63010053

Model
Model
Sıcak Tutucu Plate / Buffet Plate



- AISI 304 paslanmaz çelik
- Sertleştirilmiş cam yüzey
- 0 - 60°C termostatlı ısı ayarı
- Pilot ışık
- Darbeye dayanıklı ısıtma parçaları

- Sturdy and compact structure
- Made from AISI 304 stainless steel
- Shock-proof heating elements
- Temperature adjustable by means of a thermostat ranging from 0 to 60°C
- Pilot light

Güç / Power	430 Watt
Güç Kaynağı / Power Source	230 V/50-60 Hz F+N
Isı / Temperature	°C 0 / 60
Net Ağırlık / Net Weight	13,4 Kg
Ölçüler / Dimensions	A B C 500 mm 500 mm 90 mm

» Kod
Code
63010052

Model
Model
Pizza Isıtıcı / Pizza Warmer



- Güçlendirilmiş soğutmalı motor
- 20 adet ön-ayarlanabilir program
- 9 adet özel ayarlanabilir program seçeneği
- Program akışını ve makinenin çalışmasını görüntüleyen ekran
- 2 Litre kapasiteli, bulaşık makinasında yıkanabilir şeffaf hazne
- Dereceli hazne ve sızdırmaz kauçuk kapak
- Paslanmaz çelik 4 başlı bıçak
- Barmaster Q için;
- Pratik kullanım için 3 ayrı noktadan dökme imkanı
- Frozen ve Smoothie içecekler hazırlamak için mükemmel uyum

- 20 pre-set programs, of which 4 can be linked to 4 keys on the keypad and the other 16 can be recalled through the menu (all can be reprogrammed)
- 9 programs set in self-learning mode
- Display to view the programs and machine operation
- The square glass has been developed to ideally work with large quantities of ice, even dry
- 2 litre capacity, built out of transparent, indestructible Tritan, can be washed in dishwasher, graduated in litres, UK and U.S. gallons
- Glass lid in rubber with airtight seal with cap and graduated glass
- Knife support in stainless steel that can be fully and easily disassembled from the glass body. Knife with 4 spokes obtained from a single mould in tempered cutlery steel, easy to disassemble

Soğutmalı Motor
Ventilated Motor

Kod Code	Model Model
63010015	Kare Hazneli / Square Jug
63020015	Ses Geçirmez Kare Hazneli / Square Jug w/Sound Enclose
63010041	Ses Geçirmez Yuvarlak Hazneli / Round Jug w/Sound Enclose



Güç / Power

750 W - Hp 1

Güç Kaynağı / Power Source

230 V/50-60 Hz F+N

Motor / Motor

r.p.m. 14.000+24.000

Hazne Kapasitesi / Jug Capacity

2 Lt

Net Ağırlık / Net Weight

5 Kg

Ölçüler / Dimensions

A	B	C	D	E	F	G	H
200 mm	200 mm	485 mm	240 mm	230 mm	535 mm	315 mm	670 mm

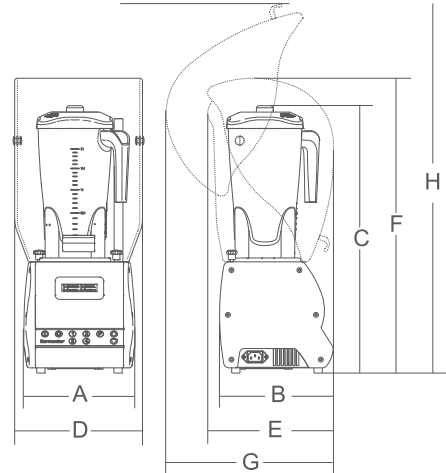

- Güçlendirilmiş soğutmalı motor
- Mekanizmadaki sert kauçuk sayesinde sessiz çalışma
- Kapakta mıknatıslı güvenlik kilidi
- Hız kontrollü açma kapama düğmesi
- 2 litre kapasiteli, bulaşık makinasında yıkanabilir şeffaf hazne
- Cam hazneden kolayca ayrılabilen paslanmaz çelik bıçak desteği
- Paslanmaz çelik 4 başlı bıçak
- Machine structure in extruded aluminium and sides in ABS with 1 or 2 glasses for the aluminium version and machine structure in stainless steel for the stainless steel version
- Powerful motor with forced ventilation, for prolonged use and enhanced durability
- Reliable low-noise transmission system in vulcanized rubber
- Magnetic safety micro-switch on glass lid without forced position
- 2 litre capacity, built out of transparent, indestructible Tritan, can be washed in dishwasher, graduated in litres, UK and U.S. gallons, or 2 litre and 5 litre glass in stainless steel for the Five version
- Glass lid in rubber or polyester for Orion Five, both with airtight seal with cap and graduated glass
- Knife support in stainless steel that can be fully and easily disassembled from the glass body

Soğutmalı Motor
Ventilated Motor» Kod
Code63010014
63010040Model
ModelYuvarlak Hazneli / Round Jug
Kare Hazneli / Square Jug

269

Volkanize kauçuk mekanizma
Vulcanized rubber gearsMilkshake aparatı
Milkshake application

Güç / Power

750 W - Hp 1

Güç Kaynağı / Power Source

230 V/50-60 Hz F+N

Motor / Motor

r.p.m. 14.000+24.000

Hazne Kapasitesi / Jug Capacity

2 Lt

Net Ağırlık / Net Weight

5 Kg

Ölçüler / Dimensions

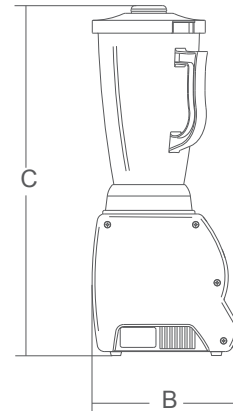
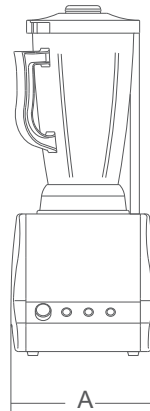
A B C
200 mm 200 mm 470 mm

İçecek Mikseri / Beverage Mixer

SIRMAN[®]

Made in Italy

- Yüksek güçlü, soğutmalı motor
- Şeffaf, 1,5 Litrelik, bulaşık makinesinde yıkanabilen hazne
- Çalışma esnasında malzeme eklemeye uygun sızdırmaz kapak
- Sertleştirilmiş kauçuk dişliler ile yüksek güç iletimi ve sessiz çalışma
- 4 parçalı sökülebilir paslanmaz çelik bıçak
- Kapakta emniyet kilidi
- Powerful ventilated motor
- Transparent, unbreakable 1,5 Lt Tritan container is dishwasher safe and graduated with litres and gallons
- Tight rubber lid with feed opening to add ingredients while the blender is working
- Vulcanized rubber gears drive gives a high power transmission and quiet operation
- 4-blades stainless steel knife can be easily disassembled
- Safety microswitch on the lid



Soğutmalı Motor
Ventilated Motor



Güç / Power	450 W - Hp 0,60
Güç Kaynağı / Power Source	230 V 50/60 Hz F+N
Motor / Motor	r.p.m. 18.000
Hazne Kapasitesi / Jug Capacity	0,55 Lt
Net Ağırlık / Net Weight	3 Kg
Ölçüler / Dimensions	213x200x416 mm

» Kod
Code
63010013

Model
Model
Blender

270



- Şeffaf 550 cc Tritan hazne
- Daha uzun ömür için soğutmalı motor
- Kokteyl ya da içecek hazırlamak için üç alüminyum pimli ve paslanmaz çelik başlıklı karıştırıcı ya da donmuş kahve veya kremli sonuçlar için özel yuvarlak karıştırıcı
- Hazne mekanizmasında güvenlik kilidi

- Transparent 550 cc Tritan cup or stainless steel cup on request
- 900 cc stainless steel cup on 120 W version
- Powerful ventilated motor for a longer life
- Spindle with three aluminium and s/steel agitators for preparing cocktails and drinks, or with a special round agitator for frozen coffees or for creamier results
- Safety microswitch on the cup support

Güç / Power	100 W
Güç Kaynağı / Power Source	230 V 50/60 Hz F+N
Motor / Motor	r.p.m. 14.000
Hazne Kapasitesi / Jug Capacity	0,55 Lt
Net Ağırlık / Net Weight	2,5 Kg
Ölçüler / Dimensions	150x195x485 mm

» Kod
Code
63010011

Model
Model
İçecek Mikseri / Beverage Mixer

- Yuvarlak tasarımlı , ticari kullanıma uygun
- Krom gövde, kolay temizlik için köşesiz ve eksiz tasarım
- Sökülebilir paslanmaz çelik hazne kolay temizlenebilir ve bulaşık makinasında kullanıma uygun
- Maksimum verimlilik için tek parça sıkacak ve süzgeç
- Gıda temasını önlemek için alüminyum paslanmaz çelik seviye ayarlayıcı
- Meyve aşağı itildiğinde cihazın çalışmasını sağlayan patentli güvenlik şalteri
- Commercial easy to use citrus juicer with round design
- Chrome body, no edges or seams for easy cleaning
- Stainless steel bowl is removable for cleaning and is dishwasher safe, ABS bowl available on request
- Reamer and sieve are one piece to squeeze with the maximum efficiency
- Aluminium stainless steel lever to avoid any food contact is available on request
- Patented safety microswitch on the cone allows to activate the juicer when the product is pushed down
- The juicer is available without microswitch as well
- Speed control on request

» Kod
Code

63010016

Model
Model

Narenciye Sıkacağı / Citrus Juicer

Güç / Power	150 W
Güç Kaynağı / Power Source	230 V /50-60 Hz F+N
Devir/Dakika / Revolutions/min.	r.p.m. 320
Net Ağırlık / Net Weight	3 Kg
Ölçüler / Dimensions	210x210x280 mm

» Kod
Code

63010017

Model
Model

Narenciye Sıkacağı Kapaklı / Citrus Juicer w/Lever

- Yuvarlak tasarımlı , ticari kullanıma uygun
- Krom gövde, kolay temizlik için köşesiz ve eksiz tasarım
- Sökülebilir paslanmaz çelik hazne kolay temizlenebilir ve bulaşık makinasında kullanıma uygun
- Maksimum verimlilik için tek parça sıkacak ve süzgeç
- Gıda temasını önlemek için alüminyum paslanmaz çelik seviye ayarlayıcı
- Meyve aşağı itildiğinde cihazın çalışmasını sağlayan patentli güvenlik şalteri
- İsteğe bağlı hız kontrolü
- Mikroanahtarsız sızıcı da mevcuttur

- Commercial easy to use citrus juicer with round design
- Chrome body, no edges or seams for easy cleaning
- Stainless steel bowl is removable for cleaning and is dishwasher safe, ABS bowl available on request
- Reamer and sieve are one piece to squeeze with the maximum efficiency
- Aluminium stainless steel lever to avoid any food contact is available on request
- Patented safety microswitch on the cone allows to activate the juicer when the product is pushed down
- The juicer is available without microswitch as well
- Speed control on request

Güç / Power	150 W
Güç Kaynağı / Power Source	230 V /50-60 Hz F+N
Devir/Dakika / Revolutions/min.	r.p.m. 320
Net Ağırlık / Net Weight	3,5 Kg
Ölçüler / Dimensions	210x210x280 mm

Buz Kırıcı / Ice Crusher

SIRMAN[®]

Made in Italy

- Çekme alüminyum iskelet, ABS gövde
 - Kuru buz için ideal
 - Buz kalınlığı ayarlama
 - Buzu direk bardağa dökebilme kolaylığı
 - Mikroswitch kapaklı paslanmaz çelik 3 lt hazne
 - 800 r.p.m. (devir)
 - Bronzdan imal dişli motor redüktörü
- Professional ice crusher, an indispensable bar tool for preparing drinks and frozen cocktails and in the restaurant for displaying fish or fresh foods
 - Crushes any ice cubes made with an ice cube machine up to 40x40mm at -3° C
 - Its discharge adjustment lets you regulate the average size of the crushed ice
 - Extruded aluminium body, stainless steel container, food-grade ABS opening and s/steel blades
 - Ventilated motor with gear transmission for prolonged use, micro-switch on the lid for maximum operator safety



272

> Kod Code	Model Model
63010039	Buz Kırıcı / Ice Crusher



Güç / Power

150 W

Güç Kaynağı / Power Source

230 V 50/60 Hz F+N

Bıçak Hızı / Blade Speed

r.p.m. 800

Hazne Kapasitesi / Jug Capacity

3 Lt

Net Ağırlık / Net Weight

5,2 Kg

Ölçüler / Dimensions

A B C D
205 mm 285 mm 491 mm 235 mm

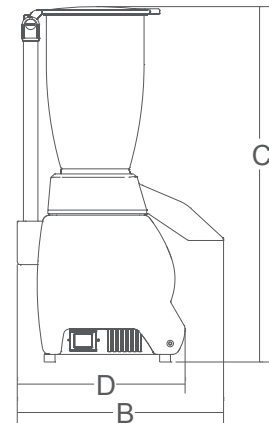
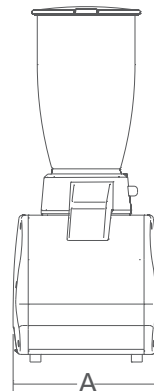

- Triton bıçağı ayarlamayla buzı farklı boyutlarda kırmayı sağlar
- Geleneksel İtalyan granitası için düzgün kırılmış buz
- Buzlu kokteyller veya soğuk mezelerin servis ve sunumu için kar buzları
- Besleme ağzında mikro güvenlik anahtarı
- Toplama haznesinde mikro güvenlik anahtarı
- Polisajlı alüminyum besleme ağız
- Paslanmaz çelik parça ve ayrıntılar
- Alüminyum ve paslanmaz çelik iç yapı
- Termo formlu gıdaya uygun plastikten gövde ve hazne
- Düşük emiş gücü için oluklu kayış

- Triton allows to crush ice in different sizes by adjusting the blade:
 - Finely crushed ice for the traditional Italian granitas
 - Flakes for frozen cocktails or to serve or display cold dishes
- Safety microswitch on the feeding mouth
- Safety microswitch on the collecting tray
- Polished aluminium feeding mouth
- Stainless steel parts and details
- Aluminium and stainless steel internal structure
- Body and tray are made from thermoformed alimentary plastic
- Ribbed belt for low power absorption.



» Kod
Code

63010018

Model
Model

Buz Kırıcı / Ice Crusher



Kesme kalınlığı ayarlama kolu
Cut thickness adjusting knob



Mikro anahtarlı hazne
Collecting tray with microswitch



Besleme ağzında mikro güvenlik anahtarı
Microswitch on the lever

273

Güç / Power

350 W

Güç Kaynağı / Power Source

230 V/50-60 Hz F+N

Motor / Motor

r.p.m. 12000

Bıçak Hızı / Blade Speed

r.p.m. 1500

Max. Buz Kalınlığı / Crushed Ice Max. Thickness

10 mm

Hazne Kapasitesi / Jug Capacity

2 Lt

Net Ağırlık / Net Weight

8,5 Kg

Ölçüler / Dimensions

A B C D E
365 mm 210 mm 465 mm 295 mm 480 mm

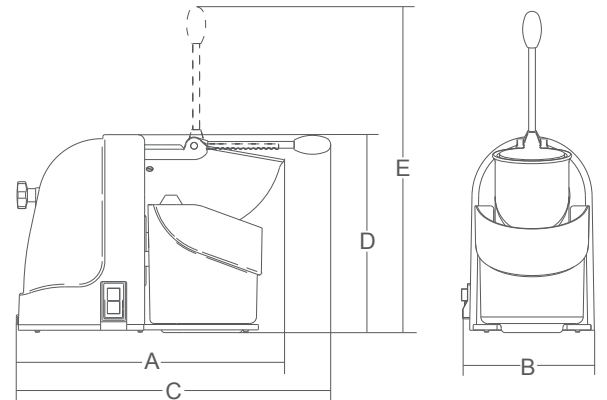



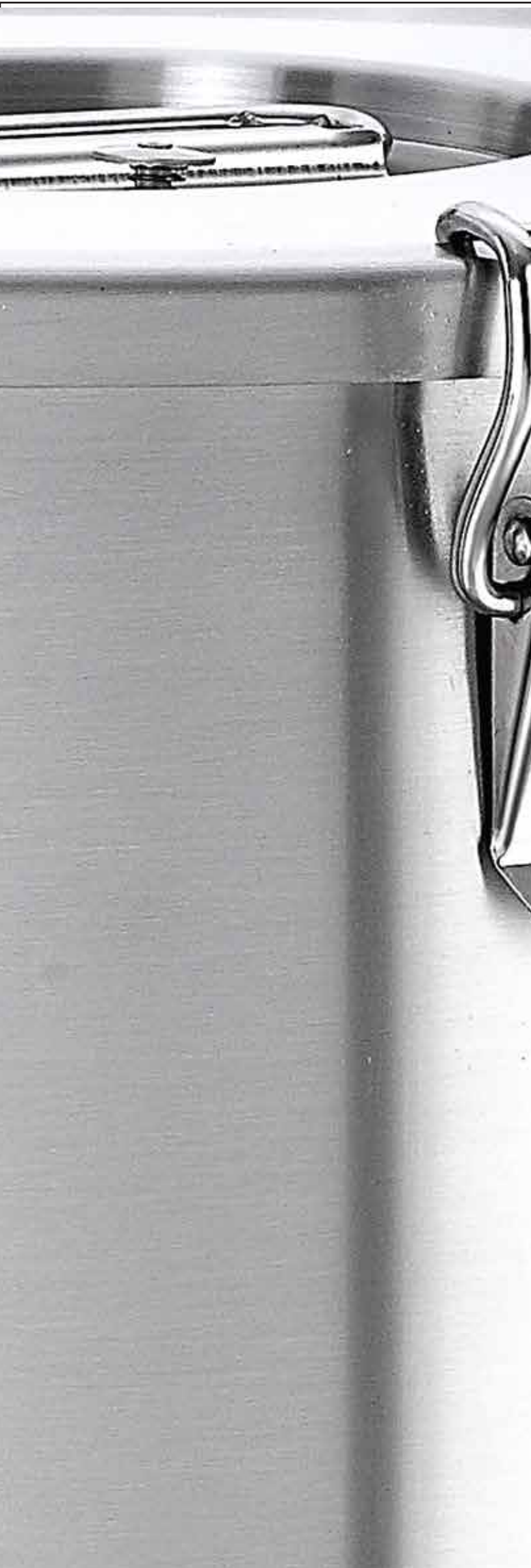

Taşıma

Carrying

Taşıma Kovaları / Carrying Containers



- » Tabansız (Kapaklı)
w/o Sandwich Bottom

Kod Code	Øxh (cm) Øxh (cm)	Lt Lt
35512428	24x28	12,5
35513028	30x28	20
35513032	30x32	21
35513636	36x36	36,6
35514040	40x40	50
35514545	45x45	70
35515050	50x50	100



- » Tabansız (Silikon Conta Kapaklı)
w/o Sandwich Bottom-Lid w/Silicone Seal

Kod Code	Øxh (cm) Øxh (cm)	Lt Lt
35532428	24x28	12,5
35533028	30x28	20
35533032	30x32	21
35533636	36x36	36,6
35534040	40x40	50
35534545	45x45	70

* Ø36, Ø40, Ø45 ölçüleri sabit saplıdır
* Ø36, Ø40, Ø45 has fixed handles



- » Tabanlı (Kapaklı)
w/Sandwich Bottom

Kod Code	Øxh (cm) Øxh (cm)	Lt Lt
35502428	24x28	12,5
35503028	30x28	20
35503032	30x32	21
35503636	36x36	36,6
35504040	40x40	50
35504545	45x45	70
35505050	50x50	100

* Ø36, Ø40, Ø45 ölçüleri sabit saplıdır
* Ø36, Ø40, Ø45 has fixed handles

276



- » Tabanlı (Silikon Conta Kapaklı)
w/Sandwich Bottom-Lid w/Silicone Seal

Kod Code	Øxh (cm) Øxh (cm)	Lt Lt
35542428	24x28	12,5
35543028	30x28	20
35543032	30x32	21
35543636	36x36	36,6
35544040	40x40	50
35544545	45x45	70



- » İzoleli
Double Wall Container

Kod Code	Øxh (cm) Øxh (cm)	Lt Lt
35503217	32x17	10
35503222	32x22	14
35503230	32x30	20
35503236	32x36	24
35503248	32x48	32
35505030	50x30	43



- » Musluklu
Container w/Faucet

Kod Code	Øxh (cm) Øxh (cm)	Lt Lt
35412428	24x28	12,5
35413028	30x28	20
35413032	30x32	21
35413636	36x36	36,6
35414040	40x40	50
35414545	45x45	70
35415050	50x50	100

- » Silikon Conta
Silicone Seals



Kod Code	Ø (cm) Ø (cm)
35510024	24
35510030	30
35510036	36
35510040	40
35510045	45

* Gıda tüzüğüne uygundur.
* Food safe compliances.





» Sefer Tası Standart

Standard

Kod Code	Øxh (cm) Øxh (cm)	AdxLt PcsxLt
30631808	18x8x3	3x2
30641808	18x8x4	4x2
30632010	20x9x3	3x3
30642010	20x9x4	4x3
30632414	24x14x3	3x6
30642414	24x14x4	4x6
30633014	30x14x3	3x10
30643014	30x14x4	4x10



» Sefer Tası İzoleli

Double Wall

Kod Code	Øxh (cm) Øxh (cm)	AdxLt PcsxLt
35502092	20x11x2	2x3
35502093	20x11x3	3x3
35502094	20x11x4	3x4

277



» Tasıma Tepsisi Kapaklı

Carrying Tray-on Cover

Kod Code	Ölçü (cm) Dim. (cm)
30714565	30714565
30714568	30714568
30714561	30714561
30715355	30715355
30715358	30715358
30715310	30715310
30715705	30715705
30715708	30715708
30715710	30715710



» Tasıma Tepsisi Kapaksız

Carrying Tray

Kod Code	Ölçü (cm) Dim. (cm)
30704565	40x60x5
30704568	40x60x8
30704561	40x60x10
30705355	50x35x5
30705358	50x35x8
30705310	50x35x10
30705705	50x70x5
30705708	50x70x8
30705710	50x70x10

- Bulaşık makinesinde yıkanabilir
- +100°C ısıya, -40°C soğuğa dayanıklıdır
- Kolay temizlenebilir ve hijyenik parlak ve pürüzsüz iç yüzey
- Ekstra güçlendirilmiş köşeler
- 53 lt-63 lt arası taşıma kapasitesi
- Hafif gövde yapısı sayesinde kolay taşınabilirlik
- Üst üste dizilebilir
- Çift cidarlıdır. Cidarlar arasında poliüretan köpük kullanılmıştır
- İnsan sağlığına zararlı madde içermemektedir
- Talebe göre renk seçenekleriyle üretilebilir

- Dishwasher safe
- Can withstand temperatures from -40°C to +100°C
- Smooth inside surface that is hygienic and easy to clean
- Features tough reinforced corners
- Can carry from 53 to 63 lt
- Light case that is easy to lift
- Stackable
- Double walls filled with polyurethane foam
- Does not contain any substances harmful to human health
- Other colours available upon request

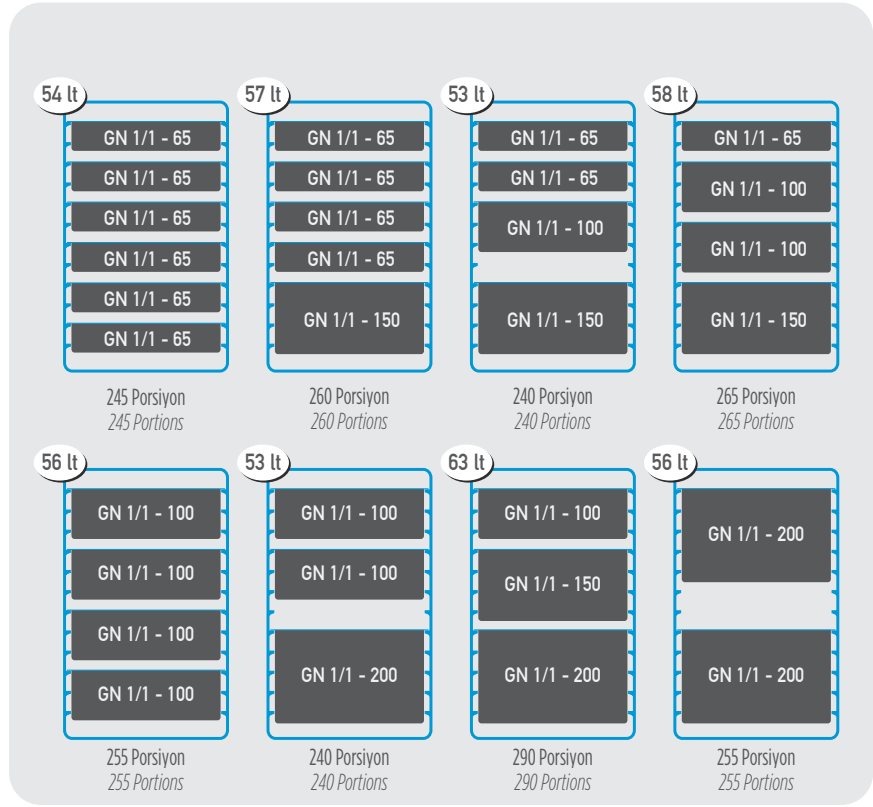

278



4 adet 10 cm derinlikte követlerde 88°C'lik sıcak su ve 0.5°C'lik soğuk su ile test edilmiştir.
Tested with four 10 cm deep trays filled with hot water at 88°C and with cold water at 0.5°C.

TESTLER TESTS	SICAK HOT					SOĞUK COLD				
	Başlangıç Start	1 Saat 1 Hour	2 Saat 2 Hour	3 Saat 3 Hour	4 Saat 4 Hour	1 Saat 1 Hour	2 Saat 2 Hour	3 Saat 3 Hour	4 Saat 4 Hour	5 Saat 5 Hour
	88°C	83°C	81.9°C	80.2°C	79°C	0.5°C	1°C	1.5°C	2°C	2.4°C



*Renk Seçenekleri
*Colour options



İç Ölçüler / Inner Dimensions : 33x52x50 cm
 Dış Ölçüler / Outer Dimensions : 44x66x63 cm
 Ağırlık / Weight : 14 Kg

» Thermobox 600 Mentesele
 Thermobox 600 (Side-Hinged)

Kod
 Code
 46011600



279



İç Ölçüler / Inner Dimensions : 33x52x50 cm
 Dış Ölçüler / Outer Dimensions : 44x66x63 cm
 Ağırlık / Weight : 13,5 Kg

» Thermobox 600
 Thermobox 600

Kod
 Code
 46010600



* Önden yüklemeli model. Max. GN 1/1 kütvet kullanımına uygundur.
 * Front loading model. Designed for GN Food Pan Standards.

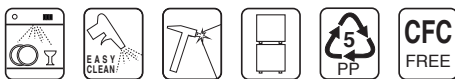

■ ■ ■ ■ ■ *Renk Seçenekleri
 *Colour options



» İçecek Thermobox
Beverage Thermobox

Kod Code	Lt Lt
43020300	23



» Yiyecek & İçecek Thermobox
Food & Beverage Thermobox

Kod Code	Lt Lt
43020250	33

280



* Üstten yüklemeli model. Max. GN 1/1 kuvvet kullanımına uygundur.
* Overhead loading model. Designed for GN Food Pan Standards

» Thermobox
Standard

Kod Code	Ölçü (mm) Dim. (mm)	Model Model
43020100	635x435x200	Max. GN 1/1-100
43120100	635x435x200	Max. GN 1/1-100
43220100	635x435x200	Max. GN 1/1-100
43320100	635x435x200	Max. GN 1/1-100
43020150	635x435x250	Max. GN 1/1-150
43120150	635x435x250	Max. GN 1/1-150
43220150	635x435x250	Max. GN 1/1-150
43320150	635x435x250	Max. GN 1/1-150
43020200	635x435x310	Max. GN 1/1-200
43120200	635x435x310	Max. GN 1/1-200
43220200	635x435x310	Max. GN 1/1-200
43320200	635x435x310	Max. GN 1/1-200

430 431 432 433
■ ■ ■ ■



* Aksesuarlar hariçtir
* w/o Accessories

» Termo Tepsi
Isothermic Tray

Kod Code	Ölçü (mm) Dim. (mm)	Model Model
43020105	530x370x120	5 Gözlü 5 Partition
43020106	530x370x120	6 Gözlü 6 Partition



Servis Arabası (Açık)
» Serving Trolley

Kod Code	Ölçü (cm) Dim. (cm)
46010028	107x52x96

* Kovalar fiyata dahil değildir.
* Kovalar fiyata dahil değildir.



» Servis Arabası (Kapalı)
Serving Trolley (Closed)

Kod Code	Ölçü (cm) Dim. (cm)
46010027	98x53x93



Servis Arabası Kahverengi (Açık)
» Serving Trolley Brown

Kod Code	Ölçü (cm) Dim. (cm)
46110028	107x52x96

* Kovalar fiyata dahil değildir.
* Kovalar fiyata dahil değildir.



» Servis Arabası Kahverengi (Kapalı)
Serving Trolley Brown (Closed)

Kod Code	Ölçü (cm) Dim. (cm)
46110027	98x53x93

281



» 5 Katlı Açık Servis Rafı
Serving Trolley 5 Shelved

Kod Code	Ölçü (cm) Dim. (cm)
46011029	160x80x50



» 5 Katlı Kapalı Servis Rafı
Serving Trolley 5 Shelved (Closed)

Kod Code	Ölçü (cm) Dim. (cm)
46011030	160x80x50



» 2 Katlı Servis Arabası (Demonte)
Demontable Service Trolley

Kod Code	Ölçü (cm) Dim. (cm)
34266018	90x60x18



» 3 Katlı Servis Arabası (Demonte)
Demontable Service Trolley

Kod Code	Ölçü (cm) Dim. (cm)
34266022	90x60x22

282



» 3 Katlı Servis Arabası (Monoblok)
Monoblock Service Trolley

Kod Code	Ölçü (cm) Dim. (cm)
43010002	98x58,5x88

* Çöp aparatı hariçtir.
* w/o Waste bin.



» Çöp Kovası
Waste Bin

Kod Code	Ölçü (cm) Dim. (cm)
43010011	33,5x23x44,5



» Tekerlek
Wheel

Kod Code	Ölçü (mm) Dim. (mm)
46011031	40x40x30



» Küver Kabı
Cutlery Bin

Kod Code	Ölçü (cm) Dim. (cm)
43010012	33,5x23x18



» Taşıma Kutusu
Bus Box

Kod Code	Ölçü (cm) Dim. (cm)
60020010	54x39x20



» Çatal Kaşık Kutusu
4 Compartment Cutlery Holder

Kod Code	Ölçü (cm) Dim. (cm)
60020011	52x29x9,5

* Tüm ürünler servis arabaları üzerinde kullanıma uygun ebatlardadır.
* All products are suitable for serving trolleys.

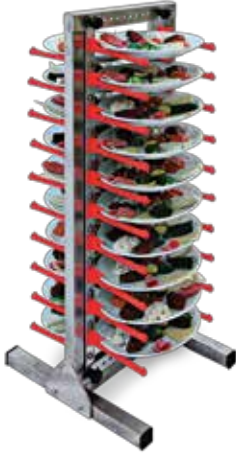

» Tabak İstif Ünitesi
Table Top Plate Rack

Kod Code	Kapasite Capacity
43010015	20 Tabak 20 Plate

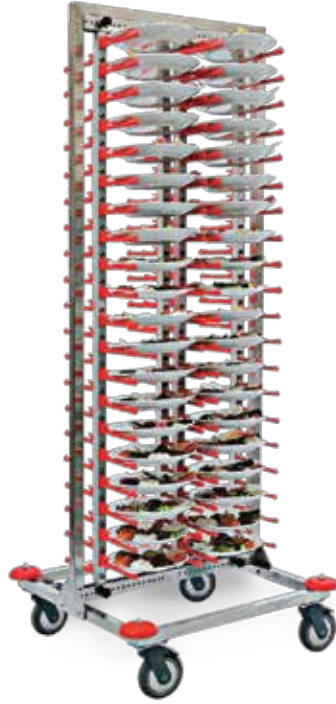

» Tabak İstif Arabası
Mobile Plate Rack

Kod Code	Kapasite Capacity
43010014	80 Tabak 80 Plate



» Kaset Taşıma Arabası
Rack Trolley

Kod Code	Kapasite Capacity	Ölçü (cm) Dim. (cm)
48010005	5 Kaset 5 Rails	37x53
48010010	10 Kaset 10 Rails	37x53

283



» Tabak Taşıma Arabası Ayarlanabilir
Adjustable Dish Dolly

Kod Code
43010013



plast|port

» Erzak Arabası
Ingredient Bin w/Sliding Lid

Kod Code	Lt	Ölçü (cm) Dim. (cm)
46010010	102	42x75x71



» Et Taşıma Arabası
Meat Carrying Dolly

Kod Code	Kapasite Capacity	Ölçü (cm) Dim. (cm)
46010010	200 Kg	56x55x50



» Bulaşık Toplama Arabası
Utility Rack

Kod Code	Model Model	Kapasite Capacity	Ölçü (cm) Dim. (cm)
48013753	Tekli Single	13 Ad. 37x53 Tepsi 13 Pcs. 37x53 Tray	43x56x171
48023753	İkili Double	26 Ad. 37x53 Tepsi 26 Pcs. 37x53 Tray	83x56x171
48033753	Üçlü Triple	39 Ad. 37x53 Tepsi 39 Pcs. 37x53 Tray	123x56x171
48043753	Dörtlü Quadruple	52 Ad. 37x53 Tepsi 52 Pcs. 37x53 Tray	175x77x171



» Tepsi Taşıma Arabası
Tray Cart

Kod Code	Model Model	Kapasite Capacity	Ölçü (cm) Dim. (cm)
48014060	Tekli Single	15 Ad. 40x60 Tepsi 15 Pcs. 40x60 Tray	40x63x165
48024060	İkili Double	30 Ad. 40x60 Tepsi 30 Pcs. 40x60 Tray	90x63x165
48015070	Tekli Single	15 Ad. 50x70 Tepsi 15 Pcs. 50x70 Tray	56x73x170

284

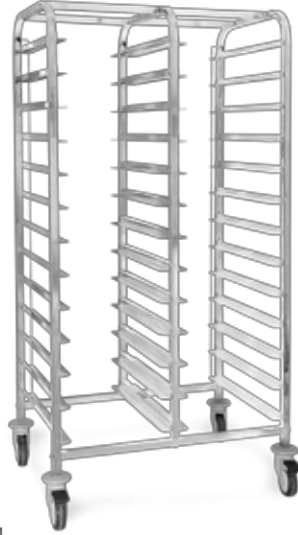

» Tepsi Taşıma Arabası GN 1/1
Tray Cart GN 1/1

Kod Code	Model Model	Kapasite Capacity	Ölçü (cm) Dim. (cm)
48011009	Tekli Single	9 Ad. GN 1/1 Tepsi 9 Pcs. GN 1/1 Tray	38x56x105
48011017	Tekli Single	17 Ad. GN 1/1 Tepsi 17 Pcs. GN 1/1 Tray	38x56x172
48011034	İkili Double	34 Ad. GN 1/1 Tepsi 34 Pcs. GN 1/1 Tray	74x56x172



» Tepsi Taşıma Arabası GN 2/1
Tray Cart GN 2/1

Kod Code	Model Model	Kapasite Capacity	Ölçü (cm) Dim. (cm)
48012109	Tekli Single	9 Ad. GN 2/1 Tepsi 9 Pcs. GN 2/1 Tray	59x68x105
48012117	Tekli Single	17 Ad. GN 2/1 Tepsi 17 Pcs. GN 2/1 Tray	59x68x172
48012134	İkili Double	34 Ad. GN 2/1 Tepsi 34 Pcs. GN 2/1 Tray	115x68x172

- Konveksiyon ısı, 230V/1350 W / Convection heating, 230V/1350 W
- 55°C' den 80°C'ye kadar ayarlanabilir / Adjustable thermostat from 55 °C to 80 °C
- 15 dakika ısınma süresi / 15 mins. heating time

» Sıcak SDX Thermobox

Heating SDX Thermobox

Kod Code	Model Model	Ölçü (cm) Dim. (cm)
41030015	8 Bölmeli 8 Shelves	53x76,5x118,5
41030018	12 Bölmeli 12 Shelves	53x76,5x132,5
41030014	14 Bölmeli 14 Shelves	53x76,5x148,5



- Aktif soğutma, 230V/245 W / Active refrigeration, 230V/245 W
- Patentli Peltier Teknolojisi / Patented Peltier Technology
- Yaklaşık 60 dakikada 2-3 °C'ye kadar soğuma / Cooling to 2-3 °C in 60 mins.

» Soğuk SDX Thermobox

Chill SDX Thermobox

Kod Code	Model Model	Ölçü (cm) Dim. (cm)
41031008	8 Bölmeli 8 Shelves	53x80,5x118,7
41031012	12 Bölmeli 12 Shelves	53x80,5x129
41031014	14 Bölmeli 14 Shelves	53x82,5x136



» Soğuk/Sıcak SDX Thermobox

Combination SDX Thermobox

Kod Code	Model Model	Ölçü (cm) Dim. (cm)
41032010	4+6 Bölmeli 4+6 Shelves	53x80,5x118,7
41032012	4+8 Bölmeli 4+8 Shelves	53x80,5x129
41032024	12+12 Bölmeli 12+12 Shelves	53x82,5x136



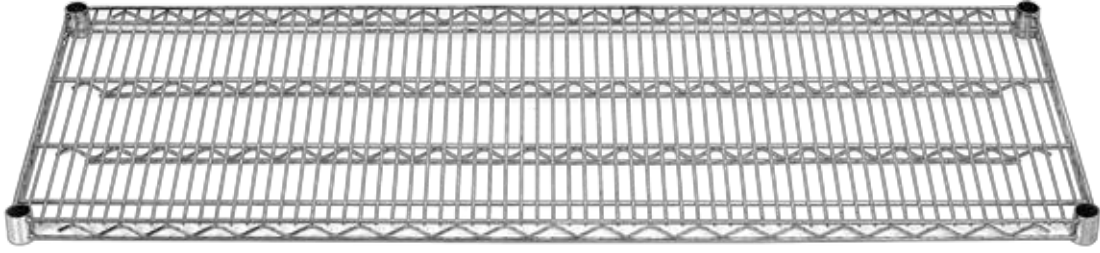

» Tel Raf

Perforated Shelves

Kod Code	Ölçü (mm) Dim. (mm)
50204661	360x610
50204676	360x760
50204691	360x910
50246107	360x1070
50246122	360x1220
50246137	360x1370
50246152	360x1520
50246183	360x1830

» Tel Raf

Perforated Shelves

Kod Code	Ölçü (mm) Dim. (mm)
50204661	460x610
50204676	460x760
50204691	460x910
50246107	460x1070
50246122	460x1220
50246137	460x1370
50246152	460x1520
50246183	460x1830

286

» Tel Raf

Perforated Shelves

Kod Code	Ölçü (mm) Dim. (mm)
50205361	530x610
50205376	530x760
50205391	530x910
50253107	530x1070
50253122	530x1220
50253137	530x1370
50253152	530x1520
50253183	530x1830

» Tel Raf

Perforated Shelves

Kod Code	Ölçü (mm) Dim. (mm)
50206161	610x610
50206176	610x760
50206191	610x910
50261107	610x1070
50261122	610x1220
50261137	610x1370
50261152	610x1520
50261183	610x1830

» Yükseltici

Elevator

Kod Code	Ölçü (mm) Dim. (mm)
50201600	1600
50201800	1800



Tel Raflar 4 Katlı / Perforated Shelves w/4 Floor



» Tel Raf 4 Katlı

Perforated Shelves w/4 Floor

Kod Code	Ölçü (mm) Dim. (mm)
50503661	360x610x1600
50503676	360x760x1600
50503691	360x910x1600
50536107	360x1070x1600
50536122	360x1220x1600
50536137	360x1370x1600
50536152	360x1520x1600
50536183	360x1830x1600

» Tel Raf 4 Katlı

Perforated Shelves w/4 Floor

Kod Code	Ölçü (mm) Dim. (mm)
50504661	460x610x1600
50504676	460x760x1600
50504691	460x910x1600
50546107	460x1070x1600
50546122	460x1220x1600
50546137	460x1370x1600
50546152	460x1520x1600
50546183	460x1830x1600

» Tel Raf 4 Katlı

Perforated Shelves w/4 Floor

Kod Code	Ölçü (mm) Dim. (mm)
50505361	530x610x1600
50505376	530x760x1600
50505391	530x910x1600
50553107	530x1070x1600
50553122	530x1220x1600
50553137	530x1370x1600
50553152	530x1520x1600
50553183	530x1830x1600

» Tel Raf 4 Katlı

Perforated Shelves w/4 Floor

Kod Code	Ölçü (mm) Dim. (mm)
50506161	610x610x1600
50506176	610x760x1600
50506191	610x910x1600
50561107	610x1070x1600
50561122	610x1220x1600
50561137	610x1370x1600
50561152	610x1520x1600
50561183	610x1830x1600

» Tel Raf 4 Katlı

Perforated Shelves w/4 Floor

Kod Code	Ölçü (mm) Dim. (mm)
50703661	360x610x1800
50703676	360x760x1800
50703691	360x910x1800
50736107	360x1070x1800
50736122	360x1220x1800
50736137	360x1370x1800
50736152	360x1520x1800
50736183	360x1830x1800

287

» Tel Raf 4 Katlı

Perforated Shelves w/4 Floor

Kod Code	Ölçü (mm) Dim. (mm)
50704661	460x610x1800
50704676	460x760x1800
50704691	460x910x1800
50746107	460x1070x1800
50746122	460x1220x1800
50746137	460x1370x1800
50746152	460x1520x1800
50746183	460x1830x1800

» Tel Raf 4 Katlı

Perforated Shelves w/4 Floor

Kod Code	Ölçü (mm) Dim. (mm)
50705361	530x610x1800
50705376	530x760x1800
50705391	530x910x1800
50753107	530x1070x1800
50753122	530x1220x1800
50753137	530x1370x1800
50753152	530x1520x1800
50753183	530x1830x1800

» Tel Raf 4 Katlı

Perforated Shelves w/4 Floor

Kod Code	Ölçü (mm) Dim. (mm)
50706161	610x610x1800
50706176	610x760x1800
50706191	610x910x1800
50761107	610x1070x1800
50761122	610x1220x1800
50761137	610x1370x1800
50761152	610x1520x1800
50761183	610x1830x1800





Bulaşık Yıkama

Dish
Washing

» Termo Tepsi

Plate/Trays Rack

Kod	Ölçü (mm)
Code	Dim. (mm)
4303001	500x500x100



» Çatal Kaşık Basketi

Cutlery Rack

Kod	Ölçü (mm)
Code	Dim. (mm)
4303002	500x500x100



» Düz Bardak Basketi

Glass Rack

Kod	Ölçü (mm)
Code	Dim. (mm)
4303003	500x500x100



» Bardak Basketi 9 Bölmeli

9 Compartment Base

Kod	Ölçü (mm)
Code	Dim. (mm)
4300309	500x500x100



» Bardak Basketi 16 Bölmeli

16 Compartment Base

Kod	Ölçü (mm)
Code	Dim. (mm)
43003016	500x500x100



» Bardak Basketi 25 Bölmeli

25 Compartment Base

Kod	Ölçü (mm)
Code	Dim. (mm)
43003025	500x500x100



» Bardak Basketi 36 Bölmeli

36 Compartment Base

Kod	Ölçü (mm)
Code	Dim. (mm)
43003036	500x500x100

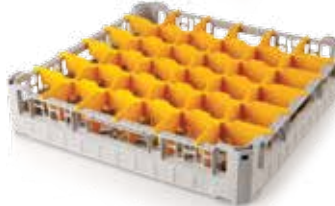

» Bardak Basketi 49 Bölmeli

49 Compartment Base

Kod	Ölçü (mm)
Code	Dim. (mm)
43003049	500x500x100



- » Yükseltici 9 Bölmeli
9 Compartment Extender

Kod Code	Ölçü (mm) Dim. (mm)
43004001	500x500x100



- » Yükseltici 16 Bölmeli
16 Compartment Extender

Kod Code	Ölçü (mm) Dim. (mm)
43004002	500x500x40



- » Yükseltici 25 Bölmeli
25 Compartment Extender

Kod Code	Ölçü (mm) Dim. (mm)
43004003	500x500x40



- » Yükseltici 36 Bölmeli
36 Compartment Extender

Kod Code	Ölçü (mm) Dim. (mm)
43004004	500x500x40



- » Yükseltici 49 Bölmeli
49 Compartment Extender

Kod Code	Ölçü (mm) Dim. (mm)
43004005	500x500x40



- » Yükseltici Açık Bölmesiz
Open Extender

Kod Code	Ölçü (mm) Dim. (mm)
43004006	500x500x40



- » Çatal Kaşık Basketi 8 Bölmeli Dik Tip
Cutlery Holder 8 Compartments

Kod Code	Ölçü (mm) Dim. (mm)	Renk Colour
43003004	450x250x200	Bej / Beige
43103004	450x250x200	Gri / Grey



430 431

- » Basket Taşıma Arabası Kolsuz
Dolly

Kod Code	Ölçü (mm) Dim. (mm)	Renk Colour
43003005	580x580x220	Siyah / Black
43103005	580x580x220	Mavi / Blue
43203005	580x580x220	Kahverengi / Brown
43303005	580x580x220	Kırmızı / Red



430 431 432 433

Elektrikli Sinek Öldürücüler / Electrical Insect Killers

- Gerilim/Voltage : 220 - 230 V / 50 Hz
- Güç/UV Tube : 2x20 W
- Tesir alanı/Effective Range : 35-40 m²
- Deşarj Gerilimi/Discharge Voltage : 5000 V
- Ağırlık/Weight : 9,5 Kg
- Ölçü/Dimensions : 70x21,5x39 cm



» Sinek Öldürme Cihazı
Electrical Insect Killer

Kod Code	Güç Power
67010001	2x20 W

- Gerilim/Voltage : 220 - 230 V / 50 Hz
- Güç/UV Tube : 2x40 W
- Tesir alanı/Effective Range : 55-60 m²
- Deşarj Gerilimi/Discharge Voltage : 5000 V
- Ağırlık/Weight : 9,5 Kg
- Ölçü/Dimensions : 70x21,5x39 cm



» Sinek Öldürme Cihazı
Electrical Insect Killer

Kod Code	Güç Power
67010002	2x40 W

- Gerilim/Voltage : 220 - 230 V / 50 Hz
- Güç/UV Tube : 2x40 W
- Tesir alanı/Effective Range:100-110 m²
- Deşarj Gerilimi/Discharge Voltage: 5000 V
- Ağırlık/Weight: 13 Kg
- Ölçü/Dimensions : 127x21,5x39 cm

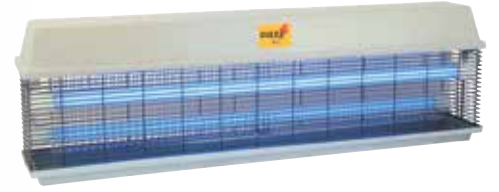

» Sinek Öldürme Cihazı
Electrical Insect Killer

Kod Code	Güç Power
67010003	2x40 W

292

- Gerilim/Voltage :220 - 230 V / 50 Hz
- Güç/UV Tube : 2x40 W (Kısa Ampül)
- Tesir alanı/Effective Range :50 m²
- Ölçü/Dim. : 70x50x25 cm



» Sinek Öldürme Cihazı Yapışkanlı
Electronic Insect Trap

Kod Code	Güç Power
67010004	2x20 W

- Gerilim/Voltage : 220 - 230 V / 50 Hz
- Güç/UV Tube :2x40 W (Uzun Ampül)
- Tesir alanı/Effective Range : 100 m²
- Ölçü/Dim. : 125x50x25 cm

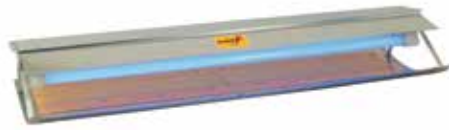

» Sinek Öldürme Cihazı Yapışkanlı
Electronic Insect Trap

Kod Code	Güç Power
67010006	2x20 W

- Gerilim : 220 - 230 V / 50 Hz
- Güç : 2x40 W (Kısa Ampül)
- Tesir alanı : 50 m²
- Ölçü/Dim. : 62,5x31x21 cm



» Sinek Öldürme Cihazı Yapışkanlı
Electronic Insect Trap

Kod Code	Güç Power
67010005	2x20 W



» Bulaşık Yıkama Duşu
Dish Washing

Kod Code	Model Model
41030008	Klasik Tezgaha Monte/ Classic Counter-Mounted
41130008	Ara Musluklu Tezgaha Monte/ Mid-tap Counter-Mounted
41030011	Klasik Duvara Monte/ Classic Wall-Mounted
41130011	Ara Musluklu Duvara Monte/ Mid-tapWall-Mounted

» Geri Toplamalı Bulaşık Yıkama Duşu
Dish Washing Wall-Mounted

Kod Code	Model Model
41030007	Klasik/ Classic
41030010	Ara Musluklu/ Mid-tap

» Eveye
Sink

Kod Code	Ölçü (cm) Dim. (cm)
30804425	40x40x25
30804525	40x50x25
30805525	50x50x25



» Tekerlekli Çöp Kovası
Rubbish Bin w/Wheels

Kod Code	Model Model	Øxh(cm) Øxh(cm)
35524040	Kapaklı	40x40
35524041	w/Wheel-w/o Lid	40x40
	Kapaklı	
	w/Wheel-w/Lid	

» Saksılık
Pot w/o Bottom and w/o Handles

Kod Code	Øxh(cm) Øxh(cm)	Lt Lt
35522400	24x28	12,5
35522800	28x28	17,2
35523200	32x32	26
35503600	36x36	36,6
35504000	40x40	50
35505000	50x50	100
35506000	60x55	155

» Rotil Ayak
Rotil Feet

Kod Code	Ölçü(cm) Dim.(cm)
46014055	40x55x115/181
46014040	40x40x93/151
46016060	Ø 60

Belgelerimiz

- TSE ÜRÜN KALİTE UYGUNLUK BELGESİ
- TSEK UYGUNLUK BELGESİ
- CE İŞARETİ DEKLARASYONU
- GOST-R RUSYA KALİTE BELGESİ
- ISO 9001:2008 KALİTE YÖNETİM SİSTEM BELGESİ
- ISO 22000:2005 GIDA GÜVENLİĞİ BELGESİ
- HACCP BELGESİ
- YERLİ MALİ BELGESİ



- Fiyatlarımıza KDV dahil değildir.
- Nakliye alıcı firmaya aittir.
- Sevkiyatlar için tercih ambarınızı lütfen belirtiniz.
- Siparişlerinizi faks ve e-mail ile bildiriniz.

Faks : 0 232 853 74 75
E-mail : pazarlama@kapp.com.tr

ALFABETİK İNDEKS

A	Açık Büfe Ekmek Sepetleri	193	El Tipi Blender	232/235	
	Açık Büfe Standları	172/174	Elektrikli Sinek Öldürücü	290	
	Açık Büfe Sunum Tepsileri	177/179	Et Arabası	280	
	Açık Büfe Üniteleri	162/167	Et Çatalları	118	
	Açık Büfe Yükselticiler	180/181	Et-Kemik Testeresi	250/251	
	Ahşap Sunum Tabakları	198/199	Evyeler	291	
	Alüminyum Baklava Tepsileri	108	F	Fırın Tepsileri	20/21
	Alüminyum Teflon Tavalar	26		French Press	218
	Aperatif Sunumluklar	203	G	Garson Çakısı	225
	Ayran&Şerbet Soğutucu	211		Gastronom Ekipmanları	43
B	Bakır Chafing Dish	129		Gastronom Kapaklar	40
	Bar Ekipmanları	226		Gıda Dilimleyiciler	242/247
	Basket Taşıma Arabası	289		Gitar	109
	Basketler	288		Gömme Chafing Dishler	151
	Bıçak Sterilizatörü	85	H	Helvane Kapaklar	10
	Bıçaklar	75/84		Helvane Tencereler	10
	Blender	264/266	I	İpinium Fırın Tepsileri	22
	Bulaşık Yıkama Duşları	291		Isıtıcı Lambalar	130
	Buz Kırıcı	226		Isıtıcı Plate	262
	Buz Kırıcı	268/269	İ	İçecek Kupası	218
	Buz Kovaları	222		İçecek Makineleri	214/215
	Buzlu İçecek Makinesi/Ice Slush	212		İçecek Mikser	266
C	Chafing Dish Ekipmanları	156		İndeksiyon Ekipmanları	147
	Chafing Dish Küvetleri	154		İndeksiyon Ocaklar	260/261
Ç	Çatal Kaşık Basketi	289		İndüksiyon Ocaklar	168/171
	Çay Otomatları	213	J	Japon Tornaları	54
	Çay/Süt Potları	218	K	Kaçarolalar	25
	Çelik Eldiven	85		Kanepe Sunumluklar	176
	Çelik Kızartma Örtüsü	16/17		Karbon Çelik Tavalar	27
	Çelik Saklama Kapları	53		Kaseler	205
	Çerezlikler	227		Kaset Taşıma Arabası	280
	Çırpma Telleri	71		Kaşık Standı	124
	Çift Renkli Duy Seti	104		Kaşıklar	118
	Çikolata Eritme Makinesi	103		Kayrak Sunum Tabakları	182/183
	Çikolata Kalıpları	97/98		Kayrak Sunum Tabakları	196/197
	Çorbalık	12		Kepçe Standı	124
	Çorbalık	153		Kepçeler	117
	Çöp Kovası	291		Kevgirler	117
D	Dekor Kaşık Seti	124		Kıyma Makinesi	259
	Delux Chafing Dishler	149/150		Klasik Chafing Dishler	152
	Dilimleyiciler	55		Kokteyl Shakerlar	225
	Dispenserler	157/159		Konserve Açacağı	58
	Dispenserler	216/217		Konveyörlü Fırın	257
	Dondurma Kaşıkları	124		Kuskus Tencere Seti	13
	Dondurma Makinesi	212		Küllükler	207
	Döküm Tavalar	29/31		Küllükler	229
	Döküm Tencereler	15		Küvetler	41/42
	Düdüklü Tencere	9	L	Lux Chafing Dish	131/136
E	Ekmek Kızartma Mak.	258	M	Makarna Pişirme Süzgeci	12
	Ekmek Sepetleri	206		Mandolin Kesme Ünit.	54
	El Aletleri	59/61		Masa Standı	224

Maşalar	122/123
Melamin Gast. Küvetler	45
Melamin Sunumluklar	184/188
Mikrodalga Fırın	256
Mini Sunumluklar	175
Modern Chafing Dish	138/139
N Narenciye Sıkacağı	267
Ö Ölçme Kapları	107
Ölçülü Kaplar	65
P Paslanmaz Çelik Kalıplar	99/100
Paslanmaz Çelik Tavalar	24
Pastane İndeksiyon Ocağı	102
Patates Küreği	124
PC Gastronom Küvetler	48/49
PC Kırılmaz Tepsi	114
PC Ölçülü Saklama Kap.	51
PC Sunum Tabakları	200
PC Sürahi	218
Peynir Rendeleyici	241
Pilav Ölçeği	124
Planet Mikser	248/249
Polietilen Kesim Levhaları	74
Polikarbonat Bardaklar	219
Portakal/Nar Sıkma	213
PP Saklama Kapları	52
Premium Chafing Dish	141/146
Punch Bowllar	225
Püre Makineleri	58
R Reçel & Baharat Set	202
Rendeler	66
Restaurant Ekipmanları	204
Rulet	101
S Sac Tavalar	28
Saksılık	291
Saplı Gast. Küvetler	38/39
SDX Boxlar	282
Sebze Doğrayıcı	56
Sebze Doğrayıcılar	236/240
Sebze Kurutucu	54
Sefer Tasları	273
Self Servisler	116
Seramik Tavalar	26
Servis Arabaları	277/279
Servis Set (İthal)	120
Servis Setleri	155
Sıcak Çikolata/ Sahlep Makinesi	211
Silikon Kalıplar	94/96
Silikon Kalıplar 40x60 cm	91/93
Silikon Servis Ekipmanları	121
Silindirik Kapaklar	13
Silindirik Tencereler	11

Silpat	96
Soft Cooker	254/255
Sos Dispenserleri	125
Sos Şişeleri	125
Sos/Şurup Dökücü	125
Sosluk	153
Spatulalar	72/73
Spatulalar	110/111
Spatulalar	119
Standart Gast. Küvetler	34/35
Standlar	108
Sunum Kaseleri	189/191
Süzgeçler	68/70
Süzgeçli Gast. Küvetler	36/37
Ş Şampanya Kova Standı	224
Şampanya&Şarap Kovaları	224
Şef Cimbızı	123
Şerbetlik	210
Şişe Soğutucular	222
Şişe Standı	224
T Tabak İstif Arabaları	280
Tartılar	64
Taşıma Arabaları	280/281
Taşıma Kovaları	272
Taşıma Tepsileri	273
Tel Raflar	283/285
Tepsiler	115/116
Tepsiler	228
Termo Tepsi	276
Termometreler	62/63
Termoslar	218
Thermoboxlar	275/276
Tirbüşon	225
Tuzluk&Karabiberlik Setleri	201
V Vakumlu Paket Makinesi	252
Y Yağlık&Sirkelikler	202
Yanmaz Eldiven	101
Yapışmaz Kalıplar	88/90
Yükselticiler	289

ALPHABETICAL INDEX

A	Abc Containers	61	Carbon Steel Non-stick Paella Pan	36	Cutlery Bin 4 Compartment	286
	Acrylic Sugar Caddy	226	Carbon Steel Non-stick Square Grill	36	Cutlery Rack	296
	Adjustable Dish Dolly	288	Carbon Steel Non-stick Wok Pan	36	Cutlery Stand	182
	Adjustable Mould	107	Carbon Steel Wok Pan	35	Cutting Board For Gn Pan	82
	Aluminum Non-stick Creppe Pan	34	Carrying Container	280	Cutting Board Pe	82
	Aluminum Non-stick Frypan	34	Carrying Tray	281	Cutting Board Rack	82
	Aluminum Non-stick Wok Pan	34	Cast Iron Pots	25	D Deco Spoon Set	132
	Aluminium Pizza Tray	28	Ceramic Coated Pan	29	Decorator	67
	Amuse Bouche Spoon	182	Chafing Dish Built-in	159	Decorator	68
	Amuse Bouche Spoon Stand	182	Chafing Dish Classic	160/161	Deep Casserole (Bistro)	14/17
	Appetizer Display	235	Chafing Dish Copper	137	Deep Casserole (Exclusive)	20
	Apple Corer	68	Chafing Dish Delux	156/159	Deep Saucepan (Exclusive)	21
	Apple Wedger	67	Chafing Dish Food Pan	162	Demontable Service Trolley	286
	Ashtray	215	Chafing Dish Food Pan Porcelain	162	Dish Washing	299
	Ashtray Stand	215	Chafing Dish Lux	139/144	Dispenser	224/225
B	Baguette Basket	201	Chafing Dish Modern	146/147	Dispenser Cereal	166
	Bain-marie Pot Calibrated	73	Chafing Dish Premium	149/154	Dispenser Coffee	165
	Baking Sheet Non-stick	97	Chalice Sweetener	234	Dispenser Ice Tea	165
	Baking Sheet Silicone	104	Champagne Bucket	232	Dispenser Juice	165
	Bamboo Base W/high Heat Magnet	35	Champagne/ice Bucket Stand	232	Display Basket	211
	Bar Spoon	234	Charcoal Tong	131	Display Cover	212
	Bar Strainer	234	Cheese Grater	249	Display Plate	162
	Beverage Blender	272/274	Cheese Knife	68	Display Stand	172/173
	Beverage Mixer	274	Cheese Slicer	68	Dolly	297
	Beverage Thermobox	284	Chef Tong	131	Dough Scrapper	81
	Blender	222	Chef's Tong	75	Dough Wheel	109
	Blender	240/243	Chinese Colander	77	DRAINER Plate	51
	Bo	115	Chocolate Moulds	105/106	E Egg Ring	74
	Bone Saw	258/259	Citrus Juicer	223	Egg Slicer	67
	Boston Shaker	233	Citrus Juicer	275	Egg Stand W/heater	182
	Bottle Cooler	230	Cleaver	92	Electrical Heating Unit	164
	Bottle Stand	232	Cocktail Shaker	233	Elevator	188/189
	Bouillon Strainer	77	Colander	76	Elevator Stand	152
	Bowl	197/198	Colander (Exclusive)	21	Enamel Coated Pan	29
	Bowl Hammered	213	Colander For Gn Pan	51	F Fish Bone Pincer	131
	Bread Basket	201	Colander For Saucepan (Exclusive)	21	Fish Scale Cleaner PE	76
	Bread Basket	214	Cold Plate Unit	174	Flacone	115
	Bread Basket Rattan	174	Compartment Base	296	Food Mill	66
	Bucket Calibrated	73	Compartment Extender	297	Food Pan Porcelain Round	50
	Burner Holder	164	Condiment Set	210	French Fries Shovel	132
	Butcher Gloves Chainmail	93	Conical Bowl Calibrated	73	French Fry Cutter	63
	Butter Curler	68	Conical Saute Pan	33	French Press	226
C	Cake Ring	107	Conical Snack Holder	211	Fruit Stand	182
	Cake Stand	116	Conical Strainer	77	Fruit Striper	68
	Can Opener	68	Convection Oven	265	Frypan (Bistro)	14/17
	Candle Holder	212	Conveyor Toaster	266	Funnel W/strainer	77
	Carbon Steel Blinis Pan	35	Cooler&dispenser	219	G Garlic Press	67
	Carbon Steel Frypan	35	Couscous Colander	22	Glass Mug	226
	Carbon Steel Non-stick Creppe Pan	36	Couscous Set W Lid	22	Glass Pc	227
	Carbon Steel Non-stick Frypan	36	Cream Whipper	113	Glass Rack	296
			Cutlery Bin	286	Glove	109

Gn 1/1 Angled Adaptor Plate	51	Mandoline	62	Pizza Warmer	270
Gn Appetizer Pan	49	Manuel Can Opener	66	Planet Mixer	256/257
Gn Food Pan Lid	48	Mayonnaise Bottle	133	Plate Cover	212
GN Food Pans	42	Mayonnaise Dispenser	133	Plate Rack Mobile	288
GN Food Pans Perforated	44	Measuring Cup	73	Plate Rack Table Top	242
GN Food Pans w/handle	46	Measuring Cup Pc	73	Plate/trays Rack	296
Gn Ice Cream Container	49	Measuring Cup Set	73	Plates PC	208
Gn Melamine Pans	57	Measuring Spoon Set	73	Pomegranate Dispenser	221
Gn Pan Adjustment Bar	51	Meat Carrying Dolly	288	Portable Food Container	281
Gn Pc Pans	56	Meat Fork	126	Potato Masher	75
Gn Porcelain Food Pan	50	Meat Hook	92	Poultry Shears	67
Granita&ice Slush Dispenser	220	Meat Tenderiser	92	Pourer	234
Grater	71	Melamine Bowl	192/193	Pouring Container	115
Grater	74	Melamine Display Plates	194/196	Pouring Container	133
Gravy Boat	212	Microwave Oven	264	Pp Storage Containers	60
Grid For Hot Dishes	51	Milk Can	165	Pressure Cooker	9/10
Grill Tong	131	Mini Display Pan	211	Pressure cooker lid	9/10
H Hamburger Press	66	Mini Melamine Displays	183	Punch Bowl	233
Honey Comb Stand	182	Mini Punch Bowl	230	R Revolving Cake Stand	116
Honey Spoon PE	75	Mini Tea Bag Holder	226	Rice Scoop	132
Hot Chocolate Dispenser	219	Miniature French Fries Basket	211	Roast Easy	27
Hot Plate Unit	174	Mixing Bowl Calibrated	73	Roasting Pan	28
I Ice Bucket	230	Mixing Glass	233	Roasting Pan Round	28
Ice Cream Cup	213	Mixing Spatula	75	Roller	114
Ice Cream Spoon	132	Monoblock Service Trolley	286	Rolling Pin	114
Ice Crusher	234	Mortar PE	76	Rubbish Bin	299
Ice Crushing Machine	276/277	Mould Non-stick	96/98	S S/S Pans	32
Ice Slush Dispenser	220	Moulds Silicone	99/104	Salad Spinner	62
Icing Tip Set	113	Mug	226	Salt & Pepper Set	209
Induction Cooker	176/179	Mustard Bottle	133	Sauce Bottle	133
Induction Cooker	268/269	Mustard Dispenser	133	Sauce Gun	74
Induction Heating	164	N Name Tag	164	Sauce Ladle	125
Infrared Lamp	168/169	Napkin Holder	212	Sauce Tureen	161
Ingredient Bin	288	Napkin/pipette Holder	234	Saucepan	33
Insect Killers Electrical	298	Non-stick Gn (Aluminium)	29	Saucepan (Bistro)	14/17
Isothermic Tray	284	Non-stick Gn (Stainless)	29	Sautepan	32
J Japanese Mandoline	62	Nut Cracker	67	Scale	72
Jar Set	210	○ Oil&vinegar Stand	210	Scissor	67
Jigger	234	○ Orange Juicer	221	Scoop	75
Jug PC	226	P Pans Cast Iron	37	Sdx Thermobox	290
Juice Cooler	218	Pans Ceramic Coated	34	Seed Remover Olive/cherry	67
Jumbo Stockpot (Bistro)	14/17	Pasta Colander 1/4 - Segment	22	Self Service	124
Jumbo Stockpot (Exclusive)	20	Pasta Colander Set	22	Self Service Pc	124
K Ketchup Bottle	133	Pastry Bag	112	Serving Set	128/132
Ketchup Dispencer	133	Pc Bar Container	234	Serving Spatula	127
Knife Sterilizer	93	Pc Square Food Storage Container	59	Serving Spoon	126
Knives	84/90	Peeler	68	Serving Trolley	285
L Ladle	125	Perforated Shelf	291	Shaker	76
Lid (Bistro)	14/17	Perforated Shelf W/4 Floor	292/293	Shallow Casserole (Bistro)	14/17
Lid Satin (Exclusive)	21	Pineapple Peeler	63	Shallow Casserole (Exclusive)	20
M Magnetic Board	93	Pizza Roulette	81	Shallow Saucepan (Exclusive)	21

Shallow Stewpan (Bistro)	14/17
Shallow Stewpan (Exclusive)	21
Sieve	76
Silicone Cover For Handle	36
Silicone seal	9/10
Silicone Utensils	129
Sink	299
Skimmer	125
Skimmer	78
Slate Display	190/191
Slicer	250/255
Soft Cooker	262/263
Soup Tureen	161
Spatula	80
Spatula Angular	80
Spatula Monoblock	127
Spatula Pastry	80
Spatula PE	75
Spatula Pizza	80
Spatula Wide	78
Speed Rail	74
Spoon	126
Spoon Rest	132
Square Ring	107
Stand	180/182
Stockpot (Exclusive)	20
Storing Shelf For Cutting Board	82
Sugar Bowl Pc	210
Swivel Peeler	68
T Tea Maker	221
Tea/milk Pot	226
Thermobox	284
Thermobox 600	283
Thermometer	70
Tickets Holder	75
Timer Digital	70
Toastbrot Non-stick	97
Tomato Slicer	63
Tongs	130
Torch	113
Tray Aluminium	116
Tray Cart	240/241
Tray Crystal Display	185
Tray Display	124
Tray PC Unbreakable	122
Tray Serving	123
Turning Slicer	62
U Utensils	68
Utility Rack	289
V Vacuum Packaging Machines	260
Vegetable Cutter	64

Vegetable Cutter	244/248
Vegetable Wedger	63
W Warmer Stand	155
Waste Bin	285
Water Jug	226
Whisk	79
Wide Shallow Pans	23
Wide Shallow Pot's Lid	23
Wide Shallow Pots	23
Wine Bucket	232
Wine Bucket Table Stand	232
Wire Grid	51
Wooden Base	25
Wooden Display Plates	206/207
Y Y-shaped Swivel Peeler	68

Cooking
Preparing
Pastry
Serving
Open Buffet
Table-Top
Beverage
Bar
Kitchen Appliances
Carrying
Dish Washing



+90 850 441 5277 (pbx)

Istanbul Showroom: Sultan Selim Cad. Turan Sk. No: 19
Kat: 4 34416 4. Levent / ISTANBUL - TURKEY
Phone: +90 0 212 264 76 70 - 80 Fax: +90 0 212 264 76 40

Izmir Factory: 29 Ekim Mah. Kuscu Cad. No: 11
Yazibasi, Torbali / Izmir - TURKEY
Tel: +90 0 232 853 74 74 (pbx) Fax: +90 0 232 853 74 75
www.kapp.com.tr - pazarlama@kapp.com.tr

