

CATALOGO E LISTINO   CATALOGUE & PRICE LIST  
CATALOGUE ET LISTE DE PRIX   KATALOG UND PREISLISTE





# forcar<sup>®</sup>

CARRELLI PLURISERVICE - MULTISERVICE TROLLEYS  
CHARIOTS MULTI-SERVICES - MEHRSERVICE WAGEN

2015/16

|  |                 |
|--|-----------------|
| Carrelli di servizio in legno, Mobili di servizio - Wodden service trolleys, Serving furniture<br>Chariots de service en bois, Meubles de service - Servicewagen aus Holz, Servicemöbel  | pag. <b>3</b>   |
| Carrelli di servizio inox - Stainless steel service trolleys - Chariots de service inox - Servicewagen aus Edelstahl   | pag. <b>41</b>  |
| Carrelli ed espositori refrigerati, Carrelli, Tavole, Distributori Termici, Carrelli termici bagnomaria<br>Refrigerated trolleys and display cases, Trolleys, Tables, Thermal distributors, Thermal double boiler trolleys<br>Chariots et présentoirs réfrigérés, Chariots, Tables, Distributeurs thermiques, Chariots thermiques bain-marie<br>Wagen und gekühlter Ausstellungswagen, Thermo, Wagen, Tische, Ausgabevorrichtungen, Thermowagen für wasserbäder  | pag. <b>57</b>  |
| Carrelli ed espositori refrigerati in legno, Espositore caldo bagnomaria con cupola, Bolliti e arrostiti<br>Refrigerated wooden trolleys and display cases, Bain-marie warmed display case with dome, Roast and boiled meat trolley<br>Chariots et présentoirs réfrigérés en bois, Présentoir chauffé bain-marie avec cloche, Chariot pour bouillis et rotis<br>Wagen und gekühlter Ausstellungswagen aus Holz, Warme wasserbadausstellung mit kuppel, Wagen für Kochfleisch und Braten  | pag. <b>69</b>  |
| Tavole calde da banco, Piani caldi inox, lampade a raggi infrarossi, Vettrine bar<br>Lunch counters, Stainless steel warming surfaces, With infrared lamps, Showcases for bar<br>Tables chauffées pour comptoir, Plateaux chauffés en inox, lampes à infrarouges, Vittrines pour bar<br>Heiztische, Heizplatten aus rostfreiem stahl, Mit infrarotlampen, Bar-warmvittrinen  | pag. <b>87</b>  |
| Carrelli portavassoi, Carrelli portateglie GN - Tray-holder trolley, GN pan trolley<br>Chariot porte-plateaux, Chariots portes-plaques GN - Tablettwagen, GN Auflaufformenwagen  | pag. <b>103</b> |
| Carrelli portapiatti, vassoi e teglie - Dish, tray and pan carts<br>Chariot porte-assiettes, plateaux et plaques - Geschirrwagen, Tablett und Auflaufformen Tellerwagen  | pag. <b>119</b> |
| Carrelli portabiancheria, pulizia, multiuso - Laundry, cleaning, multipurpose trolley<br>Chariots porte-linge, Nettoyage, Multi-usage - Wagen für Wäschereien, Reinigungsbetriebe, Mehrzweck   | pag. <b>133</b> |
| Carrelli portavalige e portabiti, Carrelli breakfast, Macchina pulisci-scarpe, Aste delimita corsie<br>Luggage and Clothing stands, Breakfast trolley, Shoeshine machine, Lane poles<br>Chariots porte-valises et porte-habits, Chariots Petit-déjeuner, Machine nettoyeuse de chaussures, Tige de délimitation de passage<br>Koffertwagen und Kleiderständerwagen, Frühstückswagen, Apparat zum Schuhe putzen, Bahnabgrenzungstangen  | pag. <b>145</b> |
| Pattumiere e portarifiuti - Garbage and dust bin - Boîtes à ordures et poubelles - Abfallbehälter  | pag. <b>161</b> |
| Chafing dishes gastronorm, Distributori per caffè, caffè caldo, bevande, cereali, Zuppiera elettrica<br>Chafing Dish, Distributors for coffee, hot coffee, beverages, cereals, Electric pan<br>Bain-marie, Distributeurs de café, café chaud, boissons, cereals, Récipient électrique<br>Chafing Dish, Distributoren für Kaffee, heißen Kaffee, Getränke, Getreide, Elektrische wanne  | pag. <b>167</b> |
| Bacinelle gastronorm e vaschette per gelato, Bacinelle gn in policarbonato, Accessori per cucina, Accessori per pizzeria, Bilancia elettronica<br>GN basins and ice cream drums, GN pans in polycarbonate, Kitchen accessories, Accessories for pizzeria, Electronic scale<br>Bacs Gastronorm et bacs à glace, Bacs GN en polycarbonate, Accessoires pour cuisines, Accessoires pour pizzeria, Balance électronique<br>Gastronorm Schüssel und Eisschalen, GN Polycarbonatbehälter, Kochzubehöre, Zubehör für Pizzerien, Elektronische Waage | pag. <b>173</b> |
| Ceppi, Copriceppo, Taglieri, Accessori per macelleria - Chopping Block, Chopping Block Cover, Chopping boards, Butchery accessories<br>Souche, Couvre Souche, Planches à hacher, Accessoires pour boucherie - Hackklotz, Hackklotzdecke, Hackbrette, Metzgereibetriebe   | pag. <b>185</b> |
| Sterilizzatori elettrici, Accessori antinfortunistici, Lavamani, Scaffalatura modulare, Elettroinsetticidi a lampade UV-A<br>Electric sterilizers, Safety accessories, Wash basins, Modular shelving, Ultraviolet ray bug lamp<br>Stérilisateurs électriques, Accessoires de protection, Lave-mains, Rayonnement modulaire, Insecticide électrique à lampes UV-A<br>Elektrische Sterilisatoren, Unfallschutz-Zubehör, Handwaschbecken, Bausteinregale, UV-A-Lampen-Insektenfänger  | pag. <b>199</b> |

*Carrelli di servizio in legno*   
*Carrelli gueridon*  
*Carrelli di servizio in legno massello*  
*Dolci, formaggi e antipasti*  
*Carrello portavini*  
*Carrelli flambè*  
*Accessori per carrelli legno e acciaio*  
*Mobili di servizio*





*Wodden service trolleys*   
*Gueridon trolleys*  
*Solid wood serving trolley*  
*Cake, cheese and hors d'oeuvres trolley*  
*Wine trolley*  
*Flambé trolley*  
*Accessories for wooden and steel trolley*  
*Serving furniture*

*Chariots de service en bois*   
*Chariots guéridons*  
*Chariots de service en bois massif*  
*Chariot pour dessert, fromages et hors d'oeuvres*  
*Chariot à vins*  
*Chariots pour plats flambés*  
*Accessoires pour chariot en bois et en acier*  
*Meubles de service*

*Servicewagen aus Holz*   
*Gueridon Wagen*  
*Servicewagen aus massivem Holz*  
*Kuchen, Käse und Vorspeisen Servierwagen*  
*Weinwagen*  
*Flambierwagen*  
*Zubehör für Holz und Stahlwagen*  
*Servicemöbel*

**Carrelli gueridon - Gueridon trolleys**  
**Chariots guéridons - Gueridon Wagen**



-  Struttura in acciaio inox tubolare alto spessore. 2 piani in nobilitato con bordo in gomma. 4 ruote multidirezionali Ø95.
-  Extra thick tubular steel structure with high quality wood veneer shelves. Four multidirectional wheels Ø95.
-  Structure en acier tubulaire de haute épaisseur avec deux rayons en simil-bois. Quatre roues pivotantes Ø95.
-  Gestell aus rostfreiem besonders starken Stahlrohr, 2 Platten aus veredeltem Holz. 4 leichtaufende Rollen, Ø95.





**CA 900**

**€ 175,00**

DIMENSIONI ESTERNE LxPxH cm  
 EXTERNAL DIMENSIONS LxPxH cm  
 DIMENSIONS EXTERIEURES LxPxH cm  
 AUBENABMESSUNGEN LxPxH cm

**65x50x78h**



-  Struttura portante in tubo di acciaio inox. Ripiani in nobilitato noce con bordo in gomma. Ruote pivotanti.
-  Stainless steel tubular structure. Shelves covered with plastic laminated brown. Swivelling wheels.
-  Châssis porteur en tube d'acier inox. Etagères en bois revêtues de laminé plastique marron. Roues pivotantes.
-  Ragende Struktur aus Niro-Stahl-Rohr. Borde mit Nussverteilung, mit Gummirand Drehräder.

**CA 901 2R**

**€ 235,00**

**CA 901 2RW**

**€ 235,00**

DIMENSIONI ESTERNE LxPxH cm  
 EXTERNAL DIMENSIONS LxPxH cm  
 DIMENSIONS EXTERIEURES LxPxH cm  
 AUBENABMESSUNGEN LxPxH cm

**70x50x78h**

## Carrelli gueridon - Gueridon trolleys Chariots guéridons - Gueridon Wagen



- 🇮🇹 Struttura portante in tubo di acciaio inox. Ripiani in nobilitato noce con bordo in gomma. Ruote pivotanti.
- 🇬🇧 Stainless steel tubular structure. Shelves covered with plastic laminated brown. Swivelling wheels.
- 🇫🇷 Châssis porteur en tube d'acier inox. Étagères en bois revêtues de laminé plastique marron. Roues pivotantes.
- 🇩🇪 Tagende Struktur aus Niro-Stahl-Rohr. Borde mit Nussverteilung, mit Gummirand Drehräder.

**CA 901** € 245,00

**CA 901W** € 245,00

DIMENSIONI ESTERNE LxPxH cm  
EXTERNAL DIMENSIONS LxPxH cm  
DIMENSIONS EXTERIEURES LxPxH cm  
AUBENABMESSUNGEN LxPxH cm

**70x50x78h**



- 🇮🇹 Montanti ottonati. Ripiani in nobilitato noce con bordo in gomma. Ruote pivotanti Ø95 ottonate.
- 🇬🇧 Brass painted structure. Shelves covered with plastic laminated brown. Brass covered swivelling wheels Ø95.
- 🇫🇷 Châssis porteur cuivée. Étagères en bois revêtues de laminé plastique marron. Roues pivotantes Ø95 cuivrées.
- 🇩🇪 Vermessingte Struktur. Borde mit Nußverteilung, mit Gummirand Drehräder Ø95, vermessingt.

**CO 902** € 290,00

DIMENSIONI ESTERNE LxPxH cm  
EXTERNAL DIMENSIONS LxPxH cm  
DIMENSIONS EXTERIEURES LxPxH cm  
AUBENABMESSUNGEN LxPxH cm

**70x50x78h**

## Carrelli gueridon - Gueridon trolleys Chariots guéridons - Gueridon Wagen



CL 903



CL 903W



CL 903B



CL 903N

- Montanti in legno massello. Ripiani in nobilitato noce con bordo in gomma. Ruote piroettanti Ø95 ottonate.
- Wood structure. Shelves covered with plastic laminated brown. Brass covered swivelling wheels Ø95.
- Châssis porteur en bois. Étagères en bois revêtues de laminé plastique marron. Roues pivotantes Ø95 cuivrées.
- Ständer aus Vollholz. Borde mit Nußverrgütung, mit Gummirand. Drehräder Ø95, vermessingt.

**CL 903** € 220,00

**CL 903W** € 220,00

**CL 903B** € 450,00

**CL 903N** € 450,00

DIMENSIONI ESTERNE LxPxH cm

EXTERNAL DIMENSIONS LxPxH cm

DIMENSIONS EXTERIEURES LxPxH cm

AUßENABMESSUNGEN LxPxH cm

**70x50x78h**



- Struttura in legno massello. Piani in multistrato di betulla tinto ciliegio. Ruote piroettanti Ø95 ottonate.
- Solid wood frame. Multilayer surfaces of birchwood cherry colour. Pivoting brass wheels Ø95.
- Structure en bois massif. Plateaux en feuilleté de bouleau couleur cerisier. Roues pivotantes Ø95 laitonées.
- Aufbau aus massivem Holz. Platten aus Vielschichtigem Birkeholz Farbe Kirschbaum. Drehbare Räder Ø95, vermessingt.

**LG 401** € 350,00

DIMENSIONI ESTERNE LxPxH cm

EXTERNAL DIMENSIONS LxPxH cm

DIMENSIONS EXTERIEURES LxPxH cm

AUßENABMESSUNGEN LxPxH cm

**70x50x78h**



- Struttura in legno massello. Piani in multistrato di betulla. Ruote piroettanti Ø95.
- Solid wood frame. Multilayer surfaces of birchwood. Pivoting wheels Ø95.
- Structure en bois massif. Plateaux en feuilleté de bouleau. Roues pivotantes Ø95.
- Aufbau aus massivem Holz. Platten aus Vielschichtigem Birkeholz. Drehbare Räder Ø95.

**CLE** € 408,00

DIMENSIONI ESTERNE LxPxH cm

EXTERNAL DIMENSIONS LxPxH cm

DIMENSIONS EXTERIEURES LxPxH cm

AUßENABMESSUNGEN LxPxH cm

**90x45x77h**

### Optionals

Su richiesta verniciati con colori RAL

Available on request painted in RAL colours

Disponibles sur demande vernis dans les couleurs RAL

Auf Anfrage lieferbar lackiert in RAL Farben

**€ 508,00**



## Carrelli flambè - Flambé trolley Chariots pour plats flambés - Flambierwagen

Struttura portante in legno multistrato di betulla tinto noce monocorpo con rivestimento in legno massello castagno. Piano di servizio ribaltante. 2 cassetti. Vano porta bombola da kg 2. Maniglia direzionale e portabottiglie ottonata. Piano di cottura in acciaio inox. Ruote multidirezionali.

Multilayer bichwood walnut colour monobloc side frames covered with solid chestnut-wood. Overturnable surface. 2 drawers. 2 kg gas cylinder space. Brass covered bottle-holder and handle. Stainless steel cooking-range. Multidirectional wheels.

Chassis monobloc en bois feuilleté de bouleau couleur noyer de châtaignier massif surface de service rabattante. 2 tiroirs. Coffre porte-bouteille de 2 kg. Poigné directionnelle et porte-bouteille cuivrée. Cusinière en acier inoxydable. Roues pivotantes.

Traggestell aus Vielschichtem Birkeholz Nussbaum Farbe von einem Block mit massiver Kastanienholzverkleidung. Kippbare Servierplatte - 2 Schubladen. Raum für 2 kg. Gasflasche. Vermessingter Richtungsgriff und Flaschehalter, Kochfläche aus Edelstahl. Leichtlaufende Rollen.



|   |                         |   |                         |  |                         |
|---|-------------------------|---|-------------------------|--|-------------------------|
| <b>CL 2750</b>  | <b>€ 1.360,00</b>       | <b>CL 2751</b>  | <b>€ 1.205,00</b>       | <b>CL 2752</b>   | <b>€ 1.410,00</b>       |
| <b>CL 2750W</b>   | <b>€ 1.360,00</b>       | <b>CL 2751W</b>   | <b>€ 1.205,00</b>       | <b>CL 2752W</b>  | <b>€ 1.410,00</b>       |
| DIMENSIONI ESTERNE LxPxH cm<br>EXTERNAL DIMENSIONS LxPxH cm<br>DIMENSIONS EXTERIEURES LxPxH cm<br>AUBENABMESSUNGEN LxPxH cm | <b>107/145x 58x91 h</b> | DIMENSIONI ESTERNE LxPxH cm<br>EXTERNAL DIMENSIONS LxPxH cm<br>DIMENSIONS EXTERIEURES LxPxH cm<br>AUBENABMESSUNGEN LxPxH cm | <b>107/145x 58x91 h</b> | DIMENSIONI ESTERNE LxPxH cm<br>EXTERNAL DIMENSIONS LxPxH cm<br>DIMENSIONS EXTERIEURES LxPxH cm<br>AUBENABMESSUNGEN LxPxH cm              | <b>107/145x 58x91 h</b> |
| 1 Piastra. 2 Fuochi<br>1 cooking range. 2 Fires<br>1 cusinière. 2 brûleurs<br>1 Kochfläche. 2 Kochstellen                   |                         | 1 Piastra a 1 Fuoco<br>1 cooking range. 1 Fire<br>1 cusinière. 1 brûleur<br>1 Kochfläche. 1 Kochstelle                      |                         | 2 Piastre a 1 Fuoco separate<br>2 cooking ranges with 1 fire each<br>2 cusinières avec 1 brûleur<br>2 Kochflächen mit 1 Kochstelle jeder |                         |

### Optionals

|            |   |                 |
|------------|---|-----------------|
| <b>AB2</b> | Bombola gas 2 Kg. (vuota) - 2 Kg gas cylinder (empty)<br>Bouteille à gaz de 2 Kg (vide) - 2 Kg Gasflasche (leere)                         | <b>€ 55,00</b>  |
| <b>C</b>   | N. 4 ruote con cuffia ottonata - 4 wheels with brass painted covers<br>4 roues avec couverture cuivrée - 4 Räder mit Vermessingter Kappen | <b>€ 130,00</b> |

## Carrelli flambè - Flambé trolley

### Chariots pour plats flambés - Flambierwagen

🇮🇹 Mobile in legno nobilitato noce con piano di servizio ribaltabile, cassetto, maniglia portabottiglie in acciaio ottonato. Ruote ottonate Ø 100. Piano di cottura in acciaio inox con bruciatore regolabile.

🇬🇧 Wooden unit veneered in walnut with swivelling top. Drawer, bottle-holder handle in brass-plated steel. Brass-plated wheels diam. 100. Cooking hob in stainless steel with adjustable burner.

🇫🇷 Mouble contre-plaqué en noyer avec plan de service escamotable. Tiroir. Poignée du porte-bouteilles en acier laitoné. Roulettes laitonées Ø 100. Plan de cuisson en acier inox avec brûleur réglable.

🇩🇪 Möbel aus Holz mit Nußvergütung, mit kippbarer Ablagefläche. Fach. Flaschenhalter-Griff aus vermessingtem Stahl. Vermessingte Rollen Ø 100. Kochfläche aus Niro-Stahl mit einstellbarem Brenner.



|   |                        |   |                        |   |                        |
|---|------------------------|---|------------------------|---|------------------------|
| <b>CF 1200</b>  | <b>€ 905,00</b>        | <b>CF 1201</b>  | <b>€ 1.060,00</b>      | <b>CF 1202</b>  | <b>€ 1.120,00</b>      |
| <b>CF 1200W WENGÉ</b>   | <b>€ 905,00</b>        | <b>CF 1201W WENGÉ</b>   | <b>€ 1.060,00</b>      | <b>CF 1202W WENGÉ</b>   | <b>€ 1.120,00</b>      |
| DIMENSIONI ESTERNE LxPxH cm<br>EXTERNAL DIMENSIONS LxPxH cm<br>DIMENSIONS EXTERIEURES LxPxH cm<br>AUBENABMESSUNGEN LxPxH cm | <b>105/143x58x85 h</b> | DIMENSIONI ESTERNE LxPxH cm<br>EXTERNAL DIMENSIONS LxPxH cm<br>DIMENSIONS EXTERIEURES LxPxH cm<br>AUBENABMESSUNGEN LxPxH cm | <b>105/143x58x85 h</b> | DIMENSIONI ESTERNE LxPxH cm<br>EXTERNAL DIMENSIONS LxPxH cm<br>DIMENSIONS EXTERIEURES LxPxH cm<br>AUBENABMESSUNGEN LxPxH cm             | <b>105/143x58x85 h</b> |
| 1 Piastra a 1 Fuoco<br>1 cooking range. 1 Fire<br>1 cusinière. 1 brûleur<br>1 Kochfläche. 1 Kochstelle                      |                        | 1 Piastra. 2 Fuochi<br>1 cooking range. 2 Fires<br>1 cusinière. 2. brûleurs<br>1 Kochfläche. 2 Kochstellen                  |                        | 2 piastre a 1 fuoco separate<br>2 cooking ranges with 1 fire each<br>2 Cusinières avec 1 brûleur<br>2 Kochfläche mit 1 Kochstelle jeder |                        |

### Optionals

**AB3** Bombola gas 3 Kg. (vuota) - 3 Kg gas cylinder (empty) **€ 60,00**  
Bouteille à gaz de 3 Kg (vide) - 3 Kg Gasflasche (leere)



## Carrelli di servizio in legno - *Wodden service trolleys* Chariots de service en bois - *Servicewagen aus Holz*



CLP 2002



CLP 2002W



CLP 2002B



CLP 2002N

🇮🇹 Struttura in legno massello. Piani in multistrato di betulla tinto noce. Ruote piroettanti Ø 95 cromate.

🇬🇧 Solid wood frame. Multilayer surfaces of birchwood walnut colour. Pivoting chromium plated wheels Ø 95.

🇫🇷 Structure en bois massif. Plateaux en feuilleté de bouleau couleur noyer. Roues pivotantes Ø 95 chromées.

🇩🇪 Aufbau aus massivem Holz. Platten aus Vielschichtigem nussbaum Farbe Kirschbaum. Drehbare Räder Ø 95, verchromt.

**CLP 2002** € 440,00

**CLP 2002W** € 440,00

**CLP 2002B** € 540,00

**CLP 2002N** € 540,00

DIMENSIONI ESTERNE LxPxH cm **110x55x82h**  
EXTERNAL DIMENSIONS LxPxH cm **2 piani / 2 Shelves**  
DIMENSIONS EXTERIEURES LxPxH cm **2 Rayons / 2 Platten**  
AUBENABMESSUNGEN LxPxH cm



🇮🇹 Struttura in legno massello. Piani in multistrato di betulla tinto noce. Ruote piroettanti Ø 95 cromate.

🇬🇧 Solid wood frame. Multilayer surfaces of birchwood walnut colour. Pivoting chromium plated wheels Ø 95.

🇫🇷 Structure en bois massif. Plateaux en feuilleté de bouleau couleur noyer. Roues pivotantes Ø 95 chromées.

🇩🇪 Aufbau aus massivem Holz. Platten aus Vielschichtigem nussbaum Farbe Kirschbaum. Drehbare Räder Ø 95, verchromt.

**CLP 2002 L40** € 380,00

**CLP 2002 L40W** € 380,00

DIMENSIONI ESTERNE LxPxH cm **110x40x82h**  
EXTERNAL DIMENSIONS LxPxH cm **2 piani / 2 Shelves**  
DIMENSIONS EXTERIEURES LxPxH cm **2 Rayons / 2 Platten**  
AUBENABMESSUNGEN LxPxH cm

**Carrelli di servizio in legno - Wodden service trolleys**  
**Chariots de service en bois - Servicewagen aus Holz**



CLP 2003



CLP 2003W



CLP 2003B



CLP 2003N

🇮🇹 Struttura in legno massello. Piani in multistrato di betulla tinto noce. Ruote piroettanti Ø 95 cromate.

🇬🇧 Solid wood frame. Multilayer surfaces of birchwood walnut colour. Pivoting chromium plated wheels Ø 95.

🇫🇷 Structure en bois massif. Plateaux en feuilleté de bouleau couleur noyer. Roues pivotantes Ø 95 chromées.

🇩🇪 Aufbau aus massivem Holz. Platten aus Vielschichtigem nussbaum Farbe Kirschbaum. Drehbare Räder Ø 95, verchromt.

**CLP 2003 € 585,00**

**CLP 2003W € 585,00**

**CLP 2003B € 720,00**

**CLP 2003N € 720,00**

DIMENSIONI ESTERNE LxPxH cm **110x55x89h**  
 EXTERNAL DIMENSIONS LxPxH cm **3 piani / 3 Shelves**  
 DIMENSIONS EXTERIEURES LxPxH cm **3 Rayons / 3 Platten**  
 AUBENABMESSUNGEN LxPxH cm



🇮🇹 Struttura in legno massello. Piani in multistrato di betulla tinto noce. Ruote piroettanti Ø 95 cromate.

🇬🇧 Solid wood frame. Multilayer surfaces of birchwood walnut colour. Pivoting chromium plated wheels Ø 95.

🇫🇷 Structure en bois massif. Plateaux en feuilleté de bouleau couleur noyer. Roues pivotantes Ø 95 chromées.

🇩🇪 Aufbau aus massivem Holz. Platten aus Vielschichtigem nussbaum Farbe Kirschbaum. Drehbare Räder Ø 95, verchromt.

**CLP 2003 L40 € 490,00**





**CLP 2003 L40W € 490,00**

DIMENSIONI ESTERNE LxPxH cm **110x40x89h**  
 EXTERNAL DIMENSIONS LxPxH cm **3 piani / 3 Shelves**  
 DIMENSIONS EXTERIEURES LxPxH cm **3 Rayons / 3 Platten**  
 AUBENABMESSUNGEN LxPxH cm

## Carrelli di servizio in legno - *Wodden service trolleys* Chariots de service en bois - *Servicewagen aus Holz*



CLC 2012

-  Carrello per dolci, formaggi e antipasti in legno cupola in PLX semicircolare con coperchi rientranti.
-  Cake, cheese and hors d'oeuvres wooden trolley semicircular Plexiglas cover with re-entring lids.
-  Charoit en bois pour dessert fromages et hors d'oeuvres. Clochesemicerculaire en plexiglas avec couvercles rentrants.
-  Servierwagen aus holz fur Dessert, Kaese und vorspeisen. Halbrunde Kuppel aus Plexiglass mit Zuruecktretenden Dekkeln.

**CLC 2012** € 660,00

**CLC 2012W** € 660,00

**CLC 2012B** € 760,00

**CLC 2012N** € 760,00

DIMENSIONI ESTERNE LxPxH cm **110x55x107h**  
EXTERNAL DIMENSIONS LxPxH cm *2 piani / 2 Shelves*  
DIMENSIONS EXTERIEURES LxPxH cm *2 Rayons / 2 Platten*  
AUBENABMESSUNGEN LxPxH cm



CLC 2012W



CLC 2012B



CLC 2012N

**Carrelli di servizio in legno - Wodden service trolleys**  
**Chariots de service en bois - Servicewagen aus Holz**



CLC 2013

- 🇮🇹 Carrello per dolci, formaggi e antipasti in legno cupola in PLX semicircolare con coperchi rientranti.
- 🇬🇧 Cake, cheese and hors d'oeuvres wooden trolley semicircular Plexiglas cover with re-entring lids.
- 🇫🇷 Charoit en bois pour dessert fromages et hors d'oeuvres. Clochesemicerculaire en plexigals avec couvercles rentrants.
- 🇩🇪 Servierwagen aus holz fur Dessert, Kaese und vorspeisen. Halbrunde Kuppel aus Plexiglass mit Zuruecktretenden Dekkeln.

|                  |                 |
|------------------|-----------------|
| <b>CLC 2013</b>  | <b>€ 810,00</b> |
| <b>CLC 2013W</b> | <b>€ 810,00</b> |
| <b>CLC 2013B</b> | <b>€ 960,00</b> |
| <b>CLC 2013N</b> | <b>€ 960,00</b> |

|                                 |                      |
|---------------------------------|----------------------|
| DIMENSIONI ESTERNE LxPxH cm     | <b>110x55x114h</b>   |
| EXTERNAL DIMENSIONS LxPxH cm    | 3 piani / 3 Shelves  |
| DIMENSIONS EXTERIEURES LxPxH cm | 3 Rayons / 3 Platten |
| AUßENABMESSUNGEN LxPxH cm       |                      |



CLC 2013W



CLC 2013B



CLC 2013N

**Optionals**

|             |   |                |
|-------------|---|----------------|
| <b>A100</b> | Pianetto reggiplatto a scomparsa - Rollaway dish holder surface<br>Petit plateau porte assiette coulissant - Kleine verschwindbare Fellerhalterplatte | <b>€ 50,00</b> |
| <b>A200</b> | Cassetto portaposate a 3 scomparti - 3 buckets cutlery tray<br>Panier à couverts à 3 compartiments - Besteckkasten mit 3 Fächer                       | <b>€ 80,00</b> |





## Carrelli di servizio in legno - *Wodden service trolleys* Chariots de service en bois - *Servicewagen aus Holz*



CL 70



CL 70W

-  Struttura in legno massello. Piani in multistrato di betulla tinto noce. Ruote piroettanti Ø 95 cromate.
-  Solid wood frame. Multilayer surfaces of birchwood walnut colour. Pivoting chromium plated wheels Ø 95.
-  Structure en bois massif. Plateaux en feuilleté de bouleau couleur noyer. Roues pivotantes Ø 95 chromées.
-  Aufbau aus massivem Holz. Platten aus Vielschichtem nussbaum Farbe Kirschbaum. Drehbare Räder Ø 95, verchromt.

**CL 70** € 420,00

**CL 70W** € 420,00

DIMENSIONI ESTERNE LxPxH cm  
EXTERNAL DIMENSIONS LxPxH cm  
DIMENSIONS EXTERIEURES LxPxH cm  
AUBENABMESSUNGEN LxPxH cm

**70x50x85h**

**CL 90** € 455,00

**CL 90W** € 455,00

DIMENSIONI ESTERNE LxPxH cm  
EXTERNAL DIMENSIONS LxPxH cm  
DIMENSIONS EXTERIEURES LxPxH cm  
AUBENABMESSUNGEN LxPxH cm

**90x50x85h**

 Accessori optional vedi pag. 30/31 -  Accessories on demand see page 30/31

 Accessoires sur demande voir page 30/31 -  Zubehör auf Anfrage : sehen Sie Seite 30/31



A 1250 - A 1260 - A 1250W - A 1260W



A 1290 - A 1290W



A 1299 - A 1298 - A 1299W - A 1298W

## Carrelli di servizio in legno - Wodden service trolleys Chariots de service en bois - Servicewagen aus Holz

-  Pianetto reggi piatto a scomparsa / 
  Rollaway dish holder surface  
 Petit plateau porte assiette coulissant / 
  Kleine verschwindbare Fellerhalterplatte



### A 100 optional

€ 50,00

Accessori optional per mod.  
 Accessories on deman for mod.  
 Accessoires sur demande pour mod.  
 Zubehöre auf Anfrage für Mod.

**CL 90 - CL 90W**  
**CL 2001 - CL2001W**  
**CL2151 - CL2151W**







### A 100W optional

€ 50,00

Accessori optional per mod.  
 Accessories on deman for mod.  
 Accessoires sur demande pour mod.  
 Zubehöre auf Anfrage für Mod.

**CL 70 - CL70W - CL2000 - CL2000W**  
**CL2150 - CL2150W - CL 90 - CL 90W**  
**CL 2001 - CL2001W - CL2151 - CL2151W**

-  Cassetto portaposate a 2 scomparti / 
  2 buckets cutlery tray  
 Panier à couverts à 2 compartiments / 
  Besteckkasten mit 2 Fächer



### A 150 optional

€ 70,00

Accessori optional per mod.  
 Accessories on deman for mod.  
 Accessoires sur demande pour mod.  
 Zubehöre auf Anfrage für Mod.

**CL 70 - CL70W - CL2000 - CL2000W**  
**CL2150 - CL2150W - CL 90 - CL 90W**  
**CL 2001 - CL2001W - CL2151 - CL2151W**







### A 150W optional

€ 70,00

Accessori optional per mod.  
 Accessories on deman for mod.  
 Accessoires sur demande pour mod.  
 Zubehöre auf Anfrage für Mod.

**CL 70 - CL70W - CL2000 - CL2000W**  
**CL2150 - CL2150W - CL 90 - CL 90W**  
**CL 2001 - CL2001W - CL2151 - CL2151W**

-  Cassetto portaposate a 3 scomparti / 
  3 buckets cutlery tray  
 Panier à couverts à 3 compartiments / 
  Besteckkasten mit 3 Fächer



### A 200 optional

€ 80,00

Accessori optional per mod.  
 Accessories on deman for mod.  
 Accessoires sur demande pour mod.  
 Zubehöre auf Anfrage für Mod.

**CL 90 - CL 90W**  
**CL 2001 - CL2001W**  
**CL2151 - CL2151W**



### A 200W optional

€ 80,00

Accessori optional per mod.  
 Accessories on deman for mod.  
 Accessoires sur demande pour mod.  
 Zubehöre auf Anfrage für Mod.

**CL 70 - CL70W - CL2000 - CL2000W**  
**CL2150 - CL2150W - CL 90 - CL 90W**  
**CL 2001 - CL2001W - CL2151 - CL2151W**

## Carrelli di servizio in legno - *Wodden service trolleys* Chariots de service en bois - *Servicewagen aus Holz*



CL 2000



CL 2000W

-  Carrello servizio legno. Struttura in legno multistrato di betulla tinto noce con spalliere portanti monoblocco. Piani in laminato antiacido con cornice perimetrale in legno massello. 4 ruote multidirezionali.
-  Multilayer birchwood walnut colour monobloc sides frames. Laminated acid-proof shelves with surrounding solid wood frame. 4 Multidirectional wheels.
-  Chariot service en bois massif. Structure en bois feuilleté de bouleau couleur noyer avec chassis portant monobloc, rayons en laminé antiacide avec corniche périmétrale en bois massif. 4 roues pivotantes.
-  Servicewagen aus Holz. Gestell aus Vielschichtigem Birkeholz Nussbaum Farbe mit Tragseiten aus einem Block. Platten aus säurefestem Laminat mit Massivholzrahmen. 4 leichtlaufende Rollen.

**CL 2000** € 550,00

**CL 2000W** € 550,00

DIMENSIONI ESTERNE LxPxH cm **86x55x85h**  
EXTERNAL DIMENSIONS LxPxH cm *2 piani / 2 Shelves*  
DIMENSIONS EXTERIEURES LxPxH cm *2 Rayons / 2 Platten*  
AUBENABMESSUNGEN LxPxH cm

**CL 2001** € 570,00

**CL 2001W** € 570,00

DIMENSIONI ESTERNE LxPxH cm **106x55x85h**  
EXTERNAL DIMENSIONS LxPxH cm *2 piani / 2 Shelves*  
DIMENSIONS EXTERIEURES LxPxH cm *2 Rayons / 2 Platten*  
AUBENABMESSUNGEN LxPxH cm

 Accessori optional vedi pag. 30/31 -  Accessories on demand see page 30/31

 Accessoires sur demande voir page 30/31 -  Zubehör auf Anfrage : sehen Sie Seite 30/31



A 1270 - A 1280  
A 1270W - A 1280W



A 1250 - A 1260  
A 1250W - A 1260W



A 1290 - A 1290W



A 1299 - A 1298  
A 1299W - A 1298W

**Carrelli di servizio in legno - Wodden service trolleys**  
**Chariots de service en bois - Servicewagen aus Holz**



CL 2150



CL 2150W

- 🇮🇹 Carrello servizio legno. Struttura in legno multistrato di betulla tinto noce con spalliere portanti monoblocco. Piani in laminato antiacido con cornice perimetrale in legno massello. 4 ruote multidirezionali.
- 🇬🇧 Multilayer birchwood walnut colour monobloc sides frames. Laminated acid-proof shelves with surrounding solid wood frame. 4 Multidirectional wheels.
- 🇫🇷 Chariot service en bois massif. Structure en bois feuilleté de bouleau couleur noyer avec chassis portant monobloc, rayons en laminé antiacide avec corniche périmétrale en bois massif. 4 roues pivotantes.
- 🇩🇪 Servierwagen aus Holz. Gestell aus Vielschichtigem Birkeholz Nussbaum Farbe mit Tragseiten aus einem Block. Platten aus säurefestem Laminat mit Massivholzrahmen. 4 leichtlaufende Rollen.

**CL 2150** € 640,00

**CL 2150W** € 640,00

DIMENSIONI ESTERNE LxPxH cm **86x55x85h**  
 EXTERNAL DIMENSIONS LxPxH cm *3 piani / 3 Shelves*  
 DIMENSIONS EXTERIEURES LxPxH cm *3 Rayons / 3 Platten*  
 AUBENABMESSUNGEN LxPxH cm

**CL 2151** € 670,00

**CL 2151W** € 670,00

DIMENSIONI ESTERNE LxPxH cm **106x55x85h**  
 EXTERNAL DIMENSIONS LxPxH cm *3 piani / 3 Shelves*  
 DIMENSIONS EXTERIEURES LxPxH cm *3 Rayons / 3 Platten*  
 AUBENABMESSUNGEN LxPxH cm

🇮🇹 Accessori optional vedi pag. 30/31 - 🇬🇧 Accessories on demand see page 30/31

🇫🇷 Accessoires sur demande voir page 30/31 - 🇩🇪 Zubehöre auf Anfrage : sehen Sie Seite 30/31



A 1270 - A 1280  
A 1270W - A 1280W



A 1250 - A 1260  
A 1250W - A 1260W



A 1290 - A 1290W





A 1299 - A 1298  
A 1299W - A 1298W



## Carrelli di servizio in legno - *Wodden service trolleys* Chariots de service en bois - *Servicewagen aus Holz*

 Struttura, piani e contenitori in legno massello e controplaccato tinteleggiato ciliegio. Maniglia direzionale. Poggiapiatti scorrevole a scomparsa. Ruote pivotanti Ø mm 100.

 Framework in polished cherry-wood with carved uprights; cherry veneered shelves. Pushing handle. Sliding out dishholder. Full swivelling castors Ø mms 100.

 Châssis en cerisier, étagères et montants en bois cerisier. Poignée de direction. Porte-assiettes coulissant. Roulettes pivotantes Ø mm 100.

 Rohstruktur aus Kirschbaumholz. Abstellflächen und Behälter aus massivholz mit Kirschbaumholz furnierblatt. handgriff. Verschiebbare Tellerabstellplatte. Lenkräder Ø 100 mm.



**LP 412**

**€ 650,00**

DIMENSIONI ESTERNE LxPxH cm  
EXTERNAL DIMENSIONS LxPxH cm  
DIMENSIONS EXTERIEURES LxPxH cm  
AUBENABMESSUNGEN LxPxH cm

**81x56x81h**

2 piani / 2 Shelves  
2 Rayons / 2 Platten

**LP 413**

**€ 680,00**

DIMENSIONI ESTERNE LxPxH cm  
EXTERNAL DIMENSIONS LxPxH cm  
DIMENSIONS EXTERIEURES LxPxH cm  
AUBENABMESSUNGEN LxPxH cm

**113x56x81h**

2 piani / 2 Shelves  
2 Rayons / 2 Platten



**LP 411**

**€ 780,00**

DIMENSIONI ESTERNE LxPxH cm  
EXTERNAL DIMENSIONS LxPxH cm  
DIMENSIONS EXTERIEURES LxPxH cm  
AUBENABMESSUNGEN LxPxH cm

**81x56x81h**

3 piani / 3 Shelves  
3 Rayons / 3 Platten

**LP 414**

**€ 830,00**

DIMENSIONI ESTERNE LxPxH cm  
EXTERNAL DIMENSIONS LxPxH cm  
DIMENSIONS EXTERIEURES LxPxH cm  
AUBENABMESSUNGEN LxPxH cm

**113x56x81h**

3 piani / 3 Shelves  
3 Rayons / 3 Platten

### Optionals

**C**

N. 4 ruote con cuffia - 4 wheels with covers - 4 roues avec couverture - 4 Räder mit Kappen

**€ 130,00**

**ATTENZIONE!** Le foto sono con OPTIONAL (ruote cuffiate) / **ATTENTION!** Photos shown on the catalogue are with OPTIONAL (wheels with hoods)  
**ATTENTION!** Les photos sur le catalogue sont avec OPTIONAL (roues avec casques) / **ACHTUNG!** Die Photo auf dem Katalog sind EXTRAUSSTATTUNG (Rollen mit Kappen)

## Carrelli di servizio in legno massello - Solid wood serving trolley Chariots de service en bois massif - Servicewagen aus massivem Holz

 Struttura in legno massello. Piani in multistrato di betulla tinto wengè. Ruote piroettanti Ø 100 cromate.

 Solid wood frame. Multilayer surfaces of birchwood walnut colour. Pivoting chromium plated wheels Ø 100.

 Structure en bois massif. Plateaux en feuilleté de bouleau couleur noyer. Roues pivotantes Ø 100 chromées.

 Aufbau aus massivem Holz. Platten aus Vielschichtem nussbaum Farbe Kirschbaum. Drehbare Räder Ø 100, verchromt.



### LP 800W

€ 640,00

DIMENSIONI ESTERNE LxPxH cm  
EXTERNAL DIMENSIONS LxPxH cm  
DIMENSIONS EXTERIEURES LxPxH cm  
AUBENABMESSUNGEN LxPxH cm

**81x55x82h**  
2 piani / 2 Shelves  
2 Rayons / 2 Platten

### LP 1000W

€ 690,00

DIMENSIONI ESTERNE LxPxH cm  
EXTERNAL DIMENSIONS LxPxH cm  
DIMENSIONS EXTERIEURES LxPxH cm  
AUBENABMESSUNGEN LxPxH cm

**115x55x82h**  
2 piani / 2 Shelves  
2 Rayons / 2 Platten



### LP 850W

€ 770,00

DIMENSIONI ESTERNE LxPxH cm  
EXTERNAL DIMENSIONS LxPxH cm  
DIMENSIONS EXTERIEURES LxPxH cm  
AUBENABMESSUNGEN LxPxH cm

**81x55x82h**  
3 piani / 3 Shelves  
3 Rayons / 3 Platten

### LP 1050W

€ 825,00

DIMENSIONI ESTERNE LxPxH cm  
EXTERNAL DIMENSIONS LxPxH cm  
DIMENSIONS EXTERIEURES LxPxH cm  
AUBENABMESSUNGEN LxPxH cm

**115x55x82h**  
3 piani / 3 Shelves  
3 Rayons / 3 Platten

**ATTENZIONE!** Le foto sono con OPTIONAL (ruote cuffiate) / **ATTENTION!** Photos shown on the catalogue are with OPTIONAL (wheels with hoods)  
**ATTENTION!** Les photos sur le catalogue sont avec OPTIONAL (roues avec casques) / **ACHTUNG!** Die Photo auf dem Katalog sind EXTRAUSSTATTUNG (Rollen mit Kapfen)

**Carrelli di servizio in legno - Wooden service trolleys**  
**Chariots de service en bois - Servicewagen aus Holz**



**LP 800**

**€ 640,00**

DIMENSIONI ESTERNE LxPxH cm  
 EXTERNAL DIMENSIONS LxPxH cm  
 DIMENSIONS EXTERIEURES LxPxH cm  
 AUBENABMESSUNGEN LxPxH cm

**81x55x82h**  
 2 piani / 2 Shelves  
 2 Rayons / 2 Platten

**LP 1000**

**€ 690,00**

DIMENSIONI ESTERNE LxPxH cm  
 EXTERNAL DIMENSIONS LxPxH cm  
 DIMENSIONS EXTERIEURES LxPxH cm  
 AUBENABMESSUNGEN LxPxH cm

**115x55x82h**  
 2 piani / 2 Shelves  
 2 Rayons / 2 Platten



**LP 850**

**€ 770,00**

DIMENSIONI ESTERNE LxPxH cm  
 EXTERNAL DIMENSIONS LxPxH cm  
 DIMENSIONS EXTERIEURES LxPxH cm  
 AUBENABMESSUNGEN LxPxH cm

**81x55x82h**  
 3 piani / 3 Shelves  
 3 Rayons / 3 Platten

**LP 1050**

**€ 825,00**

DIMENSIONI ESTERNE LxPxH cm  
 EXTERNAL DIMENSIONS LxPxH cm  
 DIMENSIONS EXTERIEURES LxPxH cm  
 AUBENABMESSUNGEN LxPxH cm

**115x55x82h**  
 3 piani / 3 Shelves  
 3 Rayons / 3 Platten

**ATTENZIONE!** Le foto sono con OPTIONAL (ruote cuffiate) / **ATTENTION!** Photos shown on the catalogue are with OPTIONAL (wheels with hoods)  
**ATTENTION!** Les photos sur le catalogue sont avec OPTIONAL (roues avec casques) / **ACHTUNG!** Die Photo auf dem Katalog sind EXTRAUSSTATTUNG (Rollen mit Kappen)

## Dolci, formaggi e antipasti - Cake, cheese and hors d'oeuvres trolley

### Chariot pour dessert, fromages et hors d'oeuvres - Kuchen, Käse und Vorspeisen Servierwagen

 Carrello servizio legno. Struttura in legno multistrato di betulla tinto noce con spalliere portanti monoblocco. Piani in laminato antiacido con cornice perimetrale in legno massello. 4 ruote multidirezionali.

 Multilayer birchwood walnut colour monobloc sides frames. Laminated acid-proof shelves with surrounding solid wood frame. 4 Multidirectional wheels.



 Chariot service en bois massif. Structure en bois feuilleté de bouleau couleur noyer avec châssis portant monobloc, rayons en laminé antiacide avec corniche périmétrale en bois massif. 4 roues pivotantes.

 Servierwagen aus Holz. Gestell aus Vielschichtem Birkeholz Nussbaum Farbe mit Tragseiten aus einem Block. Platten aus säurefestem Laminat mit Massivholzrahmen. 4 leichtlaufende Rollen.

**CL 2590**

**€ 725,00**

**CL 2590W**

**€ 725,00**

DIMENSIONI ESTERNE LxPxH cm  
EXTERNAL DIMENSIONS LxPxH cm  
DIMENSIONS EXTERIEURES LxPxH cm  
AUBENABMESSUNGEN LxPxH cm

**86x55x85h**

*Due piani e cassetta portaposate a 6 scomparti  
Two shelves, 6 compartment cutlery box  
Deux étagères et casie portecouverts à 6 compartiments  
Zwei Abstellflächen. Besteckkasten mit 6 Fächern*

**CL 2591**

**€ 750,00**

**CL 2591W**

**€ 750,00**

DIMENSIONI ESTERNE LxPxH cm  
EXTERNAL DIMENSIONS LxPxH cm  
DIMENSIONS EXTERIEURES LxPxH cm  
AUBENABMESSUNGEN LxPxH cm

**106x55x85h**

*Due piani e cassetta portaposate a 8 scomparti  
Two shelves, 8 compartment cutlery box  
Deux étagères et casie portecouverts à 8 compartiments  
Zwei Abstellflächen. Besteckkasten mit 8 Fächern*

## **Dolci, formaggi e antipasti - Cake, cheese and hors d'oeuvres trolley** **Chariot pour dessert, fromages et hors d'oeuvres - Kuchen, Käse und Vorspeisen Servierwagen**

 Struttura, piani e contenitori in legno massello e controplaccato tinteggiato ciliegio. Maniglia direzionale. Poggiapiatti scorrevole a scomparsa. Ruote pivotanti Ø mm 100. Portata complessiva Kg 50.

 Framework in polished cherry-wood with carved uprights; cherry veneered shelves. Pushing handle. Sliding out dishholder. Full swivelling castors Ø mms 100. Total capacity 50 Kg.

 Châssis en cerisier, étagères et montants en bois contreplaqué cerisier. Poigné de direction. Porte-assiettes coulissant. Roulettes pivotantes Ø mm 100. Portée totale 50 Kg.

 Rohstruktur aus Kirschbaumholz. Abstellflächen und Behälter aus massivholz mit Kirschbaumholz furnierblatt. Handgriff. Verschiebbare Tellerabstellplatte. Lenkräder Ø 100 mm. Tragfähigkeit 50 Kg.



### **LPP 415**

**€ 830,00**

DIMENSIONI ESTERNE LxPxH cm  
EXTERNAL DIMENSIONS LxPxH cm  
DIMENSIONS EXTERIEURES LxPxH cm  
AUBENABMESSUNGEN LxPxH cm

**81x56x81h**

*Due piani e cassetta portaposate a 6 scomparti  
Two shelves, 6 compartment cutlery box  
Deux étagères et casie portecouverts à 6 compartiments  
Zwei Abstellflächen. Besteckkasten mit 6 Fächern*

### **LPP 416**

**€ 880,00**

DIMENSIONI ESTERNE LxPxH cm  
EXTERNAL DIMENSIONS LxPxH cm  
DIMENSIONS EXTERIEURES LxPxH cm  
AUBENABMESSUNGEN LxPxH cm

**113x56x81h**

*Due piani e cassetta portaposate a 7 scomparti  
Two shelves, 7 compartment cutlery box  
Deux étagères et casie portecouverts à 7 compartiments  
Zwei Abstellflächen. Besteckkasten mit 7 Fächern*

### **Optionals**

**C**

N. 4 ruote con cuffia - 4 wheels with covers - 4 roues avec couverture - 4 Räder mit Kappen

**€ 130,00**

**ATTENZIONE!** Le foto sono con OPTIONAL (ruote cuffiate) / **ATTENTION!** Photos shown on the catalogue are with OPTIONAL (wheels with hoods)  
**ATTENTION!** Les photos sur le catalogue sont avec OPTIONAL (roues avec casques) / **ACHTUNG!** Die Photo auf dem Katalog sind EXTRAUSSTATTUNG (Rollen mit Kappen)

## Dolci, formaggi e antipasti - Cake, cheese and hors d'oeuvres trolley

### Chariot pour dessert, fromages et hors d'oeuvres - Kuchen, Käse und Vorspeisen Servierwagen

🇮🇹 Struttura acciaio inox. Piano in nobilitato con cornice perimetrale in acciaio inox. Ruote multidirezionali. Paracolpi in gomma. Portata complessiva Kg 80.

🇬🇧 Extra thick squared tubular structure. Two high quality wood veneer shelves with surrounding steel frame. Four multidirectional wheels. Rubber buffer. Total capacity 80 Kg.

🇫🇷 Structure en acier tubulaire carré de haute épaisseur avec deux rayons en similbois et corniche périmétrale en acier. Quatre roues pivotantes. Butoir en gomme. Portée totale 80 Kg.

🇩🇪 Struktur aus viereckigen sehr starkem Röhrr Stahl. Zwei Flächen aus verbessertem Holz mit umfassungsrahmen Ausstahl. Vier Multirichträder. Gummipuffer. Tragfähigkeit 80 Kg.



**CA 1180**

**€ 460,00**

**CA 1180W**

**€ 460,00**

DIMENSIONI ESTERNE LxPxH cm  
EXTERNAL DIMENSIONS LxPxH cm  
DIMENSIONS EXTERIEURES LxPxH cm  
AUBENABMESSUNGEN LxPxH cm

**85x57x97h**

*Due piani e cassetta portaposate a 6 scomparti  
Two shelves, 6 compartment cutlery box  
Deux étagères et casie portecouverts à 6 compartiments  
Zwei Abstellflächen. Besteckkastem mit 6 Fächern*



**CA 1181**

**€ 490,00**

**CA 1181W**

**€ 490,00**

DIMENSIONI ESTERNE LxPxH cm  
EXTERNAL DIMENSIONS LxPxH cm  
DIMENSIONS EXTERIEURES LxPxH cm  
AUBENABMESSUNGEN LxPxH cm

**105x57x97h**

*Due piani e cassetta portaposate a 8 scomparti  
Two shelves, 8 compartment cutlery box  
Deux étagères et casie portecouverts à 8 compartiments  
Zwei Abstellflächen. Besteckkastem mit 8 Fächern*

## **Dolci, formaggi e antipasti - Cake, cheese and hors d'oeuvres trolley** **Chariot pour dessert, fromages et hors d'oeuvres - Kuchen, Käse und Vorspeisen Servierwagen**

 Carrello per dolci, formaggi e antipasti (REGGIPIATTO E CASSETTO PORTAPOSATE OPTIONAL). Il carrello in foto è con accessori A 100 portapiatti A 200 cassetto portaposate.

 Cake, cheese and hors d'oeuvres trolley (PLATE SUPPORT AND CUTLERY-HOLDER ARE OPTIONAL). The trolley pictured includes accessories A100 plate holder and A 200 cutlery tray.



 Chariot pour hors d'oeuvres, dessert et fromages (PORTE-COUVERTS ET PORTE-ASSIETTE SONT OPTIONAL). Le chariot illustré dans la photo est doté des accessoires A 100 porte-assiettes et A200 tiroir à couverts.

 Servierwagen für Desserts, Käse und Vorspeisen (TELLERHALTER UND BESTECKKASTEN SIND AUF ANFRAGE). Der Wagen auf dem Photo ist mit Zubehör A100, Tellerhalter, und A200, Besteckkasten.



**CL 2350** € 750,00

**CL 2350W** € 750,00

DIMENSIONI ESTERNE LxPxH cm  
EXTERNAL DIMENSIONS LxPxH cm  
DIMENSIONS EXTERIEURES LxPxH cm  
AUBENABMESSUNGEN LxPxH cm **86x55x95h**

**CL 2351** € 820,00

**CL 2351W** € 820,00

DIMENSIONI ESTERNE LxPxH cm  
EXTERNAL DIMENSIONS LxPxH cm  
DIMENSIONS EXTERIEURES LxPxH cm  
AUBENABMESSUNGEN LxPxH cm **106x55x95h**

 Coperchio in plx trasparente h mm150 montato su pistoni frenanti.

 Cakes and cheese trolleys. Dome type plx cover (h mm150) mounted on braking arms.

 Chariots à pâtisserie et à fromages. Cloche en plx (h mm 150) avec bras freinants.

 Chariots à pâtisserie et à fromages. Cloche en plx (h mm 150) avec bras freinants.

**LDF 430** € 860,00

**LDF 431** € 985,00

DIMENSIONI ESTERNE LxPxH cm  
EXTERNAL DIMENSIONS LxPxH cm  
DIMENSIONS EXTERIEURES LxPxH cm  
AUBENABMESSUNGEN LxPxH cm **81x56x95h**  
2 piani / 2 Shelves  
2 Rayons / 2 Platten

**LDF 432** € 910,00

**LDF 433** € 1.045,00

DIMENSIONI ESTERNE LxPxH cm  
EXTERNAL DIMENSIONS LxPxH cm  
DIMENSIONS EXTERIEURES LxPxH cm  
AUBENABMESSUNGEN LxPxH cm **113x56x95h**  
3 piani / 3 Shelves  
3 Rayons / 3 Platten

**ATTENZIONE!** Le foto sono con OPTIONAL (ruote cuffiate) / **ATTENTION!** Photos shown on the catalogue are with OPTIONAL (wheels with hoods)  
**ATTENTION!** Les photos sur le catalogue sont avec OPTIONAL (roues avec casques) / **ACHTUNG!** Die Photo auf dem Katalog sind EXTRAUSSTATTUNG (Rollen mit Kappen)

## Dolci, formaggi e antipasti - Cake, cheese and hors d'oeuvres trolley

### Chariot pour dessert, fromages et hors d'oeuvres - Kuchen, Käse und Vorspeisen Servierwagen

 Cupola in plx semicircolare con coperchi rientranti. Il carrello in foto è con accessori A 100 porta piatti e A 200 cassetto portaposate (optional).

 Semicircular plexiglas dome with re-entering covers. The trolley pictured includes accessories A100 plate holder and A200 cutlery tray (optional).



 Cloche en plexiglas semi-circulaire à couvercles rentrants. Le chariot illustré sur la photo est doté des accessoires A100 porte-assiettes et A200 tiroir à couverts (optional).

 Halbrunde Kuppel aus Plexiglas mit zurücktretenden Deckeln. Der Wagen auf dem Photo ist mit Zubehör A100, Tellerhalter, und A200, Besteckkasten (extra ausstattung).



**CL 2255**

**€ 740,00**

**CL 2255W**

**€ 740,00**

DIMENSIONI ESTERNE LxPxH cm  
EXTERNAL DIMENSIONS LxPxH cm  
DIMENSIONS EXTERIEURES LxPxH cm  
AUBENABMESSUNGEN LxPxH cm

**86x55x110h**

**CL 2260**

**€ 770,00**

**CL 2260W**

**€ 770,00**

DIMENSIONI ESTERNE LxPxH cm  
EXTERNAL DIMENSIONS LxPxH cm  
DIMENSIONS EXTERIEURES LxPxH cm  
AUBENABMESSUNGEN LxPxH cm

**106x55x110h**

### Optionals

**A100** Pianetto reggiplatto a scomparsa - Rollaway dish holder surface  
Petit plateau porte assiette coulissant - Kleine verschwindbare Fellerhalterplatte **€ 50,00**

**A200** Cassetto portaposate a 3 scomparti - 3 buckets cutlery tray - Panier à couverts à 3 compartiments - Besteckkasten mit 3 Fächer **€ 80,00**

**A210** Piano intermedio per CL2255 - CL2350 **€ 90,00**

**A220** Piano intermedio per CCL2260 - CL2351 **€ 80,00**

**C** N. 4 ruote con cuffia - 4 wheels with covers - 4 roues avec couverture - 4 Räder mit Kappen **€ 130,00**

**ATTENZIONE!** Le foto sono con OPTIONAL (ruote cuffiate) / **ATTENTION!** Photos shown on the catalogue are with OPTIONAL (wheels with hoods)  
**ATTENTION!** Les photos sur le catalogue sont avec OPTIONAL (roues avec casques) / **ACHTUNG!** Die Photo auf dem Katalog sind EXTRAUSSTATTUNG (Rollen mit Kappen)



## **Dolci, formaggi e antipasti - Cake, cheese and hors d'oeuvres trolley** **Chariot pour dessert, fromages et hors d'oeuvres - Kuchen, Käse und Vorspeisen Servierwagen**

 Carrello servizio legno. Struttura in legno multistrato di betulla tinto wenge con spalliere portanti monoblocco. Piani in laminato antiacido con cornice perimetrale in legno massello. 4 ruote multidirezionali. Cupola plx.

 Wooden service trolley. Multilayer birchwood wenge colour monobloc sides frames. Laminated acid-proof shelves with surrounding solid wood frame. Multidirectional wheels. Plexiglass cover.

 Chariot service en bois. Structure en bois feuilleté de bouleau couleur wenge avec chassiss portant monobloc, rayons en laminé antiacide avec corniche périmétrale en bois massif et roues pivotantes. Couvercle en plexiglass.

 Servierwagen aus Holz. Vielschichtigem Birkeholzgestell wenge-Farbe mit Tragseiten aus einem Block. Platten aus säurefestem Laminat mit Massivholzrahmen, 4 leichtlaufende Rollen. Plexiglasdeckel.



### **LPC 800W**

**€ 820,00**

DIMENSIONI ESTERNE LxPxH cm  
EXTERNAL DIMENSIONS LxPxH cm  
DIMENSIONS EXTERIEURES LxPxH cm  
AUBENABMESSUNGEN LxPxH cm

**81x55x108**  
2 piani / 2 Shelves  
2 Rayons / 2 Platten

### **LPC1000W**

**€ 890,00**

DIMENSIONI ESTERNE LxPxH cm  
EXTERNAL DIMENSIONS LxPxH cm  
DIMENSIONS EXTERIEURES LxPxH cm  
AUBENABMESSUNGEN LxPxH cm

**115x55x108**  
2 piani / 2 Shelves  
2 Rayons / 2 Platten



### **LPC 850W**

**€ 935,00**

DIMENSIONI ESTERNE LxPxH cm  
EXTERNAL DIMENSIONS LxPxH cm  
DIMENSIONS EXTERIEURES LxPxH cm  
AUBENABMESSUNGEN LxPxH cm

**81x55x108**  
3 piani / 3 Shelves  
3 Rayons / 3 Platten

### **LPC 1050W**

**€ 1.030,00**

DIMENSIONI ESTERNE LxPxH cm  
EXTERNAL DIMENSIONS LxPxH cm  
DIMENSIONS EXTERIEURES LxPxH cm  
AUBENABMESSUNGEN LxPxH cm

**115x55x108**  
3 piani / 3 Shelves  
3 Rayons / 3 Platten

**ATTENZIONE!** Le foto sono con OPTIONAL (ruote cuffiate) / **ATTENTION!** Photos shown on the catalogue are with OPTIONAL (wheels with hoods)  
**ATTENTION!** Les photos sur le catalogue sont avec OPTIONAL (roues avec casques) / **ACHTUNG!** Die Photo auf dem Katalog sind EXTRAUSSTATTUNG (Rollen mit Kappen)

## Dolci, formaggi e antipasti - Cake, cheese and hors d'oeuvres trolley

### Chariot pour dessert, fromages et hors d'oeuvres - Kuchen, Käse und Vorspeisen Servierwagen

 Carrello servizio legno. Struttura in legno multistrato di betulla tinto noce con spalliere portanti monocolpo. Piani in laminato antiacido con cornice perimetrale in legno massello. 4 ruote multidirezionali. Cupola plex.

 Wooden service trolley. Multilayer birchwood walnut colour monobloc sides frames. Laminated acid-proof shelves with surrounding solid wood frame. Multidirectional wheels. Plexiglass cover.

 Chariot service en bois. Structure en bois feuilleté de bouleau couleur noyer avec chassis portant monobloc, rayons en laminé antiacide avec corniche périmétrale en bois massif et roues pivotantes. Couverture en plexiglass.

 Servierwagen aus Holz. Vielschichtigem Birkeholzgestell Nussbaum Farbe mit Tragseiten aus einen Block. Platten aus säurefestem Laminat mit Massivholzrahmen, 4 leichtlaufende Rollen. Deckel aus plexiglas.



#### LPC 800

€ 820,00

DIMENSIONI ESTERNE LxPxH cm  
EXTERNAL DIMENSIONS LxPxH cm  
DIMENSIONS EXTERIEURES LxPxH cm  
AUBENABMESSUNGEN LxPxH cm

**81x55x108**  
2 piani / 2 Shelves  
2 Rayons / 2 Platten



#### LPC1000

€ 890,00

DIMENSIONI ESTERNE LxPxH cm  
EXTERNAL DIMENSIONS LxPxH cm  
DIMENSIONS EXTERIEURES LxPxH cm  
AUBENABMESSUNGEN LxPxH cm

**115x55x108**  
2 piani / 2 Shelves  
2 Rayons / 2 Platten

#### LPC 850

€ 935,00

DIMENSIONI ESTERNE LxPxH cm  
EXTERNAL DIMENSIONS LxPxH cm  
DIMENSIONS EXTERIEURES LxPxH cm  
AUBENABMESSUNGEN LxPxH cm

**81x55x108**  
3 piani / 3 Shelves  
3 Rayons / 3 Platten

#### LPC 1050

€ 1.030,00

DIMENSIONI ESTERNE LxPxH cm  
EXTERNAL DIMENSIONS LxPxH cm  
DIMENSIONS EXTERIEURES LxPxH cm  
AUBENABMESSUNGEN LxPxH cm

**115x55x108**  
3 piani / 3 Shelves  
3 Rayons / 3 Platten

**ATTENZIONE!** Le foto sono con OPTIONAL (ruote cuffiate) / **ATTENTION!** Photos shown on the catalogue are with OPTIONAL (wheels with hoods)  
**ATTENTION!** Les photos sur le catalogue sont avec OPTIONAL (roues avec casques) / **ACHTUNG!** Die Photo auf dem Katalog sind EXTRAUSSTATTUNG (Rollen mit Kappen)

**Dolci, formaggi e antipasti - Cake, cheese and hors d'oeuvres trolley**  
**Chariot pour dessert, fromages et hors d'oeuvres - Kuchen, Käse und Vorspeisen Servierwagen**



**LDF 436**

**€ 900,00**

DIMENSIONI ESTERNE LxPxH cm  
 EXTERNAL DIMENSIONS LxPxH cm  
 DIMENSIONS EXTERIEURES LxPxH cm  
 AUBENABMESSUNGEN LxPxH cm

**113x56x105h**  
 2 piani / 2 Shelves  
 2 Rayons / 2 Platten

**LDF 437**

**€ 1.030,00**

DIMENSIONI ESTERNE LxPxH cm  
 EXTERNAL DIMENSIONS LxPxH cm  
 DIMENSIONS EXTERIEURES LxPxH cm  
 AUBENABMESSUNGEN LxPxH cm

**113x56x105h**  
 3 piani / 3 Shelves  
 3 Rayons / 3 Platten

🇮🇹 LDF 434/LDF 435 coperchio a due aperture con piano intermedio.

🇬🇧 LDF 434/435: in these models the showcase is provided with an auxiliary shelf and its cover can be raised from both sides.

🇫🇷 LDF 434/435: ces chariots ont le couvercle avec étagère mitoyenne et ouverture double.

🇩🇪 LDF 343/435: Dechel mit Abstellfläche in der Mitte und Zwei-seitiger Oeffnung.



**LDF 434**

**€ 1.070,00**

DIMENSIONI ESTERNE LxPxH cm  
 EXTERNAL DIMENSIONS LxPxH cm  
 DIMENSIONS EXTERIEURES LxPxH cm  
 AUBENABMESSUNGEN LxPxH cm

**113x56x120h**  
 2 piani / 2 Shelves  
 2 Rayons / 2 Platten

**LDF 435**

**€ 1.200,00**



DIMENSIONI ESTERNE LxPxH cm  
 EXTERNAL DIMENSIONS LxPxH cm  
 DIMENSIONS EXTERIEURES LxPxH cm  
 AUBENABMESSUNGEN LxPxH cm

**113x56x120h**  
 3 piani / 3 Shelves  
 3 Rayons / 3 Platten

**ATTENZIONE!** Le foto sono con OPTIONAL (ruote cuffiate) / **ATTENTION!** Photos shown on the catalogue are with OPTIONAL (wheels with hoods)  
**ATTENTION!** Les photos sur le catalogue sont avec OPTIONAL (roues avec casques) / **ACHTUNG!** Die Photo auf dem Katalog sind EXTRAUSSTATTUNG (Rollen mit Kappen)

## Dolci, formaggi e antipasti - Cake, cheese and hors d'oeuvres trolley

### Chariot pour dessert, fromages et hors d'oeuvres - Kuchen, Käse und Vorspeisen Servierwagen

-  Coperchio a due aperture con piano intermedio.
-  In these models the showcase is provided with an auxiliary shelf and its cover can be raised from both sides.

-  Ces chariots ont le couvercle avec étagère mitoyenne et ouverture double.

-  Dechel mit Abstellfläche in der Mitte und Zweiseitiger Oeffnung.



#### LPC 1100

€ 1.060,00

DIMENSIONI ESTERNE LxPxH cm  
EXTERNAL DIMENSIONS LxPxH cm  
DIMENSIONS EXTERIEURES LxPxH cm  
AUBENABMESSUNGEN LxPxH cm

**81x56x120**  
2 piani / 2 Shelves  
2 Rayons / 2 Platten

#### LPC1150

€ 1.180,00

DIMENSIONI ESTERNE LxPxH cm  
EXTERNAL DIMENSIONS LxPxH cm  
DIMENSIONS EXTERIEURES LxPxH cm  
AUBENABMESSUNGEN LxPxH cm

**116x56x120**  
3 piani / 3 Shelves  
3 Rayons / 3 Platten



#### LPC 1100 W

€ 1.060,00

DIMENSIONI ESTERNE LxPxH cm  
EXTERNAL DIMENSIONS LxPxH cm  
DIMENSIONS EXTERIEURES LxPxH cm  
AUBENABMESSUNGEN LxPxH cm

**81x56x120**  
2 piani / 2 Shelves  
2 Rayons / 2 Platten

#### LPC 1150 W

€ 1.180,00





DIMENSIONI ESTERNE LxPxH cm  
EXTERNAL DIMENSIONS LxPxH cm  
DIMENSIONS EXTERIEURES LxPxH cm  
AUBENABMESSUNGEN LxPxH cm

**116x56x120**  
3 piani / 3 Shelves  
3 Rayons / 3 Platten

**ATTENZIONE!** Le foto sono con OPTIONAL (ruote cuffiate) / **ATTENTION!** Photos shown on the catalogue are with OPTIONAL (wheels with hoods)  
**ATTENTION!** Les photos sur le catalogue sont avec OPTIONAL (roues avec casques) / **ACHTUNG!** Die Photo auf dem Katalog sind EXTRAUSSTATTUNG (Rollen mit Kappen)

## Carrello portavini - Wine trolley Chariot à vins - Weinwagen



-  **Carrello Espositore vini. Doppio.** Struttura in legno.
-  **Double wine rack trolley.** Solid wood structure.
-  **Chariot pour exposition de vins. Double.** Espositore de vins. Structure en bois massif.
-  **Doppelweinauslage.** Gestell aus massivem Holz.

**CL 2550** € 910,00

DIMENSIONI ESTERNE LxPxH cm  
EXTERNAL DIMENSIONS LxPxH cm  
DIMENSIONS EXTERIEURES LxPxH cm  
AUBENABMESSUNGEN LxPxH cm





**86x55x100h**

**CL 2551** € 980,00

DIMENSIONI ESTERNE LxPxH cm  
EXTERNAL DIMENSIONS LxPxH cm  
DIMENSIONS EXTERIEURES LxPxH cm  
AUBENABMESSUNGEN LxPxH cm

**106x55x100h**



-  **Cantinetta** Espositore vini. Struttura in legno.
-  **Wine cellar** Wine rack. Solid wood structure.
-  **Petite cave** Espositore de vins. Structure en bois massif.
-  **Weinregal** Weinauslage. Gestell aus massivem Holz.

**CL 2580** € 600,00

DIMENSIONI ESTERNE LxPxH cm  
EXTERNAL DIMENSIONS LxPxH cm  
DIMENSIONS EXTERIEURES LxPxH cm  
AUBENABMESSUNGEN LxPxH cm

**106x55x95h**

**ATTENZIONE!** Le foto sono con OPTIONAL (ruote cuffiate)  
**ATTENTION!** Photos shown on the catalogue are with OPTIONAL (wheels with hoods)  
**ATTENTION!** Les photos sur le catalogue sont avec OPTIONAL (roues avec casques)  
**ACHTUNG!** Die Photo auf dem Katalog sind EXTRAUSSTATTUNG (Rollen mit Kappen)

## Accessori per carrelli legno e acciaio - Accessories for wooden and steel trolley Accessoires pour chariot en bois et en acier - Zubehör für Holz und Stahlwagen

 Espositore vini. Struttura in legno.

 Wine rack. Solid wood structure.



FOR MODELS:  
CL2000W - CL2001W - CL2150W - CL2151W - CL2590W - CL2591W - CL90W

**A 1250** € 190,00

DIMENSIONI ESTERNE LxPxH cm - EXTERNAL DIMENSIONS LxPxH cm  
DIMENSIONS EXTERIEURES LxPxH cm - AUßENABMESSUNGEN LxPxH cm **68x46x19h**

**A 1260** € 210,00

DIMENSIONI ESTERNE LxPxH cm - EXTERNAL DIMENSIONS LxPxH cm  
DIMENSIONS EXTERIEURES LxPxH cm - AUßENABMESSUNGEN LxPxH cm **88x46x19h**

 Espositeur de vins. Structure en bois massif.

 Weinauslage. Gestell aus massivem Holz.



FOR MODELS:  
CL2000W - CL2001W - CL2150W - CL2151W - CL2590W - CL2591W - CL90W

**A 1250W** € 190,00

DIMENSIONI ESTERNE LxPxH cm - EXTERNAL DIMENSIONS LxPxH cm  
DIMENSIONS EXTERIEURES LxPxH cm - AUßENABMESSUNGEN LxPxH cm **68x46x19h**

**A 1260W** € 210,00

DIMENSIONI ESTERNE LxPxH cm - EXTERNAL DIMENSIONS LxPxH cm  
DIMENSIONS EXTERIEURES LxPxH cm - AUßENABMESSUNGEN LxPxH cm **88x46x19h**

 Espositore liquori. Struttura in legno. Ringhiere in acciaio inox.

 Liqueur rack with solid wooden structure. Small stainless steel bottle-guards.



FOR MODELS: CL2000W - CL2001W - CL2150W - CL2151W - CL2590W - CL2591W

**A 1270** € 200,00

DIMENSIONI ESTERNE LxPxH cm - EXTERNAL DIMENSIONS LxPxH cm  
DIMENSIONS EXTERIEURES LxPxH cm - AUßENABMESSUNGEN LxPxH cm **68x46x37h**

**A 1280** € 220,00

DIMENSIONI ESTERNE LxPxH cm - EXTERNAL DIMENSIONS LxPxH cm  
DIMENSIONS EXTERIEURES LxPxH cm - AUßENABMESSUNGEN LxPxH cm **88x46x37h**

 Espositeur de liqueurs avec structure en bois massif. Gardebouteilles en acier inox.

 Spirituosenauslage Massivholzgestell mit Flaschenschutz aus Edelstahl.



FOR MODELS: CL2000W - CL2001W - CL2150W - CL2151W - CL2590W - CL2591W

**A 1270W** € 200,00

DIMENSIONI ESTERNE LxPxH cm - EXTERNAL DIMENSIONS LxPxH cm  
DIMENSIONS EXTERIEURES LxPxH cm - AUßENABMESSUNGEN LxPxH cm **68x46x37h**

**A 1280W** € 220,00

DIMENSIONI ESTERNE LxPxH cm - EXTERNAL DIMENSIONS LxPxH cm  
DIMENSIONS EXTERIEURES LxPxH cm - AUßENABMESSUNGEN LxPxH cm **88x46x37h**

## Accessori per carrelli legno e acciaio - Accessories for wooden and steel trolley Accessoires pour chariot en bois et en acier - Zubehör für Holz und Stahlwagen

 Espositore ghiacciaia. Struttura in legno con vasca e griglia in acciaio inox. Cupola PLX. Provvisto di 8 contenitori eutettici.

 Ice-chest rack. Solid wooden frame. Stainless steel basin and grid. Plexiglass cover. Equipped with 8 eutetic each.



FOR MODELS:  
CL2000W - CL2001W - CL2150W - CL2151W - CL2590W - CL2591W - CL70 - CL90

**A 1290**

**€ 690,00**

DIMENSIONI ESTERNE LxPxH cm  
EXTERNAL DIMENSIONS LxPxH cm  
DIMENSIONS EXTERIEURES LxPxH cm  
AUBENABMESSUNGEN LxPxH cm

**90x48,5x23h**

 Espositeur glacière. Structure en bois massif. Cuve et grille en acier inoxydable. Cloche en plexiglass. Équipé avec 8 cartouches eutectiques.

 Eisauslage. Massivholzgestell. Schüssel und Gitter aus Edelstahl. Plexiglass-Deckel. Mit 8 Kühlplatten ausgestattet.



FOR MODELS:  
CL2000W - CL2001W - CL2150W - CL2151W - CL2590W - CL2591W - CL70W - CL90W

**A 1290W**

**€ 690,00**

DIMENSIONI ESTERNE LxPxH cm  
EXTERNAL DIMENSIONS LxPxH cm  
DIMENSIONS EXTERIEURES LxPxH cm  
AUBENABMESSUNGEN LxPxH cm

**90x48,5x23h**

 Vetrinetta. Struttura in legno. Cupola PLX.

 Wood veneer structure. Plexiglass cover.



FOR MODELS:  
CL2000W - CL2001W - CL2150W - CL2151W - CL2590W - CL2591W - CL70W - CL90W

**A 1299**

**€ 290,00**

DIMENSIONI ESTERNE LxPxH cm - EXTERNAL DIMENSIONS LxPxH cm  
DIMENSIONS EXTERIEURES LxPxH cm - AUBENABMESSUNGEN LxPxH cm

**70x50x22h**

**A 1298**

**€ 300,00**

DIMENSIONI ESTERNE LxPxH cm - EXTERNAL DIMENSIONS LxPxH cm  
DIMENSIONS EXTERIEURES LxPxH cm - AUBENABMESSUNGEN LxPxH cm

**90x50x22h**

 Structure en simil bois. Cloche en plexiglass.

 Gestell aus veredeltem Holz. Plexiglass-Deckel.



FOR MODELS:  
CL2000W - CL2001W - CL2150W - CL2151W - CL2590W - CL2591W - CL70W - CL90W

**A 1299W**

**€ 290,00**

DIMENSIONI ESTERNE LxPxH cm - EXTERNAL DIMENSIONS LxPxH cm  
DIMENSIONS EXTERIEURES LxPxH cm - AUBENABMESSUNGEN LxPxH cm

**70x50x22h**

**A 1298W**

**€ 300,00**

DIMENSIONI ESTERNE LxPxH cm - EXTERNAL DIMENSIONS LxPxH cm  
DIMENSIONS EXTERIEURES LxPxH cm - AUBENABMESSUNGEN LxPxH cm

**90x50x22h**

**Mobili di servizio - Serving furniture**  
**Meubles de service - Servicemöbel**

- 🇮🇹 Struttura in legno di alto spessore, due cassetti portaposate a 3 scomparti. Piani a giorno. Ruote multidirezionali.
- 🇬🇧 Extra thick wooden structure, two 3-compartments cutlery holder. Open shelves. Multidirectional wheels.

- 🇫🇷 Structure en bois de haute épaisseur avec deux porte-couverts à 3 compartiments. Étagères ouvertes. Roues pivotantes.
- 🇩🇪 Rahmen aus besonders starkem, veredeltem Holz, zwei Besteckkasten mit 3 Fächern. Offene Platten. Leichtlaufende Rollen.



Mobile sala basso. 2 sportelli.  
 Low service furniture. 2 doors.  
 Meuble de service de salle bas. 2 portes.  
 Niedriger Schrank mit 2 Türen.

Sportello superiore in plx fumé.  
 Upper door in plx gray colour.  
 Volet supérieur en plx couleur gris.  
 Obere Tür aus Sekuritglas.

**ML 3000 SS** € 590,00

**ML 3000 SSW (Wenge)** € 590,00

DIMENSIONI ESTERNE LxPxH cm  
 EXTERNAL DIMENSIONS LxPxH cm  
 DIMENSIONS EXTERIEURES LxPxH cm  
 AUBENABMESSUNGEN LxPxH cm

**95x49x99h**

**ML 3170 SS** € 870,00

**ML 3170 ST** € 960,00

DIMENSIONI ESTERNE LxPxH cm  
 EXTERNAL DIMENSIONS LxPxH cm  
 DIMENSIONS EXTERIEURES LxPxH cm  
 AUBENABMESSUNGEN LxPxH cm

**95x49x144h**

**Optionals**

**A250** Applicazione tramoggia per mobili - Bin for furniture - Tremie pour meubles - Behälter für möbel € 110,00

**A250W** (WENGÉ) Applicazione tramoggia per mobili - Bin for furniture - Tremie pour meubles - Behälter für möbel € 110,00





Mobile sala alto doppio, 1 sportello, 1 tramoggia.  
 High double furniture 1 door, 1 bin.  
 Double meuble de service de salle haut. 1 porte, 1 tremie.  
 Hoher Doppelschrank 1 Tür, 1 Behälter.

**ML 3150 ST** € 870,00

**ML 3150 STW WENGÉ** € 870,00

DIMENSIONI ESTERNE LxPxH cm  
 EXTERNAL DIMENSIONS LxPxH cm  
 DIMENSIONS EXTERIEURES LxPxH cm  
 AUBENABMESSUNGEN LxPxH cm

**95x49x144h**

Mobile sala alto doppio 2 sportelli.  
 High double furniture 2 doors.  
 Double meuble de service de salle haut 2 porte.  
 Hoher Doppelschrank 2 Türen.

**ML 3100 SS** € 760,00

**ML 3100 SSW WENGÉ** € 760,00

DIMENSIONI ESTERNE LxPxH cm  
 EXTERNAL DIMENSIONS LxPxH cm  
 DIMENSIONS EXTERIEURES LxPxH cm  
 AUBENABMESSUNGEN LxPxH cm

**95x49x144h**



Mobile sala alto singolo con sportello.  
 High service furniture with door.  
 Meuble de service de salle haut avec porte.  
 Hoher Einzelschrank mit 1 Tür.

**ML 3050 S** € 650,00

DIMENSIONI ESTERNE LxPxH cm  
 EXTERNAL DIMENSIONS LxPxH cm  
 DIMENSIONS EXTERIEURES LxPxH cm  
 AUBENABMESSUNGEN LxPxH cm

**45x49x144h**

**Mobili di servizio - Serving furniture**  
**Meubles de service - Servicemöbel**

- 🇮🇹 Struttura impiallacciata di rovere sbiancato. Due cassetti portapossate. Ruote multidirezionali. Struttura reggimensole a giorno in acciaio inox.
- 🇬🇧 Whitened oak veneered structure. Two cutlery holder drawers. Multidirectional wheels. Open stainless steel bracket holder.

- 🇫🇷 Structure plaquéé rouvre blanchi. Deux tiroirs à couverts roues pivotantes. Châssis porte-étagères ouvert en acier inox.
- 🇩🇪 Struktur von Gebleichtem Eichenholz Furniert. Zwei Besteckkasten Leichtlaufende Räder. Offener Plattenhaltergestell aus Edelstahl.



Mobile sala basso. 1 sportello.  
 Low service furniture. 1 door.  
 Meuble de service de salle bas. 1 portes.  
 Niedriger Schrank mit 1 Türen.

**ML 3200 S**

**€ 460,00**

DIMENSIONI ESTERNE LxPxH cm  
 EXTERNAL DIMENSIONS LxPxH cm  
 DIMENSIONS EXTERIEURES LxPxH cm  
 AUBENABMESSUNGEN LxPxH cm

**45x48x95h**



Mobile sala alto singolo con sportello.  
 High service furniture with door.  
 Meuble de service de salle haut avec porte.  
 Hoher Einzelsschrank mit 1 Tür.

**ML 3210 S**

**€ 660,00**

DIMENSIONI ESTERNE LxPxH cm  
 EXTERNAL DIMENSIONS LxPxH cm  
 DIMENSIONS EXTERIEURES LxPxH cm  
 AUBENABMESSUNGEN LxPxH cm

**45x48x155h**



Mobile sala basso. 2 sportelli.  
 Low service furniture. 2 doors.  
 Meuble de service de salle bas. 2 portes.  
 Niedriger Schrank mit 2 Türen.

**ML 3202 SS**

**€ 630,00**

DIMENSIONI ESTERNE LxPxH cm  
 EXTERNAL DIMENSIONS LxPxH cm  
 DIMENSIONS EXTERIEURES LxPxH cm  
 AUBENABMESSUNGEN LxPxH cm

**90x48x95h**



Mobile sala alto doppio 2 sportelli.  
 High double furniture. 2 doors.  
 Double meuble de service de salle haut 2 porte.  
 Hoher Doppelschrank 2 Türen.

**ML 3212 SS**

**€ 865,00**

DIMENSIONI ESTERNE LxPxH cm  
 EXTERNAL DIMENSIONS LxPxH cm  
 DIMENSIONS EXTERIEURES LxPxH cm  
 AUBENABMESSUNGEN LxPxH cm

**90x48x155h**

**Optionals**

**A260**

Applicazione tramoggia per mobili - Bin for furniture - Tremie pour meubles - Behälter für möbel

**€ 110,00**



Mobile sala basso. 2 sportelli. 3 cassetti.  
Low service furniture. 2 doors. 3 drawers.  
Meuble de service de salle bas. 2 portes. 3 tiroirs.  
Niedriger Schrank mit 2 Türen. 3 Schubladen.

**ML 3204 SS**

**€ 820,00**

DIMENSIONI ESTERNE LxPxH cm  
EXTERNAL DIMENSIONS LxPxH cm  
DIMENSIONS EXTERIEURES LxPxH cm  
AUBENABMESSUNGEN LxPxH cm

**136x48x95h**



Mobile sala alto doppio 2 sportelli. 3 cassetti.  
High double furniture. 2 doors. 3 drawers.  
Double meuble de service de salle haut 2 porte. 3 tiroirs.  
Hoher Doppelschrank 2 Türen. 3 Schubladen.

**ML 3214 SS**

**€ 1.100,00**

DIMENSIONI ESTERNE LxPxH cm  
EXTERNAL DIMENSIONS LxPxH cm  
DIMENSIONS EXTERIEURES LxPxH cm  
AUBENABMESSUNGEN LxPxH cm

**136x48x155h**

- 🇮🇹 Struttura impiallicciata di wengé. Due cassetti portaposate. Ruote multidirezionali. Struttura reggimensole a giorno in acciaio inox.
- 🇬🇧 Wengé oak veenered structure. Two cutlery holder drawers. Multidirectional wheels. Open stainless steel bracket holder.

- 🇫🇷 Structure plaquéé rouvre wengé. Deux tiroirs à couverts roues pivotantes. Châssis porte-étagères ouvert en acier inox.

- 🇩🇪 Struktur von Wenge Eichenholz Furniert. Zwei Besteckkasten Leichtlaufende Räder. Offener Plattenhaltergestell aus Edelstahl.



Mobile sala basso. 1 sportello.  
 Low service furniture. 1 door.  
 Meuble de service de salle bas. 1 portes.  
 Niedriger Schrank mit 1 Türen.

**ML 3200 SW**

**€ 460,00**

**ML 3200 SN**

**€ 460,00**

DIMENSIONI ESTERNE LxPxH cm  
 EXTERNAL DIMENSIONS LxPxH cm  
 DIMENSIONS EXTERIEURES LxPxH cm  
 AUßENABMESSUNGEN LxPxH cm

**45x48x95h**

Mobile sala alto singolo con sportelli.  
 High service furniture with door.  
 Meuble de service de salle haut avec porte.  
 Hoher Einzelschrank mit 1 Tür.

**ML 3210 SW**

**€ 660,00**

**ML 3210 SN**

**€ 660,00**

DIMENSIONI ESTERNE LxPxH cm  
 EXTERNAL DIMENSIONS LxPxH cm  
 DIMENSIONS EXTERIEURES LxPxH cm  
 AUßENABMESSUNGEN LxPxH cm

**45x48x155h**



Mobile sala basso. 2 sportelli.  
 Low service furniture. 2 doors.  
 Meuble de service de salle bas. 2 portes.  
 Niedriger Schrank mit 2 Türen.

Mobile sala alto doppio 2 sportelli.  
 High double furniture. 2 doors.  
 Double meuble de service de salle haut 2 porte.  
 Hoher Doppelschrank 2 Türen.

**ML 3202 SSW** € 630,00

**ML 3212 SSW** € 865,00

**ML 3202 SSN** € 630,00

**ML 3212 SSN** € 865,00

DIMENSIONI ESTERNE LxPxH cm  
 EXTERNAL DIMENSIONS LxPxH cm  
 DIMENSIONS EXTERIEURES LxPxH cm  
 AUBENABMESSUNGEN LxPxH cm

**90x48x95h**

DIMENSIONI ESTERNE LxPxH cm  
 EXTERNAL DIMENSIONS LxPxH cm  
 DIMENSIONS EXTERIEURES LxPxH cm  
 AUBENABMESSUNGEN LxPxH cm

**90x48x155h**

### Optionals

**A270** Applicazione tramoggia per mobili - Bin for furniture - Tremie pour meubles - Behälter für möbel

**€ 110,00**



Mobile sala basso. 2 sportelli. 3 cassetti.  
 Low service furniture. 2 doors. 3 drawers.  
 Meuble de service de salle bas. 2 portes. 3 tiroirs.  
 Niedriger Schrank mit 2 Türen. 3 Schubladen.

**ML 3204 SSW**

**€ 820,00**

**ML 3204 SSN**

**€ 820,00**

DIMENSIONI ESTERNE LxPxH cm  
 EXTERNAL DIMENSIONS LxPxH cm  
 DIMENSIONS EXTERIEURES LxPxH cm  
 AUßENABMESSUNGEN LxPxH cm

**136x48x95h**



Mobile sala alto doppio. 2 sportelli. 3 cassetti.  
 High double furniture. 2 doors. 3 drawers.  
 Double meuble de service de salle haut. 2 porte. 3 tiroirs.  
 Hoher Doppelschrank. 2 Türen. 3 Schubladen.

**ML 3214 SSW**

**€ 1.100,00**



**ML 3214 SSN**



**€ 1.100,00**

DIMENSIONI ESTERNE LxPxH cm  
 EXTERNAL DIMENSIONS LxPxH cm  
 DIMENSIONS EXTERIEURES LxPxH cm  
 AUßENABMESSUNGEN LxPxH cm

**136x48x155h**

**Mobili di servizio - Serving furniture**  
**Meubles de service - Servicemöbel**

-  Struttura impiallacciata colore noce e wengé. cassetti portaposate. Ruote multidirezionali. Struttura reggi pensili a giorno in acciaio plastificato.
-  Veneered structure walnut and wengé colour. Cutlery drawers. Multi-directional wheels. Open wall units holder in plastic coated steel.

-  Structure plaquée couleur noyer et wengé. Tiroirs à couverts. Roues pivotantes Structure soutenant les éléments muraux ouverts en acier plastifié.
-  Furnierte Struktur, Farbe Nussbraun und Wengé. Besteckkasten. Drehbare Räder Offene Wandschrankstruktur aus plastifiziertem Stahl.



Mobile sala alto doppio 2 sportelli. 3 cassetti. 3 pensili.  
 High double furniture. 2 doors. 3 drawers. 3 wall units.  
 Double meuble de service de salle haut. 2 porte. 3 tiroirs. 3 meubles muraux.  
 Hoher Doppelschrank 2 Türen. 3 Schubladen. 3 Wandschränke.

**ML 3214SSPN € 1.320,00**

**ML 3214SPW € 1.320,00**

DIMENSIONI ESTERNE LxPxH cm  
 EXTERNAL DIMENSIONS LxPxH cm  
 DIMENSIONS EXTERIEURES LxPxH cm  
 AUBENABMESSUNGEN LxPxH cm

**137x48x153h**

Mobile sala alto doppio 2 sportelli. 2 cassetti. 2 pensili.  
 High double furniture. 2 doors. 2 drawers. 2 wall units.  
 Double meuble de service de salle haut 2 porte. 2 tiroirs. 2 meubles muraux.  
 Hoher Doppelschrank 2 Türen. 2 Schubladen. 2 Wandschränke.

**ML 3212SSPN € 1.060,00**

**ML 3212SPW € 1.060,00**

DIMENSIONI ESTERNE LxPxH cm  
 EXTERNAL DIMENSIONS LxPxH cm  
 DIMENSIONS EXTERIEURES LxPxH cm  
 AUBENABMESSUNGEN LxPxH cm

**92x48x153h**





**Carrelli di servizio inox**   
**Carrelli di servizio inox trasporto pesante**  
**Dolci, formaggi e antipasti**  
**Carrello multiuso in plastica con montanti**  
**in alluminio anodizzato**



**Stainless steel service trolleys**   
**Stainless steel service trolleys heavy transport**  
**Cake, cheese and hors d'oeuvres trolley**  
**Plastic multi-service trolley with upright**  
**in anodised aluminium**

**Chariots de service inox**   
**Chariots de service inox transport lourd**  
**Chariot pour dessert, fromages et hors d'oeuvres**  
**Chariot multiservice en plastique avec montants**  
**en aluminium anodisé**

**Servicewagen aus Edelstahl**   
**Servicewagen aus Edelstahl Schwer transport**  
**Kuchen, Käse und Vorspeisen Servierwagen**  
**Allzweckplastikwagen mit Pfosten**  
**aus eloxiert Aluminium**

**Carrello multiuso in plastica - Plastic multi-service trolley**  
**Chariot multiservice en plastique - Allzweckplastikwagen**

-  Carrello multiuso in plastica con montanti in alluminio anodizzato.
-  Plastic multi-service trolley with upright in anodised aluminium.

-  Chariot multiservice en plastique avec montants en aluminium anodisé.
-  Allzweckplastikwagen mit Pfosten aus eloxiert Aluminium.



**CP 1008**

**€ 90,00**

DIMENSIONI ESTERNE LxPxH cm  
 EXTERNAL DIMENSIONS LxPxH cm  
 DIMENSIONS EXTERIEURES LxPxH cm  
 AUBENABMESSUNGEN LxPxH cm

**85x43x95h**



**CP 1010**

**€ 135,00**

DIMENSIONI ESTERNE LxPxH cm  
 EXTERNAL DIMENSIONS LxPxH cm  
 DIMENSIONS EXTERIEURES LxPxH cm  
 AUBENABMESSUNGEN LxPxH cm

**102x50x96h**



A 1001





A 1002

**Optionals**

- |              |   |                |
|--------------|---|----------------|
| <b>A1001</b> | Cestino piccolo - Small basket<br>Petit panier - Klein Korb (per/for CP 1010) | <b>€ 10,00</b> |
| <b>A1002</b> | Cestino grande - Big basket<br>Grand panier - Gros Korb (per/for CP 1010)     | <b>€ 22,00</b> |

## Carrelli di servizio inox - Stainless steel service trolleys Chariots de service inox - Servicewagen aus Edelstahl

 Struttura acciaio inox - Piano in nobilitato con cornice perimetrale in acciaio inox. Ruote multidirezionali. Paracolpi in gomma.

 Extra thick squared tubular structure. High quality wood veneer shelves with surrounding steel frame. Multidirectional wheels, rubber buffer.



WENGE - CA 1000W

 Structure en acier tubulaire carré de haute épaisseur. Rayons en similbois et corniche périmétrale en acier. Quatre roues pivotantes. Butoir en gomme.

 Struktur aus viereckigen sehr starkem Röhrr Stahl. Flächen aus verbessertem Holz mit umfassungsrahmen Ausstahl. Multirichträder. Gummipuffer.

**CA 1000** € 250,00

**CA 1000W** € 250,00

DIMENSIONI ESTERNE LxPxH cm  
EXTERNAL DIMENSIONS LxPxH cm  
DIMENSIONS EXTERIEURES LxPxH cm  
AUBENABMESSUNGEN LxPxH cm

**83x57x97h**

**CA 1001** € 260,00

**CA 1001W** € 260,00

DIMENSIONI ESTERNE LxPxH cm  
EXTERNAL DIMENSIONS LxPxH cm  
DIMENSIONS EXTERIEURES LxPxH cm  
AUBENABMESSUNGEN LxPxH cm

**103x57x97h**

*Due piani  
Two shelves  
Deux rayons  
Zwei platten*



NOCE - CA 1050

**CA 1050** € 330,00

**CA 1050W** € 330,00

DIMENSIONI ESTERNE LxPxH cm  
EXTERNAL DIMENSIONS LxPxH cm  
DIMENSIONS EXTERIEURES LxPxH cm  
AUBENABMESSUNGEN LxPxH cm

**83x57x97h**

**CA 1051** € 350,00

**CA 1051W** € 350,00

DIMENSIONI ESTERNE LxPxH cm  
EXTERNAL DIMENSIONS LxPxH cm  
DIMENSIONS EXTERIEURES LxPxH cm  
AUBENABMESSUNGEN LxPxH cm

**103x57x97h**

*3 piani  
3 shelves  
3 rayons  
3 Platten*

**Carrelli di servizio inox - Stainless steel service trolleys**  
**Chariots de service inox - Servicewagen aus Edelstahl**



Multiservizi - 4 Piani  
 Multiservice - 4 Shelves  
 Charlot multiservice - 4 Rayons  
 Mehrzweckwagen - 4 Platten

**CA 1070**

**€ 430,00**

DIMENSIONI ESTERNE LxPxH cm  
 EXTERNAL DIMENSIONS LxPxH cm  
 DIMENSIONS EXTERIEURES LxPxH cm  
 AUBENABMESSUNGEN LxPxH cm

**83x57x172h**

**CA 1071**

**€ 455,00**

DIMENSIONI ESTERNE LxPxH cm  
 EXTERNAL DIMENSIONS LxPxH cm  
 DIMENSIONS EXTERIEURES LxPxH cm  
 AUBENABMESSUNGEN LxPxH cm

**103x57x172h**



🇮🇹 Struttura in acciaio inox. Piani in acciaio inox piegati, satinati, insonorizzati. Ruote multidirezionali. Paracolpi in gomma. Portata complessiva 80 Kg.

🇬🇧 Stainless steel structur. Stainless steel folded, anti-noise and sated shelves. Multidirectional wheels. Rubber buffer. Total capacity 80 Kg.

🇫🇷 Structure en acier inoxydable. Rayons en acier inoxydable, pliés, antibruits et satinés. Roues pivotantes. Butoir en gomme. Portée totale 80 Kg.

🇩🇪 Gestell aus rostfreiem Stahl. Gebogene, Schallgedämmte mit satinierter Oberfläche Platten aus rostfreiem Stahl. Leichtlaufende Rollen Gummipuffer. Tragfähigkeit 80 Kg.

**CA 1382**

**€ 250,00**

DIMENSIONI ESTERNE LxPxH cm - EXTERNAL DIMENSIONS LxPxH cm  
 DIMENSIONS EXTERIEURES LxPxH cm - AUBENABMESSUNGEN LxPxH cm

**83x57x97h**

**CA 1383**

**€ 270,00**

DIMENSIONI ESTERNE LxPxH cm - EXTERNAL DIMENSIONS LxPxH cm  
 DIMENSIONS EXTERIEURES LxPxH cm - AUBENABMESSUNGEN LxPxH cm

**103x57x97h**

*2 Piani - 2 Shelves - 2 Rayons - 2 Platten*



**Optionals**

**A1001**

Cestino piccolo - Small basket  
 Petit panier - Klein Korb

**€ 10,00**

**A1002**

Cestino grande - Big basket  
 Grand panier - Gros Korb

**€ 22,00**

## Carrelli di servizio inox - Stainless steel service trolleys Chariots de service inox - Servicewagen aus Edelstahl



 Struttura in acciaio inox. Piani in acciaio inox piegati, satinati, insonorizzati. Ruote multidirezionali. Paracolpi in gomma. Portata complessiva 80 Kg.

 Stainless steel structur. Stainless steel folded, anti-noise and sated shelves. Multidirectional wheels. Rubber buffer. Total capacity 80 Kg.

 Structure en acier inoxydable. Rayons en acier inoxydable, pliés, antibruits et satinés. Roues pivotantes. Butoir en gomme. Portée totale 80 Kg.

 Gestell aus rostfreiem Stahl. Gebogene, Schallgedämmte mit satinierter Oberfläche Platten aus rostfreiem Stahl. Leichtlaufende Rollen Gummipuffer. Tragfähigkeit 80 Kg.

**CA 1384** € 330,00

DIMENSIONI ESTERNE LxPxH cm - EXTERNAL DIMENSIONS LxPxH cm  
DIMENSIONS EXTERIEURES LxPxH cm - AUßENABMESSUNGEN LxPxH cm **83x57x97h**

**CA 1385** € 360,00

DIMENSIONI ESTERNE LxPxH cm - EXTERNAL DIMENSIONS LxPxH cm  
DIMENSIONS EXTERIEURES LxPxH cm - AUßENABMESSUNGEN LxPxH cm **103x57x97h**

3 Piani - 3 Shelves - 3 Rayons - 3 Platten

### Optionals

**A1001** Cestino piccolo - Small basket  
Petit panier - Klein Korb € 10,00

**A1002** Cestino grande - Big basket  
Grand panier - Gros Korb € 22,00

Multiservizi - 4 Piani  
Multiservice - 4 Shelves  
Charlot multiservice - 4 Rayons  
Mehrzweckwagen - 4 Platten

**CA 1380** € 435,00

DIMENSIONI ESTERNE LxPxH cm  
EXTERNAL DIMENSIONS LxPxH cm  
DIMENSIONS EXTERIEURES LxPxH cm  
AUßENABMESSUNGEN LxPxH cm **83x57x172h**

**CA 1381** € 475,00

DIMENSIONI ESTERNE LxPxH cm  
EXTERNAL DIMENSIONS LxPxH cm  
DIMENSIONS EXTERIEURES LxPxH cm  
AUßENABMESSUNGEN LxPxH cm **103x57x172h**

### Optionals

**A1001** Cestino piccolo con supporto - Little basket stand  
Petit panier avec support - Kleiner korb mit halterung (per/for CA 1382/83/84/85) € 10,00

**A1002** Cestino grande - Big basket  
Grand panier - Gros Korb (per/for CA 1382/83/84/85) € 22,00

## Carrelli di servizio inox - Stainless steel service trolleys

### Chariots de service inox - Servicewagen aus Edelstahl

 Struttura tubolare acciaio inox tonda Ø 25, alto spessore con piani stampati in forma di vassoio con bordi arrotondati - insonorizzati con finitura satinata - Ruote multidirezionali. Paracolpi in gomma. Portata complessiva Kg 100.

 Extra thick tubular stainless steel structure Ø 25. Tray - shape moulded shelves. Rounded edges. Anti-noise satined finish. Multidirectional wheels. Rubber buffer. Total capacity 100 Kg.



 Structure en acier inox tubulaire de haute épaisseur Ø 25. Rayons estampés a forme de plateau. Bord arrondi. Finissage satiné anti-bruit. Roues pivotantes. Butoir en gomme. Portée totale 100 Kg.

 Gestell aus sehr starkem, viereckigem Stahlrohr Ø 25, bedruckte, tablettförmige Platten mit abgerundeten Kanten, schallgedämmt, mit satinierte Oberfläche. Leichtlaufende Rollen Gummipuffer. Tragfähigkeit 100 Kg.

2 piani  
2 Shelves  
2 Rayons  
2 Platten

**CA 1390**

**€ 250,00**

DIMENSIONI ESTERNE LxPxH cm  
EXTERNAL DIMENSIONS LxPxH cm  
DIMENSIONS EXTERIEURES LxPxH cm  
AUBENABMESSUNGEN LxPxH cm

**87x59x93h**

**CA 1391**

**€ 260,00**

DIMENSIONI ESTERNE LxPxH cm  
EXTERNAL DIMENSIONS LxPxH cm  
DIMENSIONS EXTERIEURES LxPxH cm  
AUBENABMESSUNGEN LxPxH cm

**109x59x93h**



3 piani  
3 Shelves  
3 Rayons  
3 Platten

**CA 1410**

**€ 320,00**

DIMENSIONI ESTERNE LxPxH cm  
EXTERNAL DIMENSIONS LxPxH cm  
DIMENSIONS EXTERIEURES LxPxH cm  
AUBENABMESSUNGEN LxPxH cm

**87x59x103h**

**CA 1411**

**€ 340,00**

DIMENSIONI ESTERNE LxPxH cm  
EXTERNAL DIMENSIONS LxPxH cm  
DIMENSIONS EXTERIEURES LxPxH cm  
AUBENABMESSUNGEN LxPxH cm

**109x59x103h**

**Carrelli di servizio inox - Stainless steel service trolleys**  
**Chariots de service inox - Servicewagen aus Edelstahl**



4 piani  
 4 Shelves  
 4 Rayons  
 4 Platten

**CA 1424** € 420,00

DIMENSIONI ESTERNE LxPxH cm  
 EXTERNAL DIMENSIONS LxPxH cm  
 DIMENSIONS EXTERIEURES LxPxH cm  
 AUBENABMESSUNGEN LxPxH cm

**87x59x140h**

**CA 1425** € 450,00

DIMENSIONI ESTERNE LxPxH cm  
 EXTERNAL DIMENSIONS LxPxH cm  
 DIMENSIONS EXTERIEURES LxPxH cm  
 AUBENABMESSUNGEN LxPxH cm

**109x59x140h**



5 piani  
 5 Shelves  
 5 Rayons  
 5 Platten

**CA 1426** € 500,00

DIMENSIONI ESTERNE LxPxH cm  
 EXTERNAL DIMENSIONS LxPxH cm  
 DIMENSIONS EXTERIEURES LxPxH cm  
 AUBENABMESSUNGEN LxPxH cm

**87x59x170h**

**CA 1427** € 540,00

DIMENSIONI ESTERNE LxPxH cm  
 EXTERNAL DIMENSIONS LxPxH cm  
 DIMENSIONS EXTERIEURES LxPxH cm  
 AUBENABMESSUNGEN LxPxH cm



**109x59x170h**



**Optionals**

**A512** Ruote con freno - Wheels with catch - Roues avec frein - Räder mit Bremse € 7,00 cad./each

## Carrelli di servizio inox - Stainless steel service trolleys

### Chariots de service inox - Servicewagen aus Edelstahl

-  Carrello struttura acciaio inox con fori e sacchi porta rifiuti ruote multidirezionali paracolpi in gomma (sacchi esclusi).
-  Trolley with stainless steel structure, with holes and waste sacks. Multi-directional wheels. Rubber buffers (Sacks not included).

-  Chariot avec chassis en acier inox avec trous et sacs de litières. Roues pivotantes. Butoirs en caoutchouc (Sacs pas compris).
-  Wagen mit Struktur aus Edelstahl mit Lochern und Abfallsäcken. Drehbare Räder. Gummipuffer (Säcke nicht inbegriffen).



#### CA 1390S

€ 300,00

DIMENSIONI ESTERNE LxPxH cm  
EXTERNAL DIMENSIONS LxPxH cm  
DIMENSIONS EXTERIEURES LxPxH cm  
AUBENABMESSUNGEN LxPxH cm

89x59x93h

#### CA 1391S

€ 320,00

DIMENSIONI ESTERNE LxPxH cm  
EXTERNAL DIMENSIONS LxPxH cm  
DIMENSIONS EXTERIEURES LxPxH cm  
AUBENABMESSUNGEN LxPxH cm

109x59x93h



#### CA 1391S2

€ 370,00

DIMENSIONI ESTERNE LxPxH cm  
EXTERNAL DIMENSIONS LxPxH cm  
DIMENSIONS EXTERIEURES LxPxH cm  
AUBENABMESSUNGEN LxPxH cm

109x59x93h





## Carrelli di servizio inox - Stainless steel service trolleys Chariots de service inox - Servicewagen aus Edelstahl

 **CARRELLO ACCIAIO INOX DA SBARAZZO.** Vasca superiore inox h 150 insonorizzata. Piano inferiore inox piegato. Ruote multidirezionali. Paracolpi in gomma. Portata complessiva Kg 80.

 **STAINLESS STEEL CLEARING TROLLEY.** Stainless steel upper basin h 150 anti-noise. Stainless steel shelf below, folded. Multidirectional wheels. Rubber buffer. Total capacity 80 Kg.



 **CHARIOT DE RANGEMENT.** Cuve supérieure en acier inoxydable h 150 antibruits. Rayon inférieur en acier inoxydable, plié. Roues pivotantes. Butoir en gomme. Portée totale 80 Kg.

 **EN ACIER INOX - ABLAGEWAGEN AUS INOX-STAH.** Schallgedämmtes oberes Becken aus Edelstahl h 150. gebogene untere Platte aus Edelstahl. Leichtlaufende Rollen, Gummipuffer. Tragfähigkeit 80 Kg.

2 vasche 150 h.  
2 - 150 h basins  
2 cuves 150 h  
2 Becken 150 h

**CA 1389**

**€ 435,00**

DIMENSIONI ESTERNE LxPxH cm  
EXTERNAL DIMENSIONS LxPxH cm  
DIMENSIONS EXTERIEURES LxPxH cm  
AUBENABMESSUNGEN LxPxH cm

**101x57x97h**



1 vasca 150 h.  
1 - 150 h sasin  
1 cuve 150 h  
1 Becken 150 h.

**CA 1388**

**€ 380,00**

DIMENSIONI ESTERNE LxPxH cm  
EXTERNAL DIMENSIONS LxPxH cm  
DIMENSIONS EXTERIEURES LxPxH cm  
AUBENABMESSUNGEN LxPxH cm

**101x57x97h**

**Carrelli di servizio inox - Stainless steel service trolleys**  
**Chariots de service inox - Servicewagen aus Edelstahl**



2 vasche 65 h.  
 2 - 65 h basin  
 2 cuve 65 h  
 2 Becken 65 h.

**CA 1396**

**€ 310,00**

DIMENSIONI ESTERNE LxPxH cm  
 EXTERNAL DIMENSIONS LxPxH cm  
 DIMENSIONS EXTERIEURES LxPxH cm  
 AUBENABMESSUNGEN LxPxH cm

**91x57x97h**



 CARRELLO PORTABACINELLE GN. Struttura in acciaio inox. Piano inferiore in acciaio inox piegato, insonorizzato. Ruote multidirezionali. Paracolpi in gomma. Bacinelle escluse.

 GN BASIN TROLLEY. Stainless steel structure. Stainless steel shelf below, folded and antinoise. Multidirectional wheels. Rubber buffer. Containers not included.

 CHARIOT PORTE-BAC GN. Chariot porte-cuvettes GN. Structure en acier inoxydable. Rayon inférieur en acier inoxydable, plié et anti-bruits. Roues pivotantes. Butoir en gomme. Cuvettes exclues.

 SCHÜSSEL-WAGEN GN. GN behälterwagen. Gestell aus rostfreiem Stahl. gebogene, Schallgeduammte untere Platte aus rostfreiem Stahl. Leichtlaufende Rollen. Gummipuffer. Behälter nicht einbezogen.

**CA 1386**

**€ 220,00**

DIMENSIONI ESTERNE LxPxH cm  
 EXTERNAL DIMENSIONS LxPxH cm  
 DIMENSIONS EXTERIEURES LxPxH cm  
 AUBENABMESSUNGEN LxPxH cm

**N° 2 GN 1/1**  
**77x62x97h**

**CA 1387**

**€ 240,00**

DIMENSIONI ESTERNE LxPxH cm  
 EXTERNAL DIMENSIONS LxPxH cm  
 DIMENSIONS EXTERIEURES LxPxH cm  
 AUBENABMESSUNGEN LxPxH cm

**N° 3 GN 1/1**  
**110x62x97h**

**Optionals**

**A512** Ruote con freno - Wheels with catch - Roues avec frein - Räder mit Bremse

**€ 7,00 cad./each**

## Carrelli di servizio inox - Stainless steel service trolleys Chariots de service inox - Servicewagen aus Edelstahl

🇮🇹 Struttura tubolare acciaio inox tonda Ø 25, alto spessore con piani stampati in forma di vassoio con bordi arrotondati - insonorizzati con finitura satinata - Ruote multidirezionali. Paracolpi in gomma. Portata complessiva Kg 150.

🇬🇧 Extra thick tubular stainless steel structure Ø 25. Tray - shape moulded shelves. Rounded edges. Anti-noise satined finish. Multidirectional wheels. Rubber buffer. Total capacity 150 Kg.

🇫🇷 Structure en acier inox tubulaire de haute épaisseur Ø 25. Rayons estampés a forme de plateau. Bord arrondi. Finissage satiné anti-bruit. Roues pivotantes. Butoir en gomme. Portée totale 150 Kg.

🇩🇪 Gestell aus sehr starkem, viereckigem Stahlrohr Ø 25, bedruckte, tabletförmige Platten mit abgerundeten Kanten, schallgedämmt, mit satinierte Oberfläche. Leichtlaufende Rollen Gummipuffer. Tragfähigkeit 150 Kg.



**CA 1430**

**€ 380,00**

DIMENSIONI ESTERNE LxPxH cm  
EXTERNAL DIMENSIONS LxPxH cm  
DIMENSIONS EXTERIEURES LxPxH cm  
AUBENABMESSUNGEN LxPxH cm

**109x59x100h**  
2 piani / 2 Shelves  
2 Rayons / 2 Platten



**CA 1431**

**€ 450,00**

DIMENSIONI ESTERNE LxPxH cm  
EXTERNAL DIMENSIONS LxPxH cm  
DIMENSIONS EXTERIEURES LxPxH cm  
AUBENABMESSUNGEN LxPxH cm

**109x59x100h**  
3 piani / 3 Shelves  
3 Rayons / 3 Platten

### Optionals

SU RICHIESTA SPEDITI ANCHE SMONTATI - ON REQUEST DELIVERED NOT MOUNTED - SUR DEMANDE ENVOYÉS DEMONTÉS - AUF ANFRAGE DEMONTIERT GELIEFERT

**Carrelli di servizio inox - Stainless steel service trolleys**  
**Chariots de service inox - Servicewagen aus Edelstahl**



**CA 1432**

**€ 550,00**

DIMENSIONI ESTERNE LxPxH cm  
EXTERNAL DIMENSIONS LxPxH cm  
DIMENSIONS EXTERIEURES LxPxH cm  
AUBENABMESSUNGEN LxPxH cm

**109x59x130h**  
4 piani / 4 Shelves  
4 Rayons / 4 Platten



**CA 1433**

**€ 640,00**

DIMENSIONI ESTERNE LxPxH cm  
EXTERNAL DIMENSIONS LxPxH cm  
DIMENSIONS EXTERIEURES LxPxH cm  
AUBENABMESSUNGEN LxPxH cm

**109x59x160h**  
5 piani / 5 Shelves  
5 Rayons / 5 Platten

**Optionals**

**A517** Ruote con freno - Wheels with catch - Roues avec frein - Räder mit Bremse

**€ 14,00 cad./each**

## Carrelli di servizio inox trasporto pesante - Stainless steel service trolleys heavy transport Chariots de service inox transport lourd - Servicewagen aus Edelstahl Schwer transport

🇮🇹 Struttura in acciaio inox 25x25. Piano in acciaio inox piegati con omega di rinforzo, satinati, insonorizzati. Ruote multidirezionali. Paracolpi in gomma. Portata complessiva 200 Kg.

🇬🇧 Stainless steel structur. Stainless steel folded, anti-noise and satined shelves with reinforcements. Multidirectional wheels. Rubber buffer. Total capacity 200 Kg.

🇫🇷 Structure en acier inoxydable. Rayons en acier inoxydable, pliés, antibruits et satinés avec bourrelets de renforcement. Roues pivotantes. Butoir en gomme. Portée totale 200 Kg.

🇩🇪 Gestell aus rostfreiem Stahl. Gebogene, schallgedämmte mit satinierte Oberfläche Platten aus rostfreiem Stahl mit verstärkungsrippen. Leichtlaufende Rollen Gummipuffer. Tragfähigkeit 200 Kg.



**CA 1393P**

**€ 415,00**

DIMENSIONI ESTERNE LxPxH cm  
EXTERNAL DIMENSIONS LxPxH cm  
DIMENSIONS EXTERIEURES LxPxH cm  
AUBENABMESSUNGEN LxPxH cm

**111x66x98h**



**CA 1395P**

**€ 565,00**

DIMENSIONI ESTERNE LxPxH cm  
EXTERNAL DIMENSIONS LxPxH cm  
DIMENSIONS EXTERIEURES LxPxH cm  
AUBENABMESSUNGEN LxPxH cm

**111x66x98h**

### Optionals

**A514**

Ruote con freno - Wheels with catch - Roues avec frein - Räder mit Bremse

**€ 9,00 cad./each**

## Dolci, formaggi e antipasti - Cake, cheese and hors d'oeuvres trolley

## Chariot pour dessert, fromages et hors d'oeuvres - Kuchen, Käse und Vorspeisen Servierwagen



- Refrigerato con 8 piastre eutettiche adatto per dolci, formaggi, salumi e antipasti. Può contenere n° 5 bacinelle GN 1/4 h 65 e n° 5 1/6 h 65. Portata complessiva kg 80.
- Refrigerated with 8 eutectic plates suitable for desserts, cheese, sausages and hors-d'oeuvres. It can hold 5 GN basins 1/4 H. 65 and 5 1/6 H. 65. Total capacity 80 Kg.
- Réfrigéré à 8 plaques eutectiques, indiqué pour les gâteaux, les fromages, la charcuterie et les hors-d'oeuvres. Peut contenir 5 bacs GN 1/4 h.65 et 5 bacs 1/6 h.65. Portée totale 80 Kg.
- Kühlung mit 8 eutektischen Platten, geeignet für Süßspeisen, Käse, Wurst und Vorspeisen. Kann 5 Schüsseln GN 1/4 h 65 und 5 1/6 h 65 aufnehmen. Tragfähigkeit 80 Kg.

**CA 1165**

**€ 870,00**

DIMENSIONI ESTERNE LxPxH cm  
EXTERNAL DIMENSIONS LxPxH cm  
DIMENSIONS EXTERIEURES LxPxH cm  
AUBENABMESSUNGEN LxPxH cm

**108x57x103 h**



- Struttura in acciaio inox. Piani in acciaio inox piegati, satinati, insonorizzati. Ruote multidirezionali. Paracolpi in gomma. Cupola in plx.
- Stainless steel structur. Stainless steel folded, anti-noise and sated shelves. Multidirectional wheels. Rubber buffer.
- Structure en acier inoxydable. Rayons en acier inoxydable. Rayons en acier inoxydable, pliés, antibruits et satinés. Roues pivotantes. Butoir en gomme.
- Gebogene, Schallgedämmte mit satinierter Oberfläche Platten aus rostfreiem Stahl. Leichtlaufende Rollen Gummipuffer.

**CA 1162**

**€ 540,00**

DIMENSIONI ESTERNE LxPxH cm  
EXTERNAL DIMENSIONS LxPxH cm  
DIMENSIONS EXTERIEURES LxPxH cm  
AUBENABMESSUNGEN LxPxH cm

**118x57x103h**  
2 piani / 2 Shelves  
2 Rayons / 2 Platten

**CA 1163**

**€ 625,00**

DIMENSIONI ESTERNE LxPxH cm  
EXTERNAL DIMENSIONS LxPxH cm  
DIMENSIONS EXTERIEURES LxPxH cm  
AUBENABMESSUNGEN LxPxH cm

**118x57x103h**  
3 piani / 3 Shelves  
3 Rayons / 3 Platten

## **Dolci, formaggi e antipasti - Cake, cheese and hors d'oeuvres trolley** **Chariot pour dessert, fromages et hors d'oeuvres - Kuchen, Käse und Vorspeisen Servierwagen**

**REGGIPIATTO E CASSETTO PORTAPOSATE OPTIONAL** Struttura acciaio inox - Piano in nobilitato con cornice perimetrale in acciaio inox. Ruote multidirezionali Ø125. Paracolpi in gomma. Cupola in plx. Il carrello in foto è con accessori A 100 porta piatti e A 200 cassetto portaposate.

**PLATE AND CUTLERY HOLDER ON REQUEST** Extra thick squared tubular structure in stainless steel. Two high quality wood veneer shelves with surrounding steel frame. Four multidirectional wheels Ø 125. rubber buffer. The trolley pictured includes accessories A100 plate holder and A200 cutlery tray.

**PORTE-ASSIETTE ET PORTE-COUVERTS SUR DEMANDE** Structure en acier inox tubulaire carré de haute épaisseur avec deux rayons en similibois et corniche périmétrale en acier inox. Quatre roues pivotantes Ø 125. Butoir en gomme. Le chariot illustré sur la photo est doté des accessoires A100 porte-assiettes et A200 tiroir à couverts.

**TELLERHALTER UND BESTECKKASTEN AUF ANFRAGE** Struktur aus viereckigen sehr starkem Edelstahl. Zwei Flächen aus verbessertem Holz mit Umfassungsrahmen aus Edelstahl. Vier Multirichträder Ø 125. Gummipuffer. Der Wagen auf dem Photo ist mit Zubehör A100, Tellerhalter, und A200, Besteckkasten.



**CA 1320** € 460,00

**CA 1320W** € 460,00

DIMENSIONI ESTERNE LxPxH cm  
EXTERNAL DIMENSIONS LxPxH cm  
DIMENSIONS EXTERIEURES LxPxH cm  
AUBENABMESSUNGEN LxPxH cm

**90x57x103h**

**CA 1321** € 520,00

**CA 1321W** € 520,00

DIMENSIONI ESTERNE LxPxH cm  
EXTERNAL DIMENSIONS LxPxH cm  
DIMENSIONS EXTERIEURES LxPxH cm  
AUBENABMESSUNGEN LxPxH cm

**110x57x103h**

**ATTENZIONE!** Le foto sono con OPTIONAL  
**ATTENTION!** Photos shown on the catalogue are with OPTIONAL  
**ATTENTION!** Les photos sur le catalogue sont avec OPTIONAL  
**ACHTUNG!** Die Photo auf dem Katalog sind EXTRAUSSTATTUNG

### **Optionals**

**A100** CA1320 - CA1321 - CA1152 - CA1154 € 50,00

**A100W** CA1320W - CA1321W - CA1152W - CA1154W € 50,00

Pianetto reggipiatto a scomparsa  
Rollaway dish holder surface  
Petit plateau porte assiette coulissant  
Kleine verschwindbare Fellerhalterplatte

### **Optionals**

**A200** CA1320 - CA1321 - CA1152 - CA1154 € 80,00

**A200W** CA1320W - CA1321W - CA1152W - CA1154W € 80,00

Cassetto portaposate a 3 scomparti  
3 buckets cutlery tray  
Panier à couverts à 3 compartiments  
Besteckkasten mit 3 Fächer

## Dolci, formaggi e antipasti - Cake, cheese and hors d'oeuvres trolley

## Chariot pour dessert, fromages et hors d'oeuvres - Kuchen, Käse und Vorspeisen Servierwagen



- 🇮🇹 Cupola in plx semicircolare con coperchi rientranti. Il carrello in foto è con accessori A 100 porta piatti e A 200 cassetto portapastate (optional).
- 🇬🇧 Semicircular plexiglas dome with re-entering covers. The trolley pictured includes accessories A100 plate holder and A200 cutlery tray (optional).
- 🇫🇷 Cloche en plexiglas semi-circulaire à couvercles rentrants. Le chariot illustré sur la photo est doté des accessoires A100 porte-assiettes et A200 tiroir à couverts (optional).
- 🇩🇪 Halbrunde Kuppel aus Plexiglas mit zurücktretenden Deckeln. Der Wagen auf dem Photo ist mit Zubehör A100, Tellerhalter, und A200, Besteckkasten (extra ausstattung).

**CA 1152** € 440,00

**CA 1152W** € 440,00

DIMENSIONI ESTERNE - EXTERNAL DIMENSIONS LxPxH cm  
DIMENSIONS EXTERIEURES - AUßENABMESSUNGEN LxPxH cm **90x57x112h**

**CA 1154** € 470,00

**CA 1154W** € 470,00

DIMENSIONI ESTERNE - EXTERNAL DIMENSIONS LxPxH cm  
DIMENSIONS EXTERIEURES - AUßENABMESSUNGEN LxPxH cm **110x57x112h**

**ATTENZIONE!** Le foto sono con OPTIONAL / **ATTENTION!** Photos shown on the catalogue are with OPTIONAL  
**ATTENTION!** Les photos sur le catalogue sont avec OPTIONAL / **ACHTUNG!** Die Photo auf dem Katalog sind EXTRAUSSTATTUNG



- 🇮🇹 Struttura in acciaio inox. Piani in acciaio inox stampati, satinati, insonorizzati. Ruote multidirezionali. Paracolpi in gomma. Cupola in plx semicircolare.
- 🇬🇧 Stainless steel structure. Glazed, soundproof and stainless steel shaped shelves. Multi-directional wheels. Rubber bumpers. Plexiglass semicircular cover.
- 🇫🇷 Structure en acier inox. Etagères en acier inox imprimées, satinées, insonorisées. Roues pivotantes. Butoirs en caoutchouc. Couvercle semi-circulaire en plexiglas.
- 🇩🇪 Struktur aus Edelstahl. Polierte, schalldichte, gedruckte Etagen aus Edelstahl. Multi-direktionale Rollen. Gummipuffer. Plexiglas halbkreisförmiger Deckel.

**CA 1390C** € 430,00

DIMENSIONI ESTERNE - EXTERNAL DIMENSIONS LxPxH cm  
DIMENSIONS EXTERIEURES - AUßENABMESSUNGEN LxPxH cm **92x59x108h**

**CA 1391C** € 460,00

DIMENSIONI ESTERNE - EXTERNAL DIMENSIONS LxPxH cm  
DIMENSIONS EXTERIEURES - AUßENABMESSUNGEN LxPxH cm **112x59x108h**



*Carrelli ed espositori refrigerati*  
*Carrelli, Tavole, Distributori Termici*  
*Carrelli termici con resistenza a secco*  
*Scalda tegamini / Scaldabiberon con resistenza a secco*  
*Carrelli termici bagnomaria*  
*Scalda tegamini - Scaldabiberon - Bagnomaria*  
*Carrello Termico Armadiato Bagnomaria*  
*Distributore per prime colazioni*



*Refrigerated trolleys and display cases*  
*Trolleys, Tables, Thermal distributors*  
*Thermal trolleys with dry heating element*  
*Pot warmers / Bottle warmers with dry heating element*  
*Thermal double boiler trolleys*  
*Pot warmers - Bottle warmers - Double boiler*  
*Thermal Double Boiler Trolley With Cabinet*  
*Breakfast distributor*



*Chariots et présentoirs réfrigérés*  
*Chariots, Tables, Distributeurs thermiques*  
*Chariots thermiques avec résistance à sec*  
*Chauffe-poêles / Chauffe-biberons avec résistance à sec*  
*Chariots thermiques bain-marie*  
*Chauffe-poêles - Chauffe-biberons - Bain-marie*  
*Chariot Thermique Bain-Marie Avec Armoire*  
*Distributeur pour petits-déjeuners*





*Wagen und gekühlter Ausstellungswagen*  
*Thermo, Wagen, Tische, Ausgabevorrichtungen*  
*Thermowagen mit trockenem thermoelement*  
*Topfwärmer / Milchfläschchenwärmer mit trockenem thermoelement*  
*Thermowagen für wasserbäder*  
*Topfwärmer - Milchfläschchenwärmer - Wasserbäder*  
*Thermo-Schrankwagen Für Wasserbäder*  
*Ausgabevorrichtung für frühstück*



## Vasche inox refrigerate da incasso - Built-in stainless steel refrigerated containers

## Cuves inox réfrigérés à emboîter - Gekülte Wannen aus rostfreiem Stahl um Zu Einlassen

 Struttura in acciaio inox AISI 304. Pannelli esterni in lamiera galvanizzata. Spessore isolamenti 50 mm. Refrigerazione statica. Gruppo incorporato nel vano inferiore, Controllo temperatura elettronico con termostato digitale. Sbrinatorio automatico, evaporazione dell'acqua di condensa automatico. Gas R314A 220/240V - 50Hz - 340W - 2,8KW/24 h.

 Stainless steel aisi 304 structure. External panels in galvanized sheet steel insulation thickness 50 mm static refrigeration. Gas unit incorporated in the lower space. Electronic temperature control with digital thermostat. Auto matic defrosting and automatic evaporation of condensation. Fas R 314 A 220/240 V - 50 Hz - 340 W - 2,8 Kw / 24 h.



 Structure en acier inox aisi 304 panneaux extérieurs en tôle galvanisée. Epaisseur d'isolation 50 mm. Réfrigération statique. groupe intégré dans lecompartiment inférieur. Contrôle électronique de la temperature avec thermostat digital. Dégivrage et evaporation de l'eau de condensation automatiques. Gas R 314 A 220/240 V - 50 Hz - 340 W - 2,8 Kw / 24 h.

 Gestell aus rostfreiem Stahl aisi 304. Externe Seitenpaneele aus galvanisiertem Blech. Isolirung 50 mm. Statische Kühlung. Gas gruppe im unterem Fach eingebaut. Elektronische Temperaturkontrolle mit digitalem thermostat. Automatische Evaporation des Kondenswassers. Gas R 314 A 220/240 V - 50 Hz - 340 W - 2,8 Kw / 24 h.

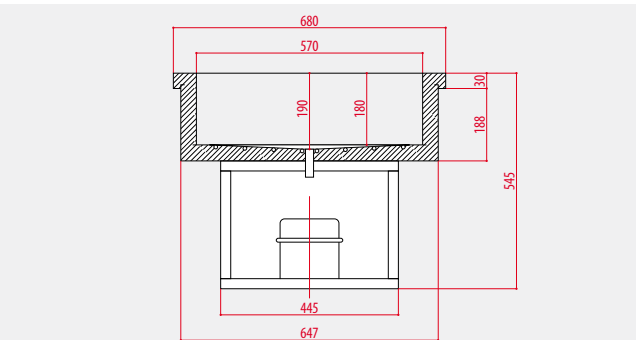
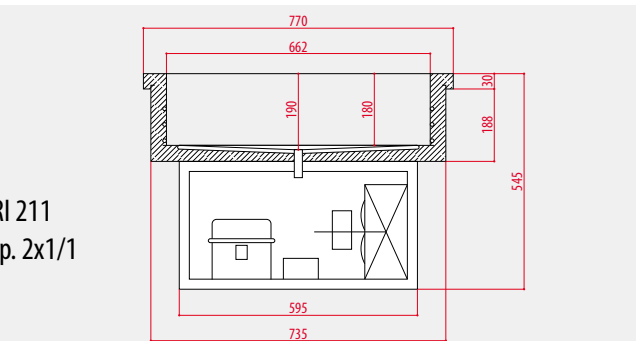
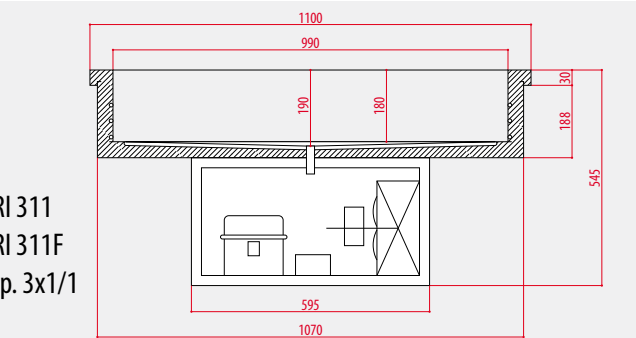
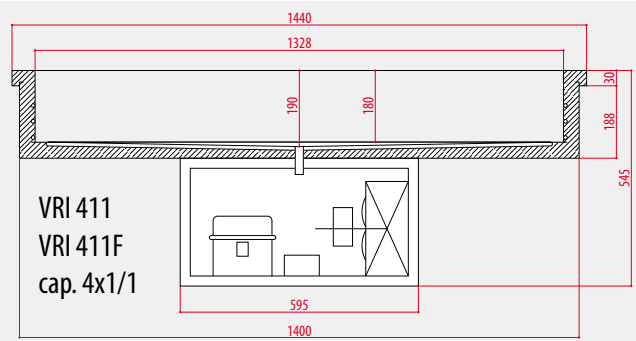

### VRI 211

€ 1.000,00

DIMENSIONI ESTERNE - EXTERNAL DIMENSIONS LxPxH cm  
DIMENSIONS EXTERIEURES - AUBENABMESSUNGEN LxPxH cm

**Vasca 2x1/1 GN**  
**150 h (+2° +8°C)**

### VRI 311

€ 1.100,00

DIMENSIONI ESTERNE - EXTERNAL DIMENSIONS LxPxH cm  
DIMENSIONS EXTERIEURES - AUBENABMESSUNGEN LxPxH cm

**Vasca 3x1/1 GN**  
**150 h (+2° +8°C)**

### VRI 411

€ 1.160,00

DIMENSIONI ESTERNE - EXTERNAL DIMENSIONS LxPxH cm  
DIMENSIONS EXTERIEURES - AUBENABMESSUNGEN LxPxH cm

**Vasca 4x1/1 GN**  
**150 h (+2° +8°C)**

### VRI 311F

€ 1.360,00

DIMENSIONI ESTERNE - EXTERNAL DIMENSIONS LxPxH cm  
DIMENSIONS EXTERIEURES - AUBENABMESSUNGEN LxPxH cm

**Vasca 3x1/1 GN**  
**150 h (-5° +5°C)**





### VRI 411F

€ 1.490,00

DIMENSIONI ESTERNE - EXTERNAL DIMENSIONS LxPxH cm  
DIMENSIONS EXTERIEURES - AUBENABMESSUNGEN LxPxH cm

**Vasca 4x1/1 GN**  
**150 h (-5° +5°C)**

## Vasche inox bagnaroma da incasso - Stainless steel built-in bain-marie tanks Cuves inox bain-marie à emboîter - Einbaubecken aus rostfreiem Stahl für Bain-Marie

-  Vasca in acciaio inox per contenitori gastronorm 1/1 munita di scarico, centralina controllo temperatura da +30° a +90°C 230V 50/60 Hz, resistenza da 2000W, pannello porta centralina, cavi elettrici.
-  Stainless steel tank for 1/1 gastronorm containers with drain, temperature control unit from +30° to +90°C 230V 50/60 Hz, resistance 2000W, control unit panel, electrical cables.
-  Cuve en acier inoxydable pour les bacs GN 1/1 avec vidange, platine de contrôle de la température de +30° à +90°C 230V 50/60 Hz, résistance 2000W, panneau pour platine, câbles électriques.
-  Einbaubecken aus rostfreiem Stahl für GN 1/1 Behälter mit Auslass, mit Temperaureinheit von +30° bis +90°C 230V 50/60 Hz mit 2000W Widerstand, Platte für Steuereinheit, elektrische Kabel.



**VBC 211**

**€ 600,00**

DIMENSIONI ESTERNE - EXTERNAL DIMENSIONS LxPxH cm  
DIMENSIONS EXTERIEURES - AUBENABMESSUNGEN LxPxH cm

**Vasca 2x1/1 GN**  
**150 h (+30° +90°C)**

**VBC 311**

**€ 650,00**

DIMENSIONI ESTERNE - EXTERNAL DIMENSIONS LxPxH cm  
DIMENSIONS EXTERIEURES - AUBENABMESSUNGEN LxPxH cm

**Vasca 3x1/1 GN**  
**150 h (+30° +90°C)**

**VBC 411**

**€ 700,00**

DIMENSIONI ESTERNE - EXTERNAL DIMENSIONS LxPxH cm  
DIMENSIONS EXTERIEURES - AUBENABMESSUNGEN LxPxH cm

**Vasca 4x1/1 GN**  
**150 h (+30° +90°C)**

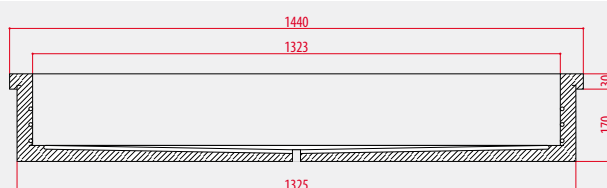

VBC 411 - cap. 4x1/1

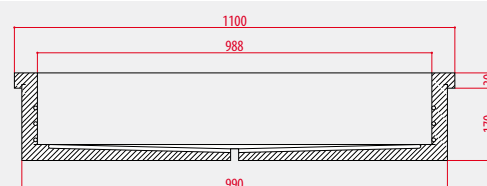

VBC 311 - cap. 3x1/1

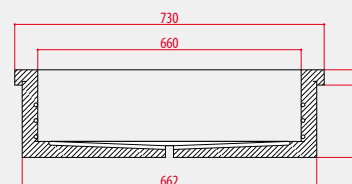

VRI 211 - cap. 2x1/1

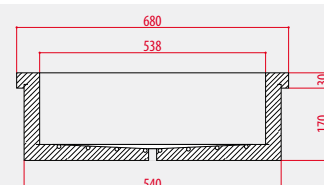



VISTA LATERALE

## Carrelli ed espositori refrigerati - Refrigerated trolleys and display cases

## Chariots et présentoirs réfrigérés - Wagen und gekühlter Ausstellungswagen

 **CARRELLO REFRIGERATO.** Struttura interamente in acciaio inox Temperatura +2° +10°C Capacità n° 3 x GN 1/1 h. 150 Alimentazione 230V/1N/50Hz 250W Gas refrigerante R134A (bacinelle escluse).

 **REFRIGERATED TROLLEY.** Stainless steel frame Temperature +2° +10°C Capacity nos. 3 x GN 1/1 h. 150 Power 230V/1N/50Hz 250W Refrigerant R134A (containers not included).

 **CHARIOT RÉFRIGÉRÉ.** Structure en acier inox Température +2° +10°C Capacité nos. 3 x GN 1/1 h. 150 Alimentation 230V/1N/50Hz 250W Gaz réfrigérant R134A (bacs exclus).

 **KÜHLWAGEN.** Aufbau aus Edelstahl Temperatur +2° +10°C Kapazität 3 x GN 1/1 h. 150 Beschickung 230V/1N/50Hz 250W Kühlgas R134A (Schüsseln Ausgenommen).



**CAR 2780 (+2° +10°C)**

**€ 2.480,00**

**CAR 2780BT (-5° +5°C)**

**€ 2.650,00**

DIMENSIONI ESTERNE LxPxH cm  
EXTERNAL DIMENSIONS LxPxH cm  
DIMENSIONS EXTERIEURES LxPxH cm  
AUBENABMESSUNGEN LxPxH cm

**124x72x126 h**

**CAR 2779 (+2° +10°C)**

**€ 2.150,00**

DIMENSIONI ESTERNE LxPxH cm  
EXTERNAL DIMENSIONS LxPxH cm  
DIMENSIONS EXTERIEURES LxPxH cm  
AUBENABMESSUNGEN LxPxH cm

**124x72x94 h**

- 🇮🇹 **CARRELLI TERMICI CON RESISTENZA A SECCO** (senza acqua). Struttura in acciaio inox. Vasca a doppia parete. Termostato regolabile 30°-90°C, alimentazione V230 50/60 Hz. Interruttore accensione con spia luminosa, spia luminosa di riscaldamento in atto. Ruote piroettanti paracolpi e maniglia direzionale (bacinelle escluse).
- 🇬🇧 **THERMAL TROLLEYS WITH DRY HEATING ELEMENT** (without water). Stainless steel structure. Double layer basin. Adjustable thermostat 30°-90°C. Mains supply: 230 V 50/60 Hz. Switch with warning light to indicate the heat is on. Multidirectional wheels. Buffers and pushing handle (containers not included).
- 🇫🇷 **CHARIOTS THERMIQUES AVEC RESISTANCE À SEC** (sans eau). Structure en acier inox. Cuve à double paroi. Thermostat réglable 30°-90°C. Alimentation 230 V 50/60 Hz. Interrupteur d'allumage avec lampe témoin, voyant de chauffage en état de marche. Roues pivotantes. Butoirs et poignée de direction (bacs exclus).
- 🇩🇪 **THERMOWAGEN MIT TROCKEM THERMOELEMENT** (ohne Wasser). Gestell aus rostfreiem Stahl. Becken mit doppelten Wänden. Regulierbares Thermostat: 30°-90°C, Beschickung: 230 V 50/60 Hz. Einschalter mit Kontrolllampe. Aufwärm-Kontrolllampe. Pirouettierende Rollen. Puffer und Handgriff (Schüsseln Ausgenommen).

- 🇮🇹 **SCALDA TEGAMINI / SCALDA BIBERON CON RESISTENZA A SECCO** (senza acqua). Struttura in acciaio inox. Vasca a doppia parete. Termostato regolabile 30°-90°C, alimentazione V230 50/60 Hz. Interruttore accensione con spia luminosa, spia luminosa di riscaldamento in atto. Ruote piroettanti paracolpi e maniglia direzionale (bacinelle escluse).
- 🇬🇧 **POT WARMES / BOTTLE WARMES WITH DRY HEATING ELEMENT** (without water). Sstainless steel structure. Double layer basin. Adjustable thermostat 30°-90°C. Main supply: 230V 50/60 Hz. Switch with warning light to indicate the heat is on. Multidirectional wheels. Buffers and pushing handle (containers not included).
- 🇫🇷 **CHAUFFE-POÊLES / CHAUFFE-BIBERONS AVEC RÉSISTANCE À SEC** (sans eau). Structure en acier inoxydable. Cuve à double paroi. Thermostat réglable 30°-90°C. Alimentation 230V 50/60 Hz. Interrupteur d'allumage avec lampe témoin, voyant de chauffage en état de marche. Roues pivotantes. Butoirs et poignée de direction (bacs exclus).
- 🇩🇪 **TOPFWÄRMER / MILCHFLÄSCHCHENWÄRMER MIT TROCKEM THERMOELEMENT** (ohne Wasser). Gestell aus rostfreiem Stahl. Becken mit doppelten Wänden. Regulierbares Thermostat: 30°-90°C, Beschickung: 230V 50/60 Hz. Einschalter mit Kontrolllampe. Aufwärm-Kontrolllampe. Pirouettierende Rollen. Puffer und Handgriff (Schüsseln Ausgenommen).



**CTS 1757 (1x1/1GN)**

**€ 650,00**

DIMENSIONI ESTERNE LxPxH cm  
 EXTERNAL DIMENSIONS LxPxH cm  
 DIMENSIONS EXTERIEURES LxPxH cm  
 AUßENABMESSUNGEN LxPxH cm

**56x65x85h**  
**1x1/1 GN 200h**  
**1000 W**



**CSS 1750 (1x1/1GN)**

**€ 730,00**

DIMENSIONI ESTERNE LxPxH cm  
 EXTERNAL DIMENSIONS LxPxH cm  
 DIMENSIONS EXTERIEURES LxPxH cm  
 AUßENABMESSUNGEN LxPxH cm

**56x65x85h**  
**1x1/1 GN**  
**1000 W**

**CTS 1759 (2x1/1GN)**

**€ 750,00**

DIMENSIONI ESTERNE LxPxH cm  
 EXTERNAL DIMENSIONS LxPxH cm  
 DIMENSIONS EXTERIEURES LxPxH cm  
 AUßENABMESSUNGEN LxPxH cm

**84x65x85h**  
**2x1/1 GN 200h**  
**1000 W**

**CSS 1752 (2x1/1GN)**

**€ 880,00**

DIMENSIONI ESTERNE LxPxH cm  
 EXTERNAL DIMENSIONS LxPxH cm  
 DIMENSIONS EXTERIEURES LxPxH cm  
 AUßENABMESSUNGEN LxPxH cm

**84x65x85h**  
**2x1/1 GN**  
**1000 W**

**CTS 1761 (3x1/1GN)**

**€ 850,00**

DIMENSIONI ESTERNE LxPxH cm  
 EXTERNAL DIMENSIONS LxPxH cm  
 DIMENSIONS EXTERIEURES LxPxH cm  
 AUßENABMESSUNGEN LxPxH cm

**117x65x85h**  
**3x1/1 GN 200h**  
**2000 W**

**CSS 1754 (3x1/1GN)**

**€ 960,00**

DIMENSIONI ESTERNE LxPxH cm  
 EXTERNAL DIMENSIONS LxPxH cm  
 DIMENSIONS EXTERIEURES LxPxH cm  
 AUßENABMESSUNGEN LxPxH cm

**117x65x85h**  
**3x1/1 GN**  
**2000 W**

## Carrelli termici bagnomaria - Thermal double boiler trolleys

### Chariots thermiques bain-marie - Thermowagen für wasserbäder

- CARRELLI TERMICI BAGNOMARIA.** Struttura in acciaio inox. Vasca a doppia parete provvista di rubinetto di scarico posto sul fondo. Termostato regolabile 30°-90°C. Alimentazione W2000 V230 50/60 Hz. Interruttore accensione con spia luminosa, spia luminosa di riscaldamento in atto. Termostato limite. Ruote piroettanti paracolpi e maniglia direzionale (bacinelle escluse).
- THERMAL DOUBLE BOILER TROLLEYS.** Stainless steel structure. Double layer basin. Bottom equipped with drain on the bottom tap. 30°-90°C, adjustable thermostat. Main supply: W2000 230V 50/60 Hz. Switch with warning light to indicate the heat is on. Thermostat limit. Multidirectional wheels. Buffers and pushing handle (containers not included).
- CHARIOTS THERMIQUES BAIN-MARIE.** Structure en acier inox. Cuve à double paroi équipée de tuyau de vidange sur le fond. Thermostat réglable 30°-90°C. Alimentation W2000 230V 50/60 Hz. Interrupteur d'allumage avec lampe témoin, voyant de chauffage en état de marche. Thermostat limite. Roues pivotantes. Butoirs et poignée de direction (bacs exclus).
- THERMOWAGEN FÜR WASSERBÄDER.** Gestell aus rostfreiem Stahl. Becken mit doppelten Wänden mit Ablasshahn am Boden. Regulierbares Thermostat: 30°-90°C, Beschickung: W2000 230V 50/60 Hz. Einschalter mit Kontrolllampe, Aufwärm-Kontrolllampe. Beschränkenden Thermostat. Pirouettierende Rollen. Puffer und Handgriff (Schüsseln Ausgenommen).



**CT 1756 (1x1/1 GN) € 640,00**

DIMENSIONI ESTERNE LxPxH cm - EXTERNAL DIMENSIONS LxPxH cm **56x65x85h**  
DIMENSIONS EXTERIEURES LxPxH cm - AUßENABMESSUNGEN LxPxH cm **1x1/1 GN 200h**

**CT 1758 (2x1/1 GN) € 740,00**

DIMENSIONI ESTERNE LxPxH cm - EXTERNAL DIMENSIONS LxPxH cm **84x65x85h**  
DIMENSIONS EXTERIEURES LxPxH cm - AUßENABMESSUNGEN LxPxH cm **2x1/1 GN 200h**

**CT 1760 (3x1/1 GN) € 800,00**

DIMENSIONI ESTERNE LxPxH cm - EXTERNAL DIMENSIONS LxPxH cm **117x65x85h**  
DIMENSIONS EXTERIEURES LxPxH cm - AUßENABMESSUNGEN LxPxH cm **3x1/1 GN 200h**

**CT 1762 (4x1/1 GN) € 950,00**

DIMENSIONI ESTERNE LxPxH cm - EXTERNAL DIMENSIONS LxPxH cm **148x65x85h**  
DIMENSIONS EXTERIEURES LxPxH cm - AUßENABMESSUNGEN LxPxH cm **4x1/1 GN 200h**

- SCALDA TEGAMINI - SCALDA BIBERON - BAGNOMARIA.** Struttura in acciaio inox. Vasca a doppia parete provvista di rubinetto di scarico posto sul fondo. Termostato regolabile 30°-90°C, alimentazione W2000 V230 50/60 Hz. Interruttore accensione con spia luminosa, spia luminosa di riscaldamento in atto. Termostato limite. Ruote piroettanti paracolpi e maniglia direzionale (bacinelle escluse).
- POT WARMERS - BOTTLE WARMERS - DOUBLE BOILER.** Stainless steel structure. Double layer basin. Equipped with drain on the bottom tap. 30°-90°C adjustable thermostat. Main supply: W2000 230V 50/60 Hz. Switch with warning light to indicate the heat is on. Thermostat limit. Multidirectional wheels. Buffers and pushing handle (containers not included).
- CHAUFFE-POÊLES - CHAUFFE-BIBERONS - BAIN-MARIE.** Structure en acier inoxydable. Cuve à double paroi équipée de tuyau de vidange sur le fond. Thermostat réglable 30°-90°C, alimentation W2000 230V 50/60 Hz, Interrupteur d'allumage avec lampe témoin, voyant de chauffage en état de marche. Thermostat limite. Roues pivotantes. Butoirs et poignée de direction (bacs exclus).
- TOPFWÄRMER - MILCHFLÄSCHENWÄRMER - WASSERBÄDER.** Gestell aus rostfreiem Stahl. Becken mit doppelten Wänden mit Ablasshahn am Boden. Regulierbares Thermostat: 30°-90°C, beschickung: W2000 230V 50/60 Hz W. Einschalter mit Kontrolllampe. Beschränkenden Thermostat. Aufwärm-Kontrolllampe. Pirouettierende Rollen. Puffer und Handgriff (Schüsseln Ausgenommen).



**CS 1751 (1x1/1 GN) € 720,00**

DIMENSIONI ESTERNE LxPxH cm - EXTERNAL DIMENSIONS LxPxH cm **56x65x85h**  
DIMENSIONS EXTERIEURES LxPxH cm - AUßENABMESSUNGEN LxPxH cm **1x1/1 GN 200h**

**CS 1753 (2x1/1 GN) € 840,00**

DIMENSIONI ESTERNE LxPxH cm - EXTERNAL DIMENSIONS LxPxH cm **84x65x85h**  
DIMENSIONS EXTERIEURES LxPxH cm - AUßENABMESSUNGEN LxPxH cm **2x1/1 GN 200h**

**CS 1755 (3x1/1 GN) € 900,00**

DIMENSIONI ESTERNE LxPxH cm - EXTERNAL DIMENSIONS LxPxH cm **117x65x85h**  
DIMENSIONS EXTERIEURES LxPxH cm - AUßENABMESSUNGEN LxPxH cm **3x1/1 GN 200h**

## **Carrelli termici bagnomaria - Thermal double boiler trolleys** **Chariots thermiques bain-marie - Thermowagen für wasserbäder**

 **CARRELLI TERMICI BAGNOMARIA CON TEMPERATURA DIFFERENZIATA.** Struttura in acciaio inox. Vasca a doppia parete provvista di rubinetto di scarico posto sul fondo. Termostato regolabile 30°-90°C. Alimentazione W2000 V230 50/60 Hz. Interruttore accensione con spia luminosa, spia luminosa di riscaldamento in atto. Termostato limite. Ruote piroettanti paracolpi e maniglia direzionale (bacinelle escluse).

 **THERMAL DOUBLE BOILER TROLLEYS WITH DIFFERENTIATED TEMPERATURES.** Stainless steel structure. Double layer basin. Bottom equipped with drain on the bottom tap. 30°-90°C, adjustable thermostat. Main supply: W2000 230V 50/60 Hz. Switch with warning light to indicate the heat is on. Thermostat limit. Multidirectional wheels. Buffers and pushing handle (containers not included).

 **CHARIOTS THERMIQUES BAIN-MARIE AVEC TEMPERATURES DIFFERENCIÉES.** Structure en acier inox. Cuve à double paroi équipée de toyant de vidange sur le fond. Thermostat réglable 30°-90°C. Alimentation W2000 230V 50/60 Hz. Interrupteur d'allumage avec lampe témoin, voyant de chauffage en état de marche. Thermostat limite. Roues pivotantes. Butoirs et poignée de direction (bacs exclus).

 **THERMOWAGEN FÜR WASSERBÄDER MIT VERSCHIEDENEN TEMPERATUREN.** Gestell aus rostfreiem Stahl. Becken mit doppelten Wänden mit Ablasshahn am Boden. Regulierbares Thermostat: 30°-90°C, Beschickung: W2000 230V 50/60 Hz. Einschalter mit Kontrolllampe, Aufwärm-Kontrolllampe. Beschränkenden Thermostat. Pirouettierende Rollen. Puffer und Handgriff (Schüsseln Ausgenommen).



**CT 1758TD (2x1/1 GN)**

**€ 820,00**

DIMENSIONI ESTERNE LxPxH cm  
EXTERNAL DIMENSIONS LxPxH cm  
DIMENSIONS EXTERIEURES LxPxH cm  
AUBENABMESSUNGEN LxPxH cm

**84x65x85h**  
**N° 2x1/1 GN 150h**  
**2000 W**

**CT 1760TD (3x1/1 GN)**

**€ 1.050,00**

DIMENSIONI ESTERNE LxPxH cm  
EXTERNAL DIMENSIONS LxPxH cm  
DIMENSIONS EXTERIEURES LxPxH cm  
AUBENABMESSUNGEN LxPxH cm

**117x67x85h**  
**N° 3x1/1 GN 150h**  
**3000 W**



**CARRELLI TERMICI BAGNOMARIA CON CUPOLA SEMICIRCOLARE**  
**THERMAL BAIN-MARIE TROLLEYS WITH SEMICIRCULAR CAP**  
**CHARIOTS BAIN-MARIE THERMIQUES AVEC DÔME SEMI-CIRCULAIRE**  
**BAIN-MARIE THERMOWAGEN MIT HALBKREISFÖRMIGEM DECKEL**

**CT 1760C (3x1/1 GN)**

**€ 1.120,00**

DIMENSIONI ESTERNE LxPxH cm  
EXTERNAL DIMENSIONS LxPxH cm  
DIMENSIONS EXTERIEURES LxPxH cm  
AUBENABMESSUNGEN LxPxH cm

**117x67x114h**  
**N° 3x1/1 GN 200h**  
**2000 W**

## Carrelli termici bagnomaria - Thermal double boiler trolleys

### Chariots thermiques bain-marie - Thermowagen für wasserbäder

**🇮🇹 CARRELLO TERMICO ARMADIATO BAGNOMARIA.** Interamente costruito in acciaio inox AISI 304 18/10. Il vano superiore, in doppia parete coibentata, è dotato di rubinetto di scarico sul fondo. Il carrello è atto a contenere bacinelle GN fino ad una profondità di cm 20. Il vano inferiore è chiuso da antine. I coperchi sono apribili a compasso fino a 180° per formare un comodo piano di appoggio. Riscaldamento a bagnomaria mediante resistenza elettrica. 4 ruote di cui 2 piroettanti con freno 2 fisse (bacinelle escluse).

**🇬🇧 THERMAL DOUBLE BOILER TROLLEY WITH CABINET.** Made entirely in 18/10 AISI. 304 stainless steel. The upper compartment with double insulated walls has a drain tap at the bottom. The trolley is designed to hold GN containers up to a depth of 20 cm. The lower cupboard is closed with doors. The hinged covers can be opened to 180° to form a convenient support surface. Water-bath heating with electrical element. 4 wheels of which 2 multidirectional with brake and 2 fixed (containers excluded).

**🇫🇷 CHARIOT THERMIQUE BAIN-MARIE AVEC ARMOIRE.** Chariot en acier inox AISI 304 18/10. Le compartiment supérieur, à double paroi isothermique, est doté d'un robinet pour l'évacuation sur le fond. Le chariot peut contenir des cuvettes GN d'une profondeur maximale de 20 cm. Le compartiment inférieur est fermé par des portes. Les couvercles du compartiment supérieur s'ouvrent à 180° formant un plan d'appui très pratique. Chauffage à bain-marie au moyen d'une résistance électrique. 4 roues dont 2 pivotantes avec frein et 2 fixes (conteneurs exclus).

**🇩🇪 THERMO-SCHRANKWAGEN FÜR WASSERBÄDER.** Thermo-Schrankwagen. Innen aus rostfreiem Stahl AISI 304 18/10. Der obere Raum besitzt eine doppelte Dämmwand und einen Auslaßhahn am Boden. Der Wagen eignet sich für die Aufnahme von Gastronorm-Schalen bis zu einer Tiefe von 20 cm. Der untere Raum ist durch Flügel geschlossen. Die Deckel gehen im Winkel bis 180° auf und bilden so eine bequeme Abstellfläche. Wasserbad-Erwärmung durch elektrischen Widerstand. 4 Räder, 2 davon leichtlaufende mit Bremse und 2 feste (Behälter ausgeschlossen).



#### **CT 1766 (2x1/1 GN)**

**€ 1.650,00**

DIMENSIONI ESTERNE LxPxH cm  
EXTERNAL DIMENSIONS LxPxH cm  
DIMENSIONS EXTERIEURES LxPxH cm  
AUBENABMESSUNGEN LxPxH cm

**96x68x92h**  
**2x1/1 GN 200h**  
**230V 50/60 Hz**  
**2400 W**

#### **CT 1771 (3x 1/1 GN)**

**€ 1.950,00**

DIMENSIONI ESTERNE LxPxH cm  
EXTERNAL DIMENSIONS LxPxH cm  
DIMENSIONS EXTERIEURES LxPxH cm  
AUBENABMESSUNGEN LxPxH cm

**130x68x92h**  
**3x1/1 GN 200h**  
**230V 50/60 Hz**  
**2400 W**

### **Optionals**

#### **A700**

Vano inferiore riscaldato (W.600) - Lower compartment heated - Compartiment inferieur chauffé - Erwärmter Unterer Raum

**€ 166,00**



## Carrelli termici bagnomaria - Thermal double boiler trolleys Chariots thermiques bain-marie - Thermowagen für wasserbäder



### CT 1765 (2x1/1 GN)

€ 2.150,00

DIMENSIONI ESTERNE LxPxH cm  
EXTERNAL DIMENSIONS LxPxH cm  
DIMENSIONS EXTERIEURES LxPxH cm  
AUBENABMESSUNGEN LxPxH cm

96x68x102h  
2x1/1 GN 200h  
230V 50/60 Hz  
2400 W

### CT 1770 (3x1/1 GN)

€ 2.450,00

DIMENSIONI ESTERNE LxPxH cm  
EXTERNAL DIMENSIONS LxPxH cm  
DIMENSIONS EXTERIEURES LxPxH cm  
AUBENABMESSUNGEN LxPxH cm

130x68x102h  
3x1/1 GN 200h  
230V 50/60 Hz  
2400 W



CARRELLI TERMICI BAGNOMARIA CON TEMPERATURA DIFFERENZIATA  
THERMAL DOUBLE BOILER TROLLEYS WITH DIFFERENTIATED TEMPERATURES  
CHARIOTS THERMIQUES BAIN-MARIE AVEC TEMPERATURES DIFFERENCIEES  
THERMOWAGEN FÜR WASSERBÄDER MIT VERSCHIEDENEN TEMPERATUREN

### CT 1766 TD (2x1/1 GN)

€ 1.800,00

DIMENSIONI ESTERNE LxPxH cm  
EXTERNAL DIMENSIONS LxPxH cm  
DIMENSIONS EXTERIEURES LxPxH cm  
AUBENABMESSUNGEN LxPxH cm

96x68x92h  
2x1/1 GN 200h  
230V 50/60 Hz  
2400 W

### CT 1771 TD (3x1/1 GN)

€ 2.250,00

DIMENSIONI ESTERNE LxPxH cm  
EXTERNAL DIMENSIONS LxPxH cm  
DIMENSIONS EXTERIEURES LxPxH cm  
AUBENABMESSUNGEN LxPxH cm

130x68x92h  
3x1/1 GN 200h  
230V 50/60 Hz  
W 2400

### Optionals

#### A700

Vano inferiore riscaldato (W.600) - Lower compartment heated - Compartiment inferieur chauffé - Erwärmter Unterer Raum

€ 166,00

**Carrelli termici bagnomaria - Thermal double boiler trolleys**  
**Chariots thermiques bain-marie - Thermowagen für wasserbäder**



**CT 1765 TD (2x1/1 GN)**

**€ 2.250,00**

DIMENSIONI ESTERNE LxPxH cm  
 EXTERNAL DIMENSIONS LxPxH cm  
 DIMENSIONS EXTERIEURES LxPxH cm  
 AUBENABMESSUNGEN LxPxH cm

**96x68x102h**  
**2x1/1 GN 200h**  
**230V 50/60 Hz**  
**2400 W**

**CT 1770 TD (3x1/1 GN)**

**€ 2.600,00**

DIMENSIONI ESTERNE LxPxH cm  
 EXTERNAL DIMENSIONS LxPxH cm  
 DIMENSIONS EXTERIEURES LxPxH cm  
 AUBENABMESSUNGEN LxPxH cm

**130x68x102h**  
**3x1/1 GN 200h**  
**230V 50/60 Hz**  
**2400 W**





DIMENSIONI ESTERNE LxPxH cm  
 EXTERNAL DIMENSIONS LxPxH cm  
 DIMENSIONS EXTERIEURES LxPxH cm  
 AUBENABMESSUNGEN LxPxH cm

**170x68x102h mod. (2x1/1 GN)**  
**237x68x102h mod. (3x1/1 GN)**



## Carrelli termici bagnomaria - Thermal double boiler trolleys Chariots thermiques bain-marie - Thermowagen für wasserbäder

 **DISTRIBUTORE PER PRIME COLAZIONI.** Distributore interamente in acciaio inox AISI 304 18/10 con vasca doppia parete. Pentole in acciaio inox AISI 304 18/10 da lt 15 cad. complete di coperchio. Rubinetti in plastica facilmente smontabili per la pulizia quotidiana. Riscaldamento mediante resistenza elettrica a bagno-maria W 2000, V230 50/60 Hz regolata da termostato 30°- 90°C e controllata da spia luminosa. Mobiletto di sostegno in acciaio inox, chiuso da ante a battente e provvisto di ripiano intermedio. Ruote piroettanti.

 **BREAKFAST DISTRIBUTOR.** Distributor AISI 304 18/10 stainless steel framework with double wall basin. Stainless steel tanks AISI 304 18/10 of 15 Lt. each, with cover. Plastic taps easy to dismount for cleaning. Bain-marie method-electric immersion heater W 2000, V230 50/60 Hz regulated by means of thermostat 30° 90°C with warning light. Supporting framework in stainless steel, doors and intermediate shelf. Swivelling wheels.

 **DISTRIBUTEUR POUR PETITS-DÉJEUNERS.** Distributeur en acier inox AISI 304 18/10 avec cuve à double paroi. Conteniteurs en acier inox AISI 304 18/10 de 15 Lt. chacun avec couvercle. Robinets en plastique faciles à démonter pour le nettoyage. Chauffage à bain-marie au moyen d'une résistance bndée W 2000, V230 50/60 Hz. Equipé de thermostat 30°- 90°C et lampe témoin. Meuble en acier inox fermé par des antes à battent et pourvu d'une étagère intermediaire. Roues pivotantes.

 **AUSGABEVORRICHTUNG FÜR FRÜHSTÜCK.** Frühstückswagen aus rostfreiem Stahl AISI 304 18/10. Becken mit doppelten Wänden. Töpfe aus Rostfreiem Stahl AISI 304 18/10 zu jeweils 15 Lt. mit Deckel. Für die tägliche Reinigung leicht demontierbare Zapfhähne aus Kunststoff. Erwärmung durch elektrischen Widerstand im Wasserbad 2000, W, V230 50/60 Hz; wird durch Thermostat von 30°- 90°C reguliert und durch Kontrolllampe angezeigt. Zusatzschrankchen aus Edelstahl mit Türklopper und Zwischen-Etage. Pirouettierende Rollen.



### DCM 1699

€ 2.300,00

DIMENSIONI ESTERNE LxPxH cm  
EXTERNAL DIMENSIONS LxPxH cm  
DIMENSIONS EXTERIEURES LxPxH cm  
AUBENABMESSUNGEN LxPxH cm

**75x41x135h**

2 recipienti da lt 15 - 2 urns lt. 15  
2 bacs de 15 lt - 2 Kannen zu 15 lt

### DCM 1701

€ 2.900,00

DIMENSIONI ESTERNE LxPxH cm  
EXTERNAL DIMENSIONS LxPxH cm  
DIMENSIONS EXTERIEURES LxPxH cm  
AUBENABMESSUNGEN LxPxH cm

**106x41x135h**

3 recipienti da lt 15 - 3 urns lt. 15  
3 bacs de 15 lt - 3 Kannen zu 15 lt

Da appoggio. Vasca recupero liquidi. Caratteristiche come art. DC 1699-1701 senza mobile.

Table appliance. Liquid collection basin. Characteristics as for DC 1699-1701, without unit.

Appareil de table. Cuve de récupération des liquides. Caractéristiques identiques à DC 1699-1701, sans meuble.

Tischgeraet - Flüssigkeitsauffangschale. Eigenschaften wie DC 1699-1701 ohne Möbel.

### DC 1704

€ 1.680,00

DIMENSIONI ESTERNE LxPxH cm  
EXTERNAL DIMENSIONS LxPxH cm  
DIMENSIONS EXTERIEURES LxPxH cm  
AUBENABMESSUNGEN LxPxH cm

**75x41x71h**

2 recipienti da lt 15 - 2 contains 15 lt  
2 bacs de 15 lt - 2 Kannen 15 Lt

### DC 1703

€ 2.150,00

DIMENSIONI ESTERNE LxPxH cm  
EXTERNAL DIMENSIONS LxPxH cm  
DIMENSIONS EXTERIEURES LxPxH cm  
AUBENABMESSUNGEN LxPxH cm

**106x41x71h**

3 recipienti da lt 15 - 3 containers 15 lt  
3 bacs de 15 lt - 3 Kannen 15 Lt



***Carrelli ed espositori refrigerati in legno***   
***Espositore caldo bagnomaria con cupola***  
***Bolliti e arrosti***

***Refrigerated wooden trolleys and display cases***   
***Bain-marie warmed display case with dome***  
***Roast and boiled meat trolley***

***Chariots et présentoirs réfrigérés en bois***   
***Présentoir chauffé bain-marie avec cloche***  
***Chariot pour bouillis et rotis***

***Wagen und gekühlter Ausstellungswagen aus Holz***   
***Warme wasserbadausstellung mit kuppel***  
***Wagen für Kochfleisch und Braten***

## Carrelli ed espositori refrigerati - Refrigerated trolleys and display cases

## Chariots et présentoirs réfrigérés - Wagen und gekühlter Ausstellungswagen

 **CARRELLO REFRIGERATO IN LEGNO CON CUPOLA IN PLEXIGLASS.** Struttura in legno massello. Cupola in plexiglass. Refrigerazione statica. Temperatura da +2° +10°C con coperchi posizionati. Voltaggio 230 V 50 Hz. Gas refrigerante: R 134 A. Capacità n. 3 gastronorm 1/1 h 150. Dotato di 2 mensole d'appoggio pieghevoli (bacinelle escluse).

 **WOODEN REFRIGERATED CARTS WITH PLEXIGLAS DOMES.** Solid wood frame. Plexiglass cover. Static refrigeration. Temperature between +2° +10°C when covers are positioned. 230 V 50 Hz. Refrigerant: R134A. Capacity: 3 GN 1/1 H. 150. Equipped with two folding shelves (containers not included).

 **CHARIOT RÉFRIGÉRÉ EN BOIS AVEC CLOCHE EN PLEXIGLAS.** Structure en bois massif, couvercle en plexiglass. Réfrigération statique. Température de +2° +10°C avec les couvercles en position. Voltagge 230V 50 Hz. Gaz réfrigérant: R134 A. Capacité 3 GN 1/1 h 150. Equipé de 2 étagères pliables (bacs exclus).

 **KÜHLWAGEN AUS MASSIVEM HOLZ MIT PLEXIGLAS-ABDECKUNG.** Aufbau aus massivem Holz, Abdeckung aus Plexiglas. Statische Kühlung. Temperatur von 2°C bis 10°C (bei geschlossener Abdeckung). Versorgungsspannung 230 V, 50 Hz. Kühlgas: R134A. Kapazität 3 GN 1/1 h 150. Kapazität 3 GN 1/1 h 150. Mit 2 Klappbaren Stützkonsolen ausgestattet (Schüsseln Ausgenommen).



**CLR 2788 (+2° +10°C) € 2.750,00**

**CLR 2788BT (-5° +5°C) € 3.000,00**

**(Gastronorm 3x1/1 - h 150)**

**CLR 2788W (+2° +10°C) € 2.750,00**

**CLR 2788BTW (-5° +5°C) € 3.000,00**

**(Gastronorm 3x1/1 - h 150)**

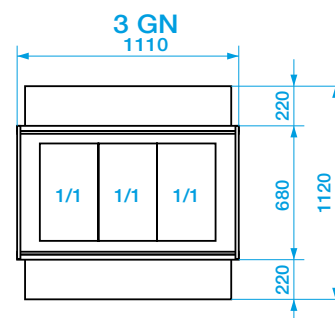
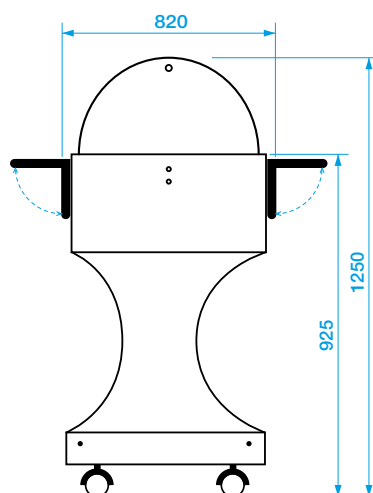

**Carrelli ed espositori refrigerati - Refrigerated trolleys and display cases**  
**Chariots et présentoirs réfrigérés - Wagen und gekühlter Ausstellungswagen**



**CLR 2787 (+2° +10°C) € 2.750,00**

**CLR 2787BT (-5° +5°C) € 3.000,00**

**(Gastronorm 3x1/1 - h 150)**



**CLR 2787W (+2° +10°C) € 2.750,00**

**CLR 2787BTW (-5° +5°C) € 3.000,00**

**(Gastronorm 3x1/1 - h 150)**

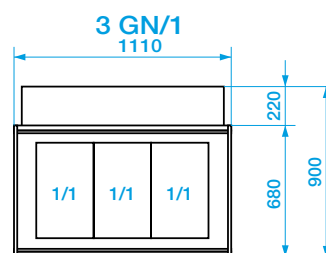
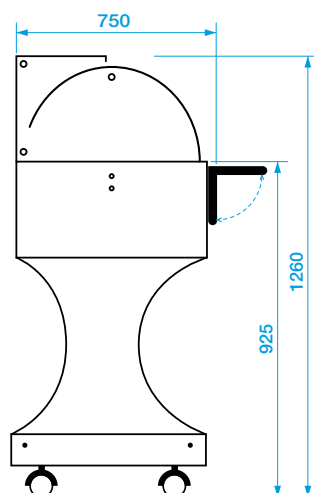

**Carrelli ed espositori refrigerati - Refrigerated trolleys and display cases**  
**Chariots et présentoirs réfrigérés - Wagen und gekühlter Ausstellungswagen**



**ELR 2827 (+2° +10°C)** € 2.790,00  
**ELR 2827 BT (-5° +5°C)** € 3.150,00  
**(Gastronorm 4x1/1 - h 150)**

**ELR 2827W (+2° +10°C)** € 2.790,00  
**ELR 2827 BTW (-5° +5°C)** € 3.150,00  
**(Gastronorm 4x1/1 - h 150)**

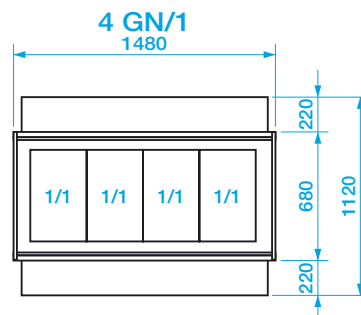
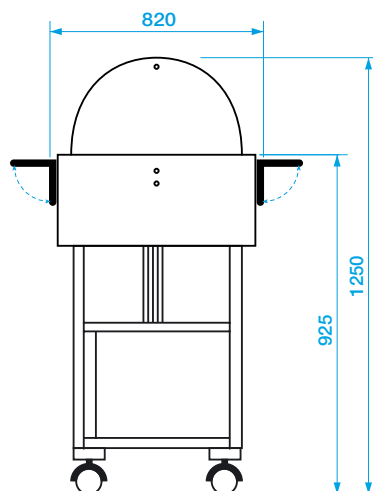



**Carrelli ed espositori refrigerati - Refrigerated trolleys and display cases**  
**Chariots et présentoirs réfrigérés - Wagen und gekühlter Ausstellungswagen**



**ELR 2826 (+2° +10°C) €2.790,00**

**ELR 2826 BT (-5° +5°C) €3.150,00**

**(Gastronorm 4x1/1 - h 150)**

**ELR 2826W (+2° +10°C) €2.790,00**

**ELR 2826 BTW (-5° +5°C) €3.150,00**

**(Gastronorm 4x1/1 - h 150)**

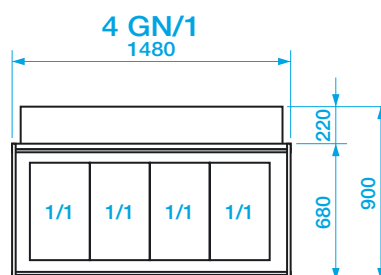
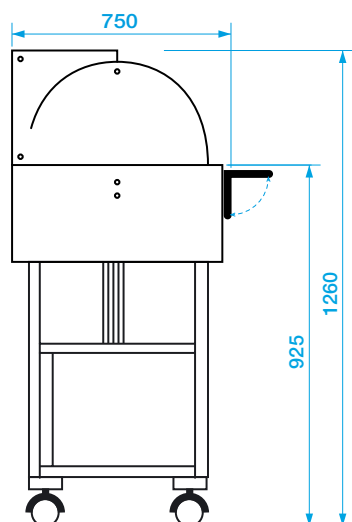



## Carrelli ed espositori refrigerati - Refrigerated trolleys and display cases

## Chariots et présentoirs réfrigérés - Wagen und gekühlter Ausstellungswagen

 **ESPOSITORE REFRIGERATO.** Struttura in legno massello. Cupola in plexiglass. Refrigerazione statica. Temperatura da +2° +10°C con coperchi posizionati. Voltaggio 230 V 50 Hz 250W. Gas refrigerante: R 134 A. Dotato di 2 mensole d'appoggio pieghevoli. Capacità n. 4 gastronorm 1/1 h 150 (bacinelle escluse).

 **REFRIGERATED DISPLAY CASE.** Solid wood frame. Plexiglass cover. Static refrigeration. Temperature between +2° +10°C when covers are positioned. 230 V 50 Hz 250W. Refrigerant: R134A. Equipped with 2 folding shelves. Capacity: 4 GN 1/1 H. 150 (containers not included).

 **PRESENTOIR RÉFRIGÉRÉ.** Structure en bois massif. Convercle en plexiglass. Réfrigération statique. Température de +2° +10°C avec les couvercles en position. Voltage 230V 50 Hz 250W. Gaz réfrigérant: R134 A. Equipé de 2 étagères pliables. Capacité 4 GN 1/1 h 150 (bacs exclus).

 **GEKÜHLTER AUSSTELLUNGSWAGEN.** Aufbau aus massivem Holz. Abdeckung aus Plexiglas. Statische Kühlung. Temperatur von 2°C bis 10°C (bei geschlossener Abdeckung). Versorgungsspannung 230 V, 50 Hz 250W. Kühlgas: R134A. Ausstattung mit 2 KlappbarerStützkonsolen klappbar. Kapazität 4 GN 1/1 h 150 (Schüsseln Ausgenommen).



**ELR 2825 (+2° +10°C) € 2.920,00**

**ELR 2825W (+2° +10°C) € 2.920,00**

**ELR 2825 BT (-5° +5°C) € 3.270,00**

**ELR 2825BTW (-5° +5°C) € 3.270,00**

**(Gastronorm 4x1/1 - h 150)**

**(Gastronorm 4x1/1 - h 150)**

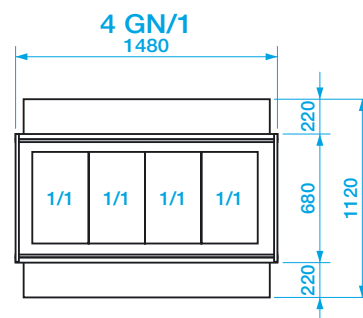
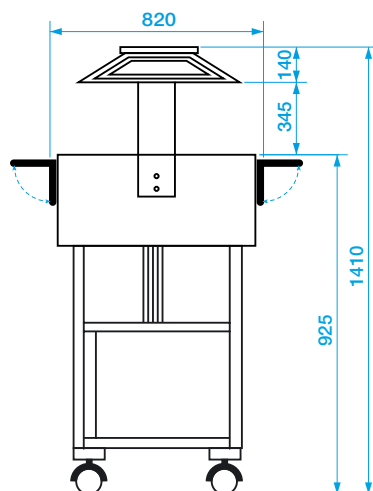



## Carrelli ed espositori refrigerati - Refrigerated trolleys and display cases Chariots et présentoirs réfrigérés - Wagen und gekühlter Ausstellungswagen

 **CARRELLO REFRIGERATO A PIASTRE EUTETTICHE.** Struttura portante in legno multistrato di betulla tinto noce con cupola in plx con vasca e griglia in acciaio inox. N° 8 piastre eutettiche. Adatto per dolci, formaggi, salumi e antipasti. Può contenere n° 5 bacinelle gastronom 1/4 65 h e n° 5 1/6 65 h. Portata complessiva kg 50.

 **EUTECTIC PLATE REFRIGERATED TROLLEY.** Multilayer birchwood walnut colour frame with plexiglass cover, stainless steel basin and grill, 8 eutectic plates. Suitable for desserts, cheese, sausages and hors d'oeuvres. It can hold 5 GN 1/4 H. 65 and n° 5 1/6 65 H. Total capacity 50 Kg.



 **CHARIOT RÉFRIGÉRÉ À PLAQUES EUTECTIQUES.** Structure porteuse en bois feuilleté de bouleau couleur noyer avec couvercle en plexiglass. Cuve et grille en acier inox. 8 plaques eutectiques. Indiqués pour la pâtisserie, les fromages, la charcuterie et les hors-d'oeuvres. Peut contenir 5 bacs gn 1/4 h 65 et n° 5 1/6 65 h. Portée totale 50 Kg.

 **KÜHLWAGEN MIT EUTEKTISCHEN PLATTEN.** Tragende Struktur aus vielschichtigem Birkenholz Nussbaum Farbe mit Abdeckkuppel aus Plexiglas. Wanne und Rost aus Inox-Stahl. 8 eutektische Platten, geeignet für Süßspeisen, Käse, Wurst und Vorspeisen. Kann 5 GN 1/4 h 65 und 5 1/6 65 h. Schüsseln aufnehmen. Tragfähigkeit 50 Kg.



**CL 2785**

**€ 1.390,00**

**CL 2785W**

**€ 1.390,00**

DIMENSIONI ESTERNE LxPxH cm  
EXTERNAL DIMENSIONS LxPxH cm  
DIMENSIONS EXTERIEURES LxPxH cm  
AUBENABMESSUNGEN LxPxH cm

**106x55x108 h**

 **CARRELLO REFRIGERATO IN LEGNO CON CUPOLA IN PLEXIGLASS.** Struttura in legno massello. Cupola in plexiglass. Refrigerazione statica. Temperatura da +2° +10°C (a cupola chiusa). Voltaggio 230 V 50 Hz 250W. Gas refrigerante: R 134 A. Capacità n. 3 gastronom 1/1 h 150. Dotato di 2 mensole d'appoggio pieghevoli (bacinelle escluse).

 **REFRIGERATED WOODEN TROLLEY WITH PLEXIGLASS.** Solid wood frame, Plexiglas cover. Static refrigeration. Temperature between +2° +10°C with dome closed. 230 V 50 Hz 250W. Refrigerant: R134A. Capacity: 3 GN 1/1 H. 150. Equipped with two folding shelves. Structure en bois massif, cloche en plexiglas (containers not included).



 **CHARIOT RÉFRIGÉRÉ EN BOIS AVEC CONVERCLE EN PLEXIGLASS.** Réfrigération statique. Température de +2° +10°C (cloche fermée). Voltage 230V 50 Hz 250W. Gaz réfrigérant: R134 A. Capacité 3 GN 1/1 h 150. Doté de 2 étagères pliable (bacs exclus).

 **KÜHLWAGEN AUS MASSIVEM HOLZ MIT PLEXIGLAS-ABDECKUNG.** Aufbau aus massivem Holz, Abdeckung aus Plexiglas. Statische Kühlung. Temperatur von 2 bis 10°C (bei geschlossener Abdeckung). Versorgungsspannung 230 V, 50 Hz 250W. Kühlgas: R134A. Kapazität 3 GN 1/1 h 150. Mit 2 Klappbar stützkonsole (Schüsseln Ausgenommen).

**CLR 2782 (+2° +10°C)**

**€ 2.900,00**

**CLR 2782W (+2° +10°C)**

**€ 2.900,00**

DIMENSIONI ESTERNE LxPxH cm  
EXTERNAL DIMENSIONS LxPxH cm  
DIMENSIONS EXTERIEURES LxPxH cm  
AUBENABMESSUNGEN LxPxH cm

**111x82x134 h**  
**GN 3x1/1 150 h**

### Optionals

**CLR311**

Vasca inox forata GN 3x1/1-H 100  
Stainless steel perforated container  
Bac inox perforée  
Behälter aus rostfreiem Stahl mit Löcher

**€ 130,00**

## Carrelli ed espositori refrigerati - Refrigerated trolleys and display cases

## Chariots et présentoirs réfrigérés - Wagen und gekühlter Ausstellungswagen

**🇮🇹 CARRELLO REFRIGERATO IN LEGNO CON CUPOLA IN PLEXIGLASS. CON LUCE AL NEON.** Struttura in legno massello. Cupola in plexiglass. Refrigerazione statica Temperatura da +2° +10°C con coperchi posizionati. Voltaggio 230 V 50 Hz. Gas refrigerante: R 134 A. Capacità n. 3 gastronorm 1/1 h 150. Dotato di 2 mensole d'appoggio pieghevoli (bacinelle escluse).

**🇬🇧 WOODEN REFRIGERATED CARTS WITH PLEXIGLAS DOMES AND NEON LIGHT.** Solid wood frame. Plexiglass cover. Static refrigeration. Temperature between +2° +10°C when covers are positioned. 230 V 50 Hz. Refrigerant: R134A. Capacity: 3 GN 1/1 H. 150. Equipped with two folding shelves (containers not included).



**🇫🇷 CHARIOT RÉFRIGÉRÉ EN BOIS AVEC CLOCHE EN PLEXIGLASS ET LAMPE NEON.** Structure en bois massif, couvercle en plexiglass. Réfrigération statique. Température de +2° +10°C avec les couvercles en position. Voltage 230V 50 Hz. Gaz réfrigérant: R134 A. Capacité 3 GN 1/1 h 150. Equipé de 2 étagères pliables (bacs exclus).

**🇩🇪 KÜHLWAGEN AUS MASSIVEM HOLZ MIT PLEXIGLAS-ABDECKUNG. MIT NEONLICHT.** Aufbau aus massivem Holz, Abdeckung aus Plexiglas. Statische Kühlung. Temperatur von 2°C bis 10°C (bei geschlossener Abdeckung). Versorgungsspannung 230 V, 50 Hz. Kühlgas: R134A. Kapazität 3 GN 1/1 h 150. Kapazität 3 GN 1/1 h 150. Mit 2 Klappbaren Stützkonsolen ausgestattet (Schüsseln Ausgenommen).

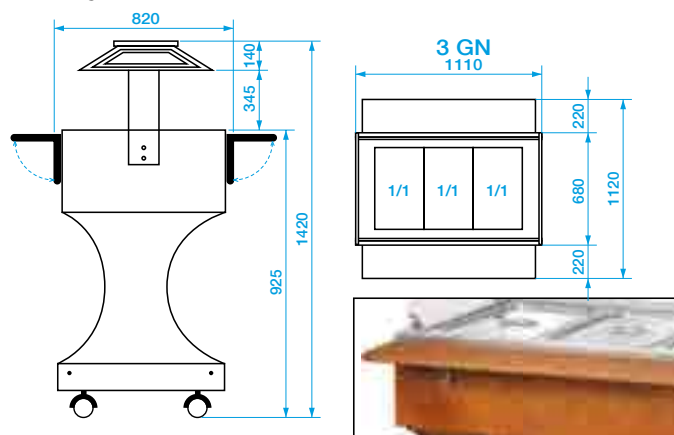

**CLR 2786 (+2° +10°C)**

**€ 2.800,00**

**CLR 2786W (+2° +10°C)**

**€ 2.800,00**

**Gastronorm 3x1/1 150 h**

**🇮🇹 CARRELLO REFRIGERATO IN LEGNO.** Struttura in legno massello. Refrigerazione statica. Temperatura da +2° +10°C con coperchi posizionati. Voltaggio 230 V 50 Hz. Gas refrigerante: R 134 A. Capacità n. 3 gastronorm 1/1 h 150. Dotato di 1 mensola d'appoggio pieghevole (bacinelle escluse).

**🇬🇧 WOODEN REFRIGERATED TROLLEY.** Solid wood frame. Static refrigeration. Temperature between +2° +10°C when covers are positioned. Refrigerant: R134A. Capacity: 3 GN 1/1 H. 150. Equipped with one folding shelf (containers not included).



**🇫🇷 CHARIOT RÉFRIGÉRÉ EN BOIS.** Structure en bois massif. Réfrigération statique. Température de +2° +10°C avec les couvercles en position. Voltage 230V 50 Hz. Gaz réfrigérant: R134 A. Capacité 3 GN 1/1 h 150. Equipé de 1 étagère pliable (bacs exclus).

**🇩🇪 KÜHLWAGEN AUS MASSIVEM HOLZ.** Aufbau aus massivem Holz. Statische Kühlung. Temperatur von 2°C bis 10°C (bei geschlossener Abdeckung). Versorgungsspannung 230 V, 50 Hz. Kühlgas: R134A. Kapazität 3 GN 1/1 h 150. Kapazität 3 GN 1/1 h 150. Mit 1 klappbarer Stützkonsole ausgestattet (Schüsseln Ausgenommen).

**CLR 2784 (+2° +10°C)**

**€ 2.700,00**

DIMENSIONI ESTERNE LxPxH cm  
EXTERNAL DIMENSIONS LxPxH cm  
DIMENSIONS EXTERIEURES LxPxH cm  
AUBENABMESSUNGEN LxPxH cm

**110x75x134 h**  
**Gastronorm 3x1/1 150 h**

### Optionals

**CLR311**

Vasca inox forata GN 3x1/1-H 100  
Stainless steel perforated container  
Bac inox perforée  
Behälter aus rostfreiem Stahl mit Löcher

**€ 130,00**

**Espositore caldo bagnomaria con cupola - Bain-marie warmed display case with dome**  
**Présentoir chauffé bain-marie avec cloche - Warme wasserbadausstellung mit kuppel**

 **ESPOSITORE CALDO BAGNOMARIA.** Struttura in legno massello. Cupola in plexiglass. Temperatura da +30° +90°C. Voltaggio 230 V 50 Hz. Riscaldato mediante resistenza elettrica W 2000. Dotato di 2 mensole d'appoggio pieghevoli. Capacità n. 3 gastronorm 1/1 h 150 (bacinelle escluse).

 **HOT DISPLAY CASE BAIN MARIE.** Solid wood frame. Plexiglass cover. Temperature between +30° +90°C. 230 V 50 Hz. Resistance heating W 2000. Equipped with 2 folding shelves. Capacity: 3 GN 1/1 H. 150 (containers not included).

 **PRESENTOIR CHAUD BAIN-MARIE.** Structure en bois massif. Convercle en plexiglass. Température de +30° +90°C. Voltage 230V 50 Hz. Chauffage à résistance électrique W 2000. Equipé de 2 étagères pliables. Capacité 3 GN 1/1 h 150 (bacs exclus).

 **WÄRME AUSTELLUNGWAGEN WASSERBÄDER.** Aufbau aus massivem Holz. Abdeckung aus Plexiglas. Temperatur von +30° bis +90°C. Versorgungsspannung 230 V, 50 Hz. Erwärmtn durch elektrischen Widerstand W 2000. Ausstattung mit 2 Klappbarer Stützkonsolen. Kapazität: 3 GN 1/1 h 150 (Schüsseln Ausgenommen).



**CL2777**

**€ 1.900,00**

**(Gastronorm 3x1/1 - h 150)**

**CL2777W**

**€ 1.900,00**

**(Gastronorm 3x1/1 - h 150)**

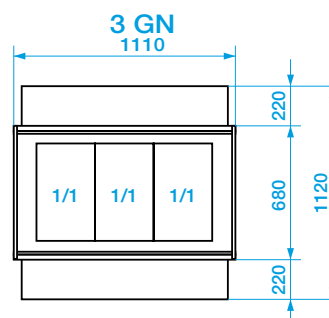
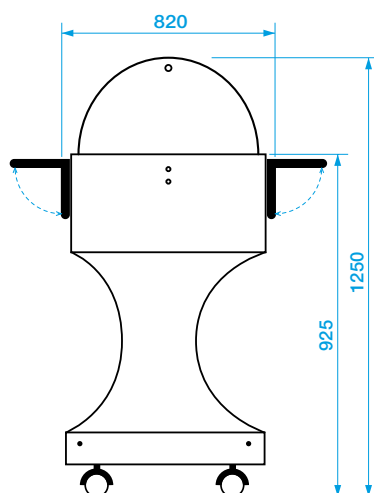

**Espositore caldo bagnomaria con cupola - Bain-marie warmed display case with dome**  
**Présentoir chauffé bain-marie avec cloche - Warme wasserbadausstellung mit kuppel**



**CL 2778**

**€ 1.900,00**

**(Gastronorm 3x1/1 - h 150)**

**CL 2778W**

**€ 1.900,00**

**(Gastronorm 3x1/1 - h 150)**

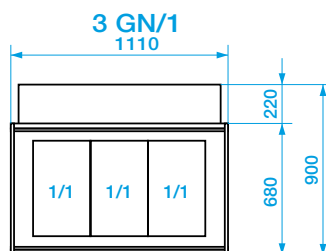
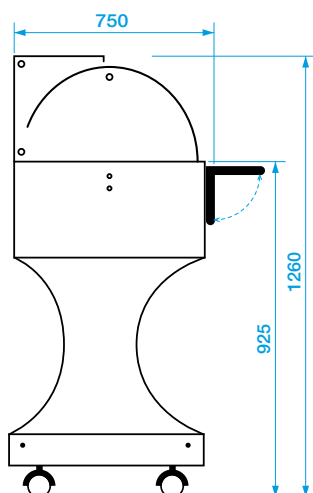

**Espositore caldo bagnomaria con cupola - Bain-marie warmed display case with dome**  
**Présentoir chauffé bain-marie avec cloche - Warme wasserbadausstellung mit kuppel**



**ELC 2832**

**€ 2.000,00**

**(Gastronorm 4x1/1 - h 150)**

**ELC 2832W**

**€ 2.000,00**

**(Gastronorm 4x1/1 - h 150)**

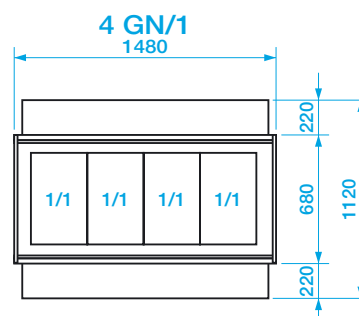
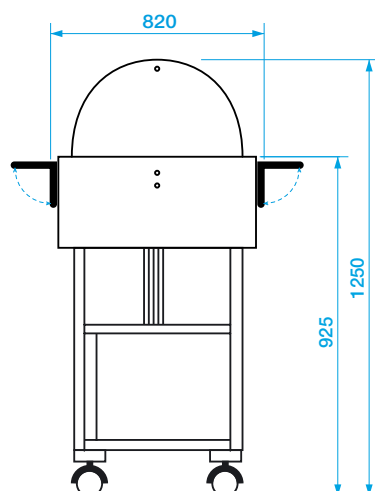

**Espositore caldo bagnomaria con cupola - Bain-marie warmed display case with dome**  
**Présentoir chauffé bain-marie avec cloche - Warme wasserbadausstellung mit kuppel**



**ELC 2834**

**€ 2.000,00**

**(Gastronorm 4x1/1 - h 150)**

**ELC 2834W**

**€ 2.000,00**

**(Gastronorm 4x1/1 - h 150)**

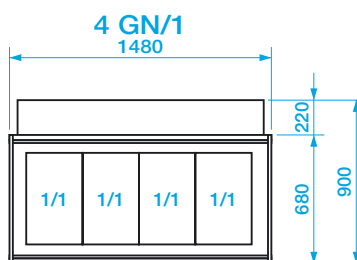
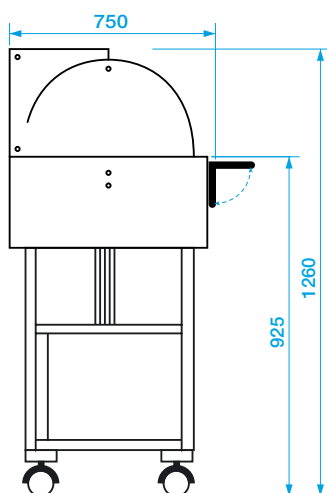





**Espositore caldo bagnomaria con cupola - Bain-marie warmed display case with dome**  
**Présentoir chauffé bain-marie avec cloche - Warme wasserbadausstellung mit kuppel**

 **ESPOSITORE CALDO BAGNOMARIA.** Struttura in legno massello. Cupola in plexiglass. Con luce al neon Temperatura da +30° +90°C. Voltaggio 230 V 50 Hz. Riscaldato mediante resistenza elettrica W 2000. Dotato di 2 mensole d'appoggio pieghevoli. Capacità n. 4 gastronorm 1/1 h 150 (bacinelle escluse).

 **HOT DISPLAY CASE BAIN MARIE.** Solid wood frame. Plexiglass cover. Neon light. Temperature between +30° +90°C. 230 V 50 Hz. Resistance heating W 2000. Equipped with 2 folding shelves. Capacity: 4 GN 1/1 H. 150 (containers not included).

 **PRESENTOIR CHAUD BAIN-MARIE.** Structure en bois massif. Couverture en plexiglass. Eclairage neon. Température de +30° +90°C. Voltage 230V 50 Hz. Chauffage à résistance électrique W 2000. Equipé de 2 étagères pliables. Capacité 4 GN 1/1 h 150 (bacs exclus).

 **WÄRME AUSTELLUNGSWAGEN WASSERBÄDER.** Aufbau aus massivem Holz. Abdeckung aus Plexiglas. Neonlicht. Temperatur von +30° bis +90°C. Versorgungsspannung 230 V, 50 Hz. Erwärmt durch elektrischen Widerstand W 2000. Ausstattung mit 2 Klappbarer Stützkonsolen. Kapazität: 4 GN 1/1 h 150 (Schüsseln Ausgenommen).



**ELC 2828**

**€ 2.140,00**

**Gastronorm 4x1/1 - h 150**



**ELC 2828W**

**€ 2.140,00**

**Gastronorm 4x1/1 - h 150**

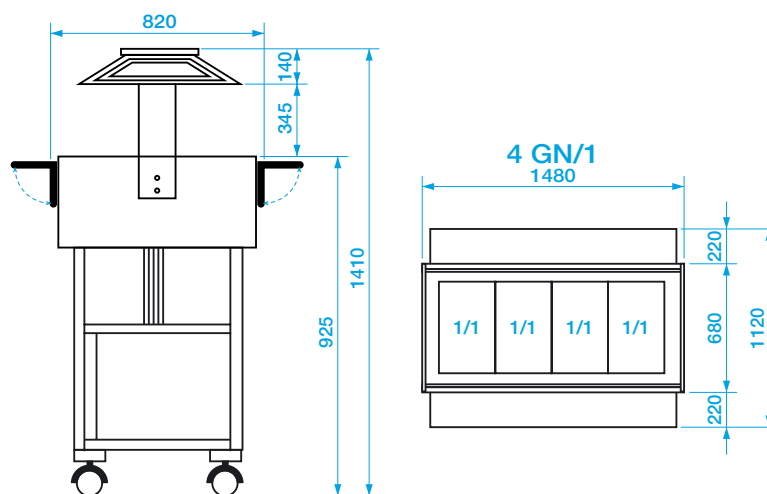

**Optionals**

**CF411**

Vasca inox forata 4X 1/1-H 100 - Stainless steel perforated container - Bac inox perforée - Behälter aus rostfreiem Stahl mit löcher

**€ 150,00**

## Bolliti e arrosti - Roast and boiled meat trolley

## Chariot pour bouillis et rotis - Wagen für Kochfleisch und Braten

 Struttura portante in legno multistrato di betulla tinto noce monocolpo. Vasca in acciaio inox per contenitori gastronorm munita di scarico. Riscaldamento mediante resistenza elettrica W 2000 230V 50/60 Hz (bacinelle escluse).

 Multilayer birchwood walnut colour monobloc frame. Stainless steel basin for gastronorm containers with drain pipe. Resistance heating W 2000 230V 50/60 Hz (containers not included).

 Chassis monobloc en bois feuilleté de bouleau couleur noyer. Bac en acier inoxydable pour cuvettes gastronorm, équipés d'égout. Chauffage à résistance électrique W 2000 230V 50/60 Hz (bacs exclus).



 Traggestell aus Vielschichtem Birkeholz Nussbaum Farbe von einem Block. Schal aus rostfreiem Stahl für Gastronorm. Behälter, mit Ablass. Erwärmt durch elektrischen Widerstand W 2000 230V 50/60 Hz (Schüsseln Ausgenommen).

**CL 2760** € 1.290,00

**CL 2760W** € 1.290,00

DIMENSIONI ESTERNE LxPxH cm  
EXTERNAL DIMENSIONS LxPxH cm  
DIMENSIONS EXTERIEURES LxPxH cm  
AUBENABMESSUNGEN LxPxH cm

**89x65x95 h**  
**GN 2x1/1 - h 150**

**CL 2770** € 1.480,00

**CL 2770W** € 1.480,00

DIMENSIONI ESTERNE LxPxH cm  
EXTERNAL DIMENSIONS LxPxH cm  
DIMENSIONS EXTERIEURES LxPxH cm  
AUBENABMESSUNGEN LxPxH cm

**123x65x95 h**  
**GN 3x1/1 - h 150**

### Optionals

**A 580** Portacoperchi inox  
Stainless steel lid-holder  
Porte-couvercles en acier inoxydable  
Deckelhalter aus Edelstahl € 95,00

**A 590** Portacoltelli - Knives-holder  
Porte-couteaux - Messerhalter € 55,00

**A 600** Scorrevole portapiatti con tagliere polietilene  
Sliding plate-holder with polyethylene chopping-board  
Porte-plat coulissant. Planche polyéthylène  
Tellerhalter mit Hackbrett aus Polyäthylen € 120,00

 Carrello termico bagnomaria in legno per buffet. Buffet caldo cap. 3x1/1 h. 150 GN (bacinelle escluse).

 Thermal bain-marie wooded trolley for barquets.

 Chariot thermique bain-marie en bois pour banquetts.

 Thermowagen Bain-Marie für Büffet.

**CL 2774** € 1.990,00

**CL 2774W** € 1.990,00

### Optionals

**C** N. 4 ruote con cuffia ottonata - 4 wheels with beassy covers € 130,00  
4 roues avec couverture cuivrée  
4 Räder mit Vermessinger Kappen

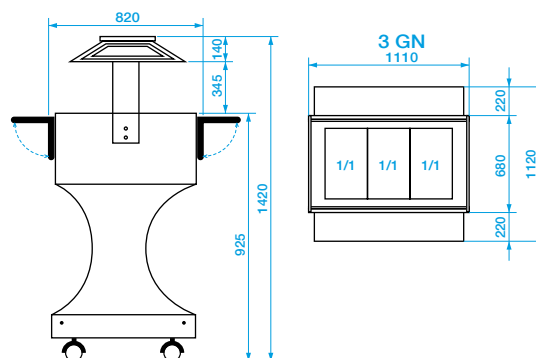

**Espositore caldo bagnomaria con cupola - Bain-marie warmed display case with dome**  
**Présentoir chauffé bain-marie avec cloche - Warme wasserbadausstellung mit kuppel**

- ESPOSITORE IN LEGNO NEUTRO. Struttura in legno massello. Cupola in plexiglas. Piano inox. Dotato di 2 mensola d'appoggio pieghevoli.
- Neutral wooden display case. Solid wood frame. Plexiglas cover. Stainless steel surface. Equipped with two folding shelves.



- Présentoir en bois neutre. Structure en bois massif. Couverture en Plexiglas. Dessus en acier inox. Equipé de deux étagères pliables.
- Neutraler Holzausstellungswagen. Aufbau aus massivem Holz. Abdeckung aus Plexiglas. Fläche aus rostfreier Stahl. Mit zwei klappbaren Stützkonsolen ausgerüstet.



**ELN 2835** € 1.640,00

**ELN 2835W** € 1.640,00

DIMENSIONI ESTERNE LxPxH cm  
 EXTERNAL DIMENSIONS LxPxH cm  
 DIMENSIONS EXTERIEURES LxPxH cm  
 AUBENABMESSUNGEN LxPxH cm

**147x82x141 h**



- CARRELLO TERMICO BAGNOMARIA IN LEGNO PER BUFFET. Buffet caldo cap. 3 x 1/1 h. 150 GN (bacinelle escluse).
- Thermal bain-marie wooden trolley for banquets.
- Chariot thermique bain-marie en bois pour banquets.
- Thermowagen Bain-Marie für Büffet.

**CL2772** € 1.800,00

DIMENSIONI ESTERNE LxPxH cm  
 EXTERNAL DIMENSIONS LxPxH cm  
 DIMENSIONS EXTERIEURES LxPxH cm  
 AUBENABMESSUNGEN LxPxH cm

**123x70x135 h**  
**GN 3x1/1 - h 150**

## Mensole legno per unione - Connection wooden shelves Etagères en bois pour connexion - Holzregale für Verbindung

 Mensole legno per unione - Angolo legno per unione espositori.

 Connection wooden shelves - Wooden angle bracket to connect the displays.

 Etagères en bois pour connexion - Angle en bois pour union présentoirs.

 Holzregale für Verbindung - Holzkante für Ausstellerverbindung.

### PER MODELLI / FOR MODEL

|         |         |         |         |         |
|---------|---------|---------|---------|---------|
| CLR2782 | CLR2784 | CLR2786 | CLR2787 | CLR2788 |
| ELR2825 | ELR2826 | ELR2827 |         |         |
| ELC2828 | ELC2832 | ELC284  |         |         |
| CL2770  | CL2772  | CL2774  | CL2777  | CL2778  |

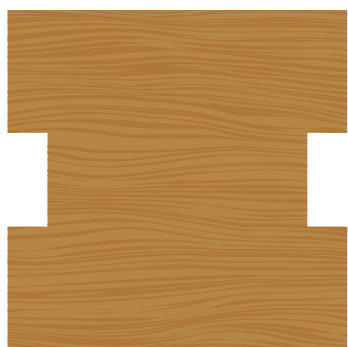

#### **MLUN**

**€ 130,00**

DIMENSIONI ESTERNE LxPxH cm  
EXTERNAL DIMENSIONS LxPxH cm  
DIMENSIONS EXTERIEURES LxPxH cm  
AUBENABMESSUNGEN LxPxH cm

**68x70**

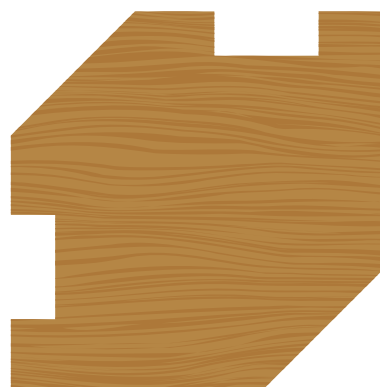

#### **ANUN**

**€ 160,00**

DIMENSIONI ESTERNE LxPxH cm  
EXTERNAL DIMENSIONS LxPxH cm  
DIMENSIONS EXTERIEURES LxPxH cm  
AUBENABMESSUNGEN LxPxH cm

**88x88**

#### **MLUNW (WENGÈ)**

**€ 130,00**



#### **ANUN W(WENGÈ)**

**€ 160,00**





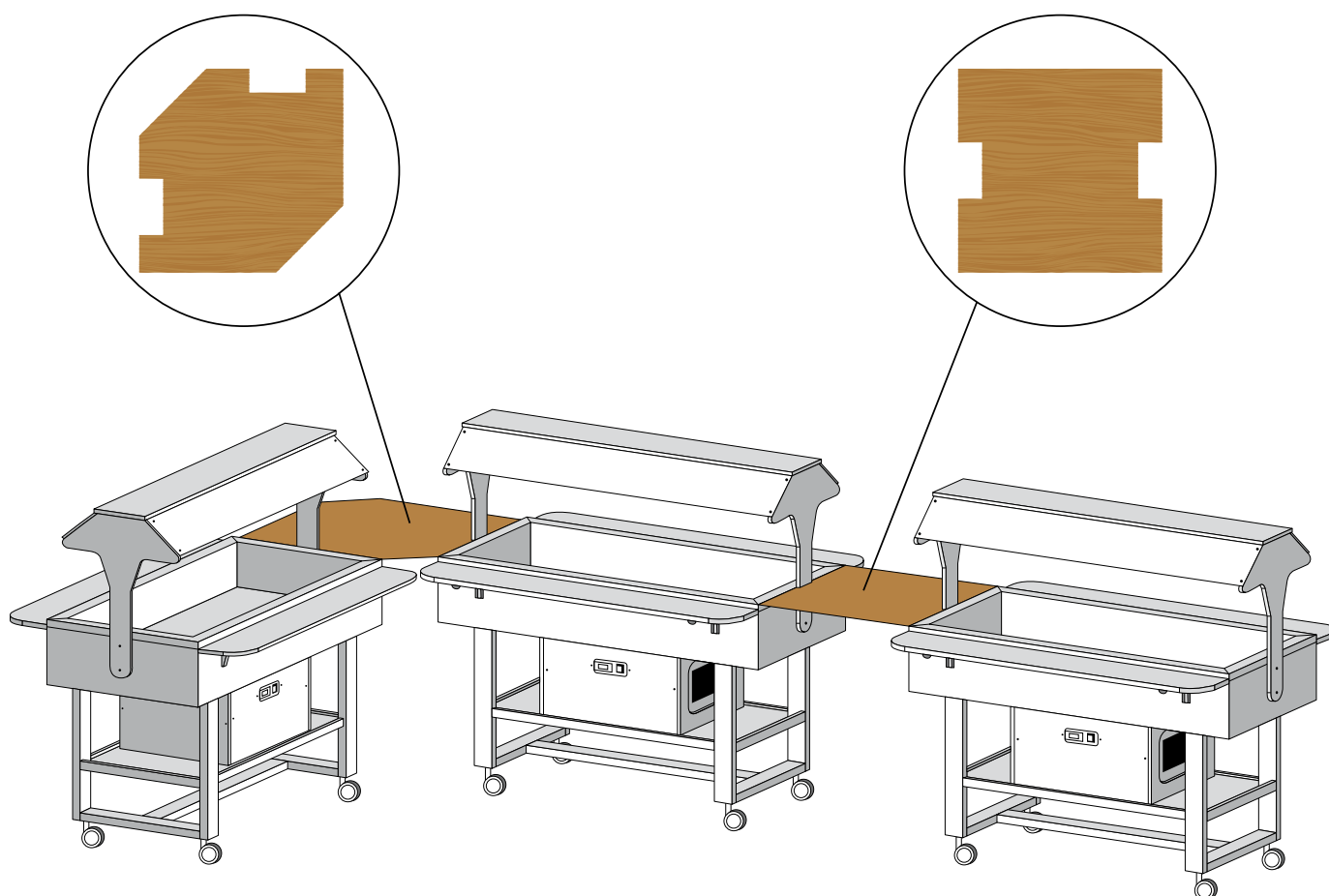
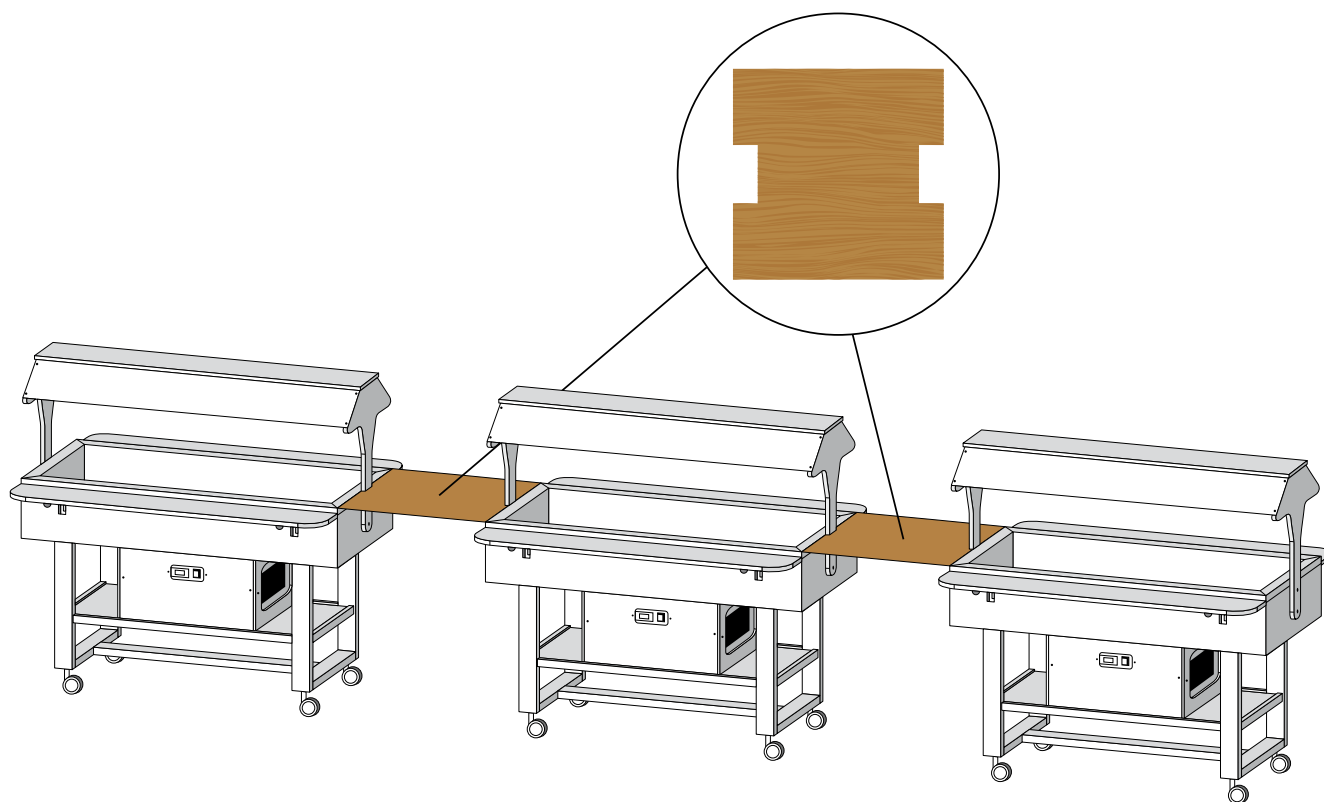

**Mensole legno per unione - Connection wooden shelves**  
**Etagères en bois pour connexion - Holzregale für Verbindung**



## **Bolliti e arrosti - Roast and boiled meat trolley**

### **Chariot pour bouillis et rotis - Wagen für Kochfleisch und Braten**

-  **BOLLITI E ARROSTI.** Carrello per bolliti struttura portante in legno massello colore mogano cupola ovale inox lucido roll top vasca inox bagnomaria riscaldata con bruciatori ad alcool con portacoltelli e portapiatti.
-  **ROAST AND BOILED MEAT TROLLEY.** Trolley for boiled meat. Solid wood frame mahogany coloured. Oval polished s/steel roll top cover. S/steel bain-marie container heated by alcohol burners. Knife and plate-holder.
-  **CHARIOT POUR BOUILLIS ET ROTIS.** Chariot pour bouillis structure en bois massif. Couleur acajou. Couvercle oval en acier inoxydable brillant roll top. Bac en acier inoxydable bain-marie chauffée par brûleurs à alcool avec porte-couteaux et porte-plats.
-  **WAGEN FÜR KOCHFLEISCH UND BRATEN.** Wagen für Kochfleisch mit Struktur aus massiven Holz, Farbe mahagonibaumholz Ovaler Deckel aus polierten rostfreiem Stahl Roll Top, Wanne Bain-Marie aus rostfreiem Stahl mit Alkoholbrenner Geheizt. Messer- und Tellerhalter.

-  **ROAST BEEF.** Struttura portante in legno massello colore mogano. Cupola inox lucido roll top. Vasca inox bagnomaria riscaldata con piastra elettrica W 360 230V 50/60 Hz e con bruciatori ad alcool. Tagliere in polietilene. Due contenitori. Portacoltelli e portapiatti.
-  **ROAST BEEF.** Solid wood frame mahogany coloured. Polished s/steel roll top cover stainless. Steel bain-marie container with electric plate heating unit W 360 230V 50/60 Hz and with alcohol burners. Polyethylene chopping board. Two containers. Knife and plate-holder.
-  **ROAST BEEF.** Structure en bois massif, couleur acajou. Couvercle en acier inoxydable brillant roll top. Bac en acier inoxydable bain-marie chauffée par une plaque électrique W 360 230V 50/60 Hz et brûleurs à alcool. Planche à hacher en polyéthylène. Deux récipients Porte-couteaux et porte-plats.
-  **ROAST BEEF.** Struktur aus massiven Holz, Mahagoni farbe. Deckel aus polierten rostfreiem Stahl Roll top. Wanne Bain-Marie aus rostfreiem Stahl mit elektrischer Platte geheizt W 360 230V 50/60 Hz und mit Alkoholbrenner. Hackbrett aus Polyethylen. Zwei. Behälter. Messer- und Tellerhalter.



**CB 8802**

**€ 1.250,00**

DIMENSIONI ESTERNE LxPxH cm  
EXTERNAL DIMENSIONS LxPxH cm  
DIMENSIONS EXTERIEURES LxPxH cm  
AUBENABMESSUNGEN LxPxH cm

**78x63x105 h**



**CR 0103**

**€ 5.200,00**

DIMENSIONI ESTERNE LxPxH cm  
EXTERNAL DIMENSIONS LxPxH cm  
DIMENSIONS EXTERIEURES LxPxH cm  
AUBENABMESSUNGEN LxPxH cm

**85x55x112 h**

## ***Tavole calde da banco***



***Tavole calde da banco - bagnomaria / Tavole calde da banco con resistenza a secco  
Tavola calda con pentola / Mobiletti scaldapiatti / Piani caldi inox  
Piani caldi inox con piano in vetro temperato / Piani caldi con cupola in plexiglass  
Con lampade a raggi infrarossi / Telaio con lampade infrarossi  
Contenitore gn per condimento e mantenimento fritti***

## ***Vetrine bar***

## ***Lunch counters***



***Lunch counters - double boiler / Lunch counters with dry heating element  
Lunch table double boiler with pot / Plate warming cabinets / Stainless steel warming surfaces  
Stainless steel warming surfaces with surface in tempered glass  
Warming surfaces with plexiglass cover / With infrared lamps / Frame with infrared lamps  
Gn container for sauces and fried keeping***

## ***Showcases for bar***

## ***Tables chauffées pour comptoir***



***Tables chauffées pour comptoir - bain-marie / Tables chauffées pour comptoir avec résistance à sec  
Table chauffée bain-marie avec marmite / Meubles chauffe-plats / Plateaux chauffés en inox  
Plateaux chauffés en inox avec plateaux en verre tempéré  
Plateaux chauffés avec couvercle en plexiglass / Avec lampes à infrarouges  
Chassis avec lampes infrarouges / Cuve gn pour assaisonnement et maintien des fritures***

## ***Vitrines pour bar***

## ***Heiztische***



***Heiztische - wasserbäder / Heiztische mit trockenem thermoelement  
Heiztische wasserbäder mit kochtopf / Tellerwärmemöbel / Heizplatten aus rostfreiem stahl  
Heizplatten aus rostfreiem stahl mit fläche aus gehärtetem glas  
Heizplatten mit deckel aus plexiglass / Mit infrarotlampen / Gestell mit infrarotlampen  
Gn behälter für würzen und erhaltung des ausgebackenes***

## ***Bar-warmvitrinen***

## Tavole calde da banco - Lunch counters Tables chauffées pour comptoir - Heiztische

- 🇮🇹 TAVOLE CALDE DA BANCO - BAGNOMARIA. Struttura in acciaio inox (bacinelle escluse). Termostato regolabile 30°-90°C, V230 50/60 Hz + termostato limite salvaresistenza. Con rubinetto di scarico.
- 🇬🇧 LUNCH COUNTERS - DOUBLE BOILER. Stainless steel frame (containers not included). Adjustable thermostat 30°-90°C, V230 50/60 Hz + thermostat resistance protector. With drain tap.

- 🇫🇷 TABLES CHAUFFÉES POUR COMPTOIR - BAIN-MARIE. Structure en acier inox (cuvettes exclues). Thermostat réglable 30°-90°C, V230 50/60 Hz + thermostat limite protégé-résistance. Avec robinet d'évacuation.
- 🇩🇪 HEIZTISCHE - WASSERBÄDER. Gestell aus rostfreiem Stahl (Behälter nicht inbegriffen). Regulierbares Thermostat: 30°-90°C, V230 50/60 Hz + Schutzthermostat. Mit Auslasshahn.



### **BM 1780 (1x1/1 GN)** € 550,00

|  |                       |
|--|-----------------------|
| DIMENSIONI ESTERNE - EXTERNAL DIMENSIONS LxPxH cm  | <b>49x60x32 h</b>     |
| DIMENSIONS EXTERIEURES - AUßENABMESSUNGEN LxPxH cm | <b>1x1/1 GN 200 h</b> |
|  | <b>2000 W</b>         |

### **BM 1784 (3x1/1 GN)** € 700,00

|  |                       |
|--|-----------------------|
| DIMENSIONI ESTERNE - EXTERNAL DIMENSIONS LxPxH cm  | <b>110x60x32 h</b>    |
| DIMENSIONS EXTERIEURES - AUßENABMESSUNGEN LxPxH cm | <b>3x1/1 GN 200 h</b> |
|  | <b>2000 W</b>         |

### **BM 1782 (2x1/1 GN)** € 620,00

|  |                       |
|--|-----------------------|
| DIMENSIONI ESTERNE - EXTERNAL DIMENSIONS LxPxH cm  | <b>78x60x32 h</b>     |
| DIMENSIONS EXTERIEURES - AUßENABMESSUNGEN LxPxH cm | <b>2x1/1 GN 200 h</b> |
|  | <b>2000 W</b>         |

### **BM 1786 (4x1/1 GN)** € 800,00

|  |                       |
|--|-----------------------|
| DIMENSIONI ESTERNE - EXTERNAL DIMENSIONS LxPxH cm  | <b>144x60x32 h</b>    |
| DIMENSIONS EXTERIEURES - AUßENABMESSUNGEN LxPxH cm | <b>4x1/1 GN 200 h</b> |
|  | <b>2000 W</b>         |

- 🇮🇹 TAVOLE CALDE DA BANCO CON RESISTENZA A SECCO (senza acqua). Termostato regolabile 30°-90°C, V230 50/60 Hz.
- 🇬🇧 LUNCH COUNTERS WITH DRY HEATING ELEMENT (without water). Adjustable thermostat 30°-90°C, V230 50/60 Hz.

- 🇫🇷 TABLES CHAUFFÉES POUR COMPTOIR AVEC RÉSIDENCE À SEC (sans eau). Thermostat réglable 30°-90°C, V230 50/60 Hz.
- 🇩🇪 HEIZTISCHE MIT TROCKEM THERMOELEMENT (ohne Wasser). Regulierbares Thermostat: 30°-90°C, V230 50/60 Hz.



### **BMS 1781 (1x1/1 GN)** € 520,00

|  |                       |
|--|-----------------------|
| DIMENSIONI ESTERNE - EXTERNAL DIMENSIONS LxPxH cm  | <b>49x60x32 h</b>     |
| DIMENSIONS EXTERIEURES - AUßENABMESSUNGEN LxPxH cm | <b>1x1/1 GN 200 h</b> |
|  | <b>1000 W</b>         |

### **BMS 1783 (2x1/1 GN)** € 600,00

|  |                       |
|--|-----------------------|
| DIMENSIONI ESTERNE - EXTERNAL DIMENSIONS LxPxH cm  | <b>78x60x32 h</b>     |
| DIMENSIONS EXTERIEURES - AUßENABMESSUNGEN LxPxH cm | <b>2x1/1 GN 200 h</b> |
|  | <b>1000 W</b>         |

### **BMS 1785 (3x1/1 GN)** € 700,00

|  |                       |
|--|-----------------------|
| DIMENSIONI ESTERNE - EXTERNAL DIMENSIONS LxPxH cm  | <b>110x60x32 h</b>    |
| DIMENSIONS EXTERIEURES - AUßENABMESSUNGEN LxPxH cm | <b>3x1/1 GN 200 h</b> |
|  | <b>2000 W</b>         |



## Tavole calde da banco - Lunch counters Tables chauffées pour comptoir - Heiztische

- 🇮🇹 Struttura in acciaio inox (bacinelle escluse). Termostato regolabile 30°-90°C, V230 50/60 Hz.
- 🇬🇧 Stainless steel frame (containers not included). Adjustable thermostat 30°-90°C, V230 50/60 Hz.

- 🇫🇷 Structure in acier inox (cuvettes exclues). Thermostat réglable 30°-90°C, V230 50/60 Hz.
- 🇩🇪 Gestell aus rostfreiem Stahl (Behälter nicht inbegriffen). Regulierbares Thermostat: 30°-90°C, V230 50/60 Hz.



### **BM 11 (1x1/1 GN)**

**€ 270,00**

DIMENSIONI ESTERNE - EXTERNAL DIMENSIONS LxPxH cm  
DIMENSIONS EXTERIEURES - AUßENABMESSUNGEN LxPxH cm

**54x33x22 h**  
**1x1/1 GN 150 h**

**1200 W**

### **BM 21 (2x1/1 GN)**

**€ 420,00**

DIMENSIONI ESTERNE - EXTERNAL DIMENSIONS LxPxH cm  
DIMENSIONS EXTERIEURES - AUßENABMESSUNGEN LxPxH cm

**66x54x22 h**  
**2x1/1 GN 150 h**

**1200 W + 1200 W**

### **BM 31 (3x1/1 GN)**

**€ 550,00**

DIMENSIONI ESTERNE - EXTERNAL DIMENSIONS LxPxH cm  
DIMENSIONS EXTERIEURES - AUßENABMESSUNGEN LxPxH cm

**99x54x22 h**  
**3x1/1 GN 150 h**

**1000 W + 1000 W + 1000 W**



TEMPERATURE DIFFERENZIATE - CON RUBINETTO DI SCARICO  
DIFFERENT TEMPERATURES - WITH DRAIN TAP  
TEMPERATURES DIFFÉRENTES - AVEC ROBINET D'ÉVACUATION  
VERSCHIEDENE TEMPERATUREN - MIT AUSLASSHAHN

### **BMV 11 (1x1/1 GN)**

**€ 310,00**

DIMENSIONI ESTERNE - EXTERNAL DIMENSIONS LxPxH cm  
DIMENSIONS EXTERIEURES - AUßENABMESSUNGEN LxPxH cm

**54x33x22 h**  
**1x1/1 GN 150 h**

**1200 W**

### **BMV 21 (2x1/1 GN)**

**€ 480,00**

DIMENSIONI ESTERNE - EXTERNAL DIMENSIONS LxPxH cm  
DIMENSIONS EXTERIEURES - AUßENABMESSUNGEN LxPxH cm

**66x54x22 h**  
**2x1/1 GN 150 h**

**1200 W + 1200 W**

### **BMV 31 (3x1/1 GN)**



**€ 650,00**



DIMENSIONI ESTERNE - EXTERNAL DIMENSIONS LxPxH cm  
DIMENSIONS EXTERIEURES - AUßENABMESSUNGEN LxPxH cm

**99x54x22 h**  
**3x1/1 GN 150 h**

**1000 W + 1000 W + 1000 W**

## Tavole calde da banco - Lunch counters Tables chauffées pour comptoir - Heiztische

-  TAVOLA CALDA. Tavola calda bagnomaria acciaio inox Cap. 1/1 H 150 GN W 1200 230 V 50/60 Hz (bacinelle escluse).
-  LUNCH TABLE DOUBLE BOILER. Lunch table double boiler stainless steel. Capacity 1/1 h 150 GN W 1200 230 V 50/60 Hz (containers not included).

-  TABLE CHAUFFÉE BAINMARIE. Table chauffée bain-marie acier inoxydable. Capacité 1/1 h 150 GN W 1200 230 V 50/60 Hz (bacs exclus).
-  HEIZTISCHE WASSERBÄDER. Heitzisch Wasserbäder aus rostfreiem Stahl. Kapazität 1/1 h 150 GN W 1200 230 V 50/60 Hz (Schüsseln Ausgenommen).







**BM 7700**

**€ 165,00**

DIMENSIONI ESTERNE LxPxH cm  
EXTERNAL DIMENSIONS LxPxH cm  
DIMENSIONS EXTERIEURES LxPxH cm  
AUßENABMESSUNGEN LxPxH cm

**57x37x22 h**

-  TAVOLA CALDA CON PENTOLA. Tavola calda bagnomaria acciaio inox. Cap. 1/1 con 2 pentole Lt. 8, W 1200 230 V 50/60 Hz.
-  LUNCH TABLE DOUBLE BOILER WITH POT. Lunch table double boiler stainless steel. Capacity 1/1 with 2 pots Lt. 8, W 1200 230 V 50/60 Hz.

-  TABLE CHAUFFÉE BAIN-MARIE AVEC MARMITE. Table chauffée bain-marie acier inoxydable. Capacité 1/1 avec 2 marmites Lt. 8, W 1200 230 V 50/60 Hz.
-  HEIZTISCHE WASSREBÄDER MIT KOCHTOPF. Heitzisch Wasserbäder aus rostfreiem Stahl. Kapazität 1/1 mit 2 kochtöpfe Lt. 8, W 1200 230 V 50/60 Hz.







**BMP 7720**

**€ 240,00**

DIMENSIONI ESTERNE LxPxH cm  
EXTERNAL DIMENSIONS LxPxH cm  
DIMENSIONS EXTERIEURES LxPxH cm  
AUßENABMESSUNGEN LxPxH cm





**57x37x28 h**

## Piani caldi inox - Stainless steel warming surfaces Plateaux chauffés en inox - Heizplatten aus rostfreiem stahl

-  **PIANI CALDI INOX.** Struttura in acciaio inox. Termostato regolabile 30°-90°C, V 230 50/60 Hz.
  **PLATEAUX CHAUFFÉS EN INOX.** Structure in acier inox. Thermostat réglable 30°-90°C, V 230 50/60 Hz.
-  **STAINLESS STEEL WARMING SURFACES.** Stainless steel frame. Adjustable thermostat 30°-90°C, V 230 50/60 Hz.
  **HEIZPLATTEN AUS ROSTFREIEM STAHL.** Gestell aus rostfreiem Stahl. Regulierbares Thermostat: 30°-90°C, V 230 50/60 Hz.



|   |                  |   |                  |   |                   |
|---|------------------|---|------------------|---|-------------------|
| <b>PC 4750</b>  | <b>€ 165,00</b>  | <b>PC 4752</b>  | <b>€ 205,00</b>  | <b>PC 4754</b>  | <b>€ 250,00</b>   |
| DIMENSIONI ESTERNE LxPxH cm<br>EXTERNAL DIMENSIONS LxPxH cm<br>DIMENSIONS EXTERIEURES LxPxH cm<br>AUBENABMESSUNGEN LxPxH cm | <b>50x35x6 h</b> | DIMENSIONI ESTERNE LxPxH cm<br>EXTERNAL DIMENSIONS LxPxH cm<br>DIMENSIONS EXTERIEURES LxPxH cm<br>AUBENABMESSUNGEN LxPxH cm | <b>90x45x6 h</b> | DIMENSIONI ESTERNE LxPxH cm<br>EXTERNAL DIMENSIONS LxPxH cm<br>DIMENSIONS EXTERIEURES LxPxH cm<br>AUBENABMESSUNGEN LxPxH cm | <b>100x50x6 h</b> |
|   | <b>250 W</b>     |   | <b>450 W</b>     |   | <b>600 W</b>      |
| <b>PC 5050</b>  | <b>€ 205,00</b>  | <b>PC 6040</b>  | <b>€ 205,00</b>  | <b>PC 8060</b>  | <b>€ 260,00</b>   |
| DIMENSIONI ESTERNE LxPxH cm<br>EXTERNAL DIMENSIONS LxPxH cm<br>DIMENSIONS EXTERIEURES LxPxH cm<br>AUBENABMESSUNGEN LxPxH cm | <b>50x50x6 h</b> | DIMENSIONI ESTERNE LxPxH cm<br>EXTERNAL DIMENSIONS LxPxH cm<br>DIMENSIONS EXTERIEURES LxPxH cm<br>AUBENABMESSUNGEN LxPxH cm | <b>60x40x6 h</b> | DIMENSIONI ESTERNE LxPxH cm<br>EXTERNAL DIMENSIONS LxPxH cm<br>DIMENSIONS EXTERIEURES LxPxH cm<br>AUBENABMESSUNGEN LxPxH cm | <b>80x60x6 h</b>  |
|   | <b>600 W</b>     |   | <b>600 W</b>     |   | <b>1000 W</b>     |

-  **PIANI CALDI INOX CON PIANO IN VETRO TEMPERATO.** Struttura in acciaio inox. Termostato regolabile 30°-90°C, V 230 50/60 Hz.
  **PLATEAUX CHAUFFÉS EN INOX AVEC PLATEAUX EN VERRE TEMPÉRÉ.** Structure in acier inox. Thermostat réglable 30°-90°C, V 230 50/60 Hz.
-  **STAINLESS STEEL WARMING SURFACES WITH SURFACE IN TEMPERATED GLASS.** Stainless steel frame. Adjustable thermostat 30°-90°C, V 230 50/60 Hz.
  **HEIZPLATTEN AUS ROSTFREIEM STAHL MIT FLÄCHE AUS GEHÄRTETEM GLAS.** Gestell aus rostfreiem Stahl. Regulierbares Thermostat: 30°-90°C, V 230 50/60 Hz.



|   |                  |   |                  |   |                  |
|---|------------------|---|------------------|---|------------------|
| <b>PVC 4760</b>   | <b>€ 215,00</b>  | <b>PVC 4763</b>   | <b>€ 210,00</b>  | <b>PVC 4765</b>   | <b>€ 290,00</b>  |
| DIMENSIONI ESTERNE LxPxH cm<br>EXTERNAL DIMENSIONS LxPxH cm<br>DIMENSIONS EXTERIEURES LxPxH cm<br>AUBENABMESSUNGEN LxPxH cm | <b>50x50x7 h</b> | DIMENSIONI ESTERNE LxPxH cm<br>EXTERNAL DIMENSIONS LxPxH cm<br>DIMENSIONS EXTERIEURES LxPxH cm<br>AUBENABMESSUNGEN LxPxH cm | <b>60x40x7 h</b> | DIMENSIONI ESTERNE LxPxH cm<br>EXTERNAL DIMENSIONS LxPxH cm<br>DIMENSIONS EXTERIEURES LxPxH cm<br>AUBENABMESSUNGEN LxPxH cm | <b>81x61x7 h</b> |
|   | <b>600 W</b>     |   | <b>600 W</b>     |   | <b>1000 W</b>    |

**Piani caldi con cupola in plexiglass - Warming surfaces with plexiglass cover**  
**Plateaux chauffés avec couvercle en plexiglass - Heizplatten mit deckel aus plexiglass**

 **PIANI CALDI CON CUPOLA IN PLEXIGLASS.** Struttura in acciaio inox. Termostato regolabile 30°-90°C, V 220, W 450.

 **WARMING SURFACES WITH PLEXIGLASS COVER.** Stainless steel frame. Adjustable thermostat 30°-90°C, V 220, W 450.

 **PLATEAUX CHEUFFÉS AVEC COUVERCLE EN PLEXIGLASS.** Structure in acier inox. Thermostat réglable 30°-90°C, V 220, W 450.

 **HEIZPLATTEN MIT DECKEL AUS PLEXIGLASS.** Gestell aus rostfreiem Stahl. Regulierbares Thermostat: 30°-90°C, V 220, W 450.



**PCC 4710**

**€ 425,00**

DIMENSIONI ESTERNE LxPxH cm  
 EXTERNAL DIMENSIONS LxPxH cm  
 DIMENSIONS EXTERIEURES LxPxH cm  
 AUBENABMESSUNGEN LxPxH cm

**90x45x20 h**

**450 W**

 **PIANI CALDI CON CUPOLA IN PLEXIGLASS.** Cupola in plexiglass semicilindrica a due aperture.

 **WARMING SURFACES WITH PLEXIGLASS COVER.** Semicircular plexiglass cover with two openings.

 **PLATEAUX CHEUFFÉS AVEC COUVERCLE EN PLEXIGLASS.** Couvercle en plexiglass semi-cylindrique à deux ouvertures.

 **HEIZPLATTEN MIT DECKEL AUS PLEXIGLASS.** Halbzyllindrischer Deckel aus Plexiglas mit zwei Öffnungen.



**PCC 4730**

**€ 435,00**

DIMENSIONI ESTERNE LxPxH cm  
 EXTERNAL DIMENSIONS LxPxH cm  
 DIMENSIONS EXTERIEURES LxPxH cm  
 AUBENABMESSUNGEN LxPxH cm

**100x50x30 h**

**600 W**

**Piani caldi inox con lampade a raggi infrarossi - Stainless steel warming surfaces with infrared lamps**  
**Plateaux chauffés en inox avec lampes à infrarouges - Heizplatten aus rostfreiem stahl mit infrarotlampen**

CON LAMPADE A RAGGI INFRAROSSI. Struttura in acciaio inox. Termostato regolabile 30°-90°C, V 230 50/60 Hz. Copertura in polycarbonato fumé.

WITH INFRARED LAMPS. Stainless steel frame. Adjustable thermostat 30°-90°C, V 230 50/60 Hz. Polycarbonate cover grey colour.

AVEC LAMPES À INFRAROUGES. Structure in acier inox. Thermostat réglable 30°-90°C, V 230 50/60 Hz. Couverture en polycarbonate gris.



MIT INFRAROTLAMPEN. Gestell aus rostfreiem Stahl. Regulierbares Thermostat: 30°-90°C, V 230 50/60 Hz. Bedeckung aus Polycarbonat Farbe grau.

**PCI 4711 € 390,00**

DIMENSIONI ESTERNE - EXTERNAL DIMENSIONS LxPxH cm **45x64x80 h**  
 DIMENSIONS EXTERIEURES - AUBENABMESSUNGEN LxPxH cm

**1 lampada - lamp - lampe - Lampe: 250 W + 250 W**

**PCI 4712 € 490,00**

DIMENSIONI ESTERNE - EXTERNAL DIMENSIONS LxPxH cm **85x64x80 h**  
 DIMENSIONS EXTERIEURES - AUBENABMESSUNGEN LxPxH cm

**2 lampade - lamps - lampes - Lampen: 450 W + 500 W**

**PCI 4713 € 610,00**

DIMENSIONI ESTERNE - EXTERNAL DIMENSIONS LxPxH cm **127x68x80 h**  
 DIMENSIONS EXTERIEURES - AUBENABMESSUNGEN LxPxH cm

**3 lampade - lamps - lampes - Lampen: 600 W + 750 W**

TELAIO CON LAMPADE INFRAROSSI.

FRAME WITH INFRARED LAMPS.

CHASSIS AVEC LAMPES INFRAROUGES.

GESTELL MIT INFRAROTLAMPEN.



**PI 4714 € 250,00**

DIMENSIONI ESTERNE - EXTERNAL DIMENSIONS LxPxH cm **45x55x70 h**  
 DIMENSIONS EXTERIEURES - AUBENABMESSUNGEN LxPxH cm

**1 lampada - lamp - lampe - Lampe: Hz 250 W**

**PI 4715 € 330,00**

DIMENSIONI ESTERNE - EXTERNAL DIMENSIONS LxPxH cm **85x55x70 h**  
 DIMENSIONS EXTERIEURES - AUBENABMESSUNGEN LxPxH cm

**2 lampade - lamps - lampes - Lampen: 500 W**

**PI 4716 € 410,00**

DIMENSIONI ESTERNE - EXTERNAL DIMENSIONS LxPxH cm **127x55x70 h**  
 DIMENSIONS EXTERIEURES - AUBENABMESSUNGEN LxPxH cm

**3 lampade - lamps - lampes - Lampen: 750 W**

TELAIO CON LAMPADE INFRAROSSI DA APPENDERE.

STRUCTURE A MUR AVEC LAMPES A INFRAROUGES.

FRAME WITH INFRARED LAMPS TO BE HANGED.

GESTELL MIT INFRAROTLAMPEN UM ZU AUFHAENGEN.



**PIA 4714 € 190,00**

DIMENSIONI ESTERNE - EXTERNAL DIMENSIONS LxPxH cm **45x68x25 h**  
 DIMENSIONS EXTERIEURES - AUBENABMESSUNGEN LxPxH cm

**1 lampada - lamp - lampe - Lampe: 250W**

**PIA 4715 € 260,00**

DIMENSIONI ESTERNE - EXTERNAL DIMENSIONS LxPxH cm **85x68x25 h**  
 DIMENSIONS EXTERIEURES - AUBENABMESSUNGEN LxPxH cm

**2 lampade - lamps - lampes - Lampen: 500W**

**PIA 4716 € 340,00**

DIMENSIONI ESTERNE - EXTERNAL DIMENSIONS LxPxH cm **128x68x25 h**  
 DIMENSIONS EXTERIEURES - AUBENABMESSUNGEN LxPxH cm

**3 lampade - lamps - lampes - Lampen: 750W**

**Piani caldi inox con lampade a raggi infrarossi - Stainless steel warming surfaces with infrared lamps**  
**Plateaux chauffés en inox avec lampes à infrarouges - Heizplatten aus rostfreiem stahl mit infrarotlampen**



-  PIANO CALDO CON LAMPADA A RAGGI INFRAROSSI. Struttura in acciaio inox. Termostato regolabile 30°-90°C, V230 50/60 Hz, 250W+250W.
-  WARMING SURFACE WITH INFRARED LAMP. Stainless steel frame. Adjustable thermostat 30°-90°C, V230 50/60Hz, 250W+250W.
-  PLATEAU CHAUFFANT AVEC LAMPE A INFRAROUGES. Structure in acier inox. Thermostat réglable 30°-90°C, V230 50/60 Hz, 250W+250W.
-  HEIZPLATTE MIT INFRAROTLAMPE. Gestell aus rostfreiem Stahl. Regulierbares Thermostat 30°-90°C, V230 50/60 Hz, 250W+250W.

**PCI 4718**

**€ 300,00**

DIMENSIONI ESTERNE - EXTERNAL DIMENSIONS LxPxH cm  
 DIMENSIONS EXTERIEURES - AUßENABMESSUNGEN LxPxH cm

**58x33x68 h**



-  PIANO CALDO CON 2 LAMPADE A RAGGI INFRAROSSI. Struttura in acciaio inox. Termostato regolabile 30°-90°C, V230 50/60 Hz, 250W+250W+250W.
-  WARMING SURFACE WITH 2 INFRARED LAMPS. Stainless steel frame. Adjustable thermostat 30°-90°C, V230 50/60Hz, 250W+250W+250W.
-  PLATEAU CHAUFFANT AVEC 2 LAMPES A INFRAROUGES. Structure en acier inox. Thermostat réglable 30°-90°C, V230 50/60 Hz, 250W+250W+250W.
-  HEIZPLATTE MIT 2 INFRAROTLAMPEN. Gestell aus rostfreiem Stahl. Regulierbares Thermostat 30°-90°C, V230 50/60 Hz, 250W+250W+250W.

**PCI 4718 D**

**€ 380,00**

DIMENSIONI ESTERNE - EXTERNAL DIMENSIONS LxPxH cm  
 DIMENSIONS EXTERIEURES - AUßENABMESSUNGEN LxPxH cm

**58x33x68 h**



Piano da 60x40  
 60x40 shelf  
 Etage 60x40  
 Platte 60x40

-  PIANO CALDO CON 2 LAMPADE A RAGGI INFRAROSSI. Struttura in acciaio inox. Termostato regolabile 30°-90°C, V230 50/60 Hz, 250W+250W+250W.
-  WARMING SURFACE WITH 2 INFRARED LAMPS. Stainless steel frame. Adjustable thermostat 30°-90°C, V230 50/60Hz, 250W+250W+250W.
-  PLATEAU CHAUFFANT AVEC 2 LAMPES A INFRAROUGES. Structure en acier inox. Thermostat réglable 30°-90°C, V230 50/60 Hz, 250W+250W+250W.
-  HEIZPLATTE MIT 2 INFRAROTLAMPEN. Gestell aus rostfreiem Stahl. Regulierbares Thermostat 30°-90°C, V230 50/60 Hz, 250W+250W+250W.

**PCI 4717**





**€ 390,00**

DIMENSIONI ESTERNE - EXTERNAL DIMENSIONS LxPxH cm  
 DIMENSIONS EXTERIEURES - AUßENABMESSUNGEN LxPxH cm

**60x40x68 h**

**Tavole calde da banco con lampade a raggi infrarossi - Lunch counters with infrared lamps**  
**Tables chauffées pour comptoir with infrared lamps - Heitzische - wasserbäder mit infrarotlampen**



-  CONTENITORE GN PER CONDIMENTO E MANTENIMENTO FRITTI. Struttura in acciaio inox. Lampada a raggi infrarossi W250 - V 230.
-  GN CONTAINER FOR SAUCES AND FRIED KEEPING. Stainless steel frame. Infrared lamp W250 - V 230 50/60 Hz.
-  CUVE GN POUR ASSAISONNEMENT ET MAINTIEN DES FRITURES. Structure in acier inox. Lampe infrarouges W250 - V 230 50/60 Hz.
-  GN BEHÄLTER FÜR WÜRZEN UND ERHALTUNG DES AUSGEBACKENES. Gestell aus rostfreiem Stahl. Infrarotlampe W250 - V 230 50/60 Hz.





**BI 4719**

**€ 340,00**

DIMENSIONI ESTERNE - EXTERNAL DIMENSIONS LxPxH cm  
 DIMENSIONS EXTERIEURES - AUßENABMESSUNGEN LxPxH cm

**60x33x68 h**



-  CONTENITORE GN CON 2 LAMPAD E A RAGGI INFRAROSSA.
-  GN CONTAINER WITH 2 INFRARED LAMPS.
-  CUVE GN AVEC 2 LAMPES A INFRAROUGES.
-  GN BEHAELTER MIT 2 INFRAROTLAMPEN .

**BI 4719 D**

**€ 430,00**

DIMENSIONI ESTERNE - EXTERNAL DIMENSIONS LxPxH cm  
 DIMENSIONS EXTERIEURES - AUßENABMESSUNGEN LxPxH cm



**60x33x68 h**



**Optionals**

- A 516** Vasca riscaldata per BI 4719 - Heated container for BI 4719  
 Cuve chauffée pour BI 4719 - Erwärmter Behälter für BI 4719

**€ 112,00 cad./each**

## **Mobiletti scaldapiatti - Plate warming cabinets** **Meubles chauffe-plats - Tellerwärm Möbel**

-  **MOBILETTI SCALDAPIATTI.** Struttura in acciaio inox. Termostato regolabile 30°-90°C, V230 50/60 Hz. Interruttore con spia luminosa. Ruote piroettanti. 1 ripiano intermedio. Interamente coibentato.
-  **PLATE WARMING CABINETS.** Structure made of stainless steel. Adjustable thermostat 30°-90°C. Main supply V230 50/60 Hz. Switch with warning light. Multidirectional wheels. 1 insulated shelf.

-  **MEUBLES CHAUFFE-PLATS.** Structure entièrement en acier inoxydable. Thermostat réglable 30°-90°C, V230 50/60 Hz. Interrupteur d'allumage avec lampe témoin. Roues pivotantes. 1 étagère isolée.
-  **TELLERWÄRM MÖBEL.** Gestell aus rostfreiem Stahl. Regulierbares Thermostat: 30°-90°C. Beschrückung V230 50/60 Hz. Einschalter mit Kontrollampe. Pirouettierende Rollen. 1 isolierte Etage.



|   |                   |
|---|-------------------|
| <b>MS 1860</b>  | <b>€ 940,00</b>   |
| DIMENSIONI ESTERNE LxPxH cm<br>EXTERNAL DIMENSIONS LxPxH cm<br>DIMENSIONS EXTERIEURES LxPxH cm<br>AUBENABMESSUNGEN LxPxH cm | <b>39x42x95 h</b> |
| <b>800 W</b>  |                   |
| Portata 60 piatti - Capacity 60 plates<br>Capacité 60 assiettes - Tragfähigkeit 60 Teller                                   |                   |

|   |                   |
|---|-------------------|
| <b>MS 1862</b>  | <b>€ 1.180,00</b> |
| DIMENSIONI ESTERNE LxPxH cm<br>EXTERNAL DIMENSIONS LxPxH cm<br>DIMENSIONS EXTERIEURES LxPxH cm<br>AUBENABMESSUNGEN LxPxH cm | <b>70x42x80 h</b> |
| <b>800 W</b>  |                   |
| Portata 100 piatti - Capacity 100 plates<br>Capacité 100 assiettes - Tragfähigkeit 100 Teller                               |                   |

|   |                   |
|---|-------------------|
| <b>MS 1866</b>  | <b>€ 1.240,00</b> |
| DIMENSIONI ESTERNE LxPxH cm<br>EXTERNAL DIMENSIONS LxPxH cm<br>DIMENSIONS EXTERIEURES LxPxH cm<br>AUBENABMESSUNGEN LxPxH cm | <b>70x42x95 h</b> |
| <b>800 W</b>  |                   |
| Portata 120 piatti - Capacity 120 plates<br>Capacité 120 assiettes - Tragfähigkeit 120 Teller                               |                   |



## Vetrine bar - Showcases for bar Vitrines pour bar - Bar-warmvitrinen

**IT** VETRINE RISCALDATE E NEUTRE. Costruite in acciaio inox. Fianchi e antine sui due fronti in plexiglass trasparente. Ripiano di base e intermedio estraibili. Riscaldamento a mezzo resistenza con regolazione della temperatura a mezzo termostato 30/90 °C, interruttore luminoso e lampada spia di funzionamento. Cavo con spina. Dispositivo di umidificazione.

**UK** WARMED DISPLAY-CASES AND NEUTRAL. Built in stainless steel. Front doors and sides in plexiglass. Heating by heater with thermostats removable bottom intermediate shelves 30/90 °C and signal lamp. On/off lighting switch: cable with and plug. Humidification device.



Vetrina riscaldata inox - 1 piano  
Warming display in stainless steel - 1 shelf  
Vitrine chauffant en acier inox - 1 étage  
Warmvitrine aus rostfreiem Stahl - 1 Etage

**VBR 4751 (L. 50) € 300,00**

LUNGA - LENGTH - LONGUEUR - LÄNGE cm **50**

DIMENSIONI ESTERNE - EXTERNAL DIMENSIONS LxPxH cm **50x35x25 h**  
DIMENSIONS EXTERIEURES - AUßENABMESSUNGEN LxPxH cm

**V 230 50/60 Hz 250 W**

**VBR 4781 (L. 85) € 390,00**

LUNGA - LENGTH - LONGUEUR - LÄNGE cm **85**

DIMENSIONI ESTERNE - EXTERNAL DIMENSIONS LxPxH cm **85x35x25 h**  
DIMENSIONS EXTERIEURES - AUßENABMESSUNGEN LxPxH cm

**V 230 50/60 Hz 400 W**

**FR** VITRINES CHAUFFÉES ET NEUTRES. Construction en acier inox. Cotés et portes sur les deux façades en plexiglass transparent. Chauffage par résistance bindée avec thermostat de réglage 30/90° C et lampe témoin. Interrupteur on/off. Cable avec prise. Humidificateur.

**DE** HEISSE UND NEUTRALE VITRINEN. Aufbau aus rostfreiem Stahl. Seiten und Türen aus durchsichtigem Plexiglass. Heizung durch Heizkörper mit Temperaturregelung durch thermostat 30/90 °C mit Kontrolleuchte. Ein/Aus Leuchtschalter; Kabel mit Stecker. Befeuchter.



Vetrina neutra inox - 1 piano  
Stainless steel displav - 1 shelf  
Vitrine en acier inox - 1 étage  
Vitrine aus rostfreiem Stahl - 1 Etage

**VBN 4751 (L. 50) € 180,00**

LUNGA - LENGTH - LONGUEUR - LÄNGE cm **50**

DIMENSIONI ESTERNE - EXTERNAL DIMENSIONS LxPxH cm **50x35x22 h**  
DIMENSIONS EXTERIEURES - AUßENABMESSUNGEN LxPxH cm

**VBN 4781 (L. 85) € 240,00**

LUNGA - LENGTH - LONGUEUR - LÄNGE cm **85**

DIMENSIONI ESTERNE - EXTERNAL DIMENSIONS LxPxH cm **85x35x22 h**  
DIMENSIONS EXTERIEURES - AUßENABMESSUNGEN LxPxH cm

### Optionals

**PRI 50** Piano intermedio riscaldato W. 250 - Middle shelf heated - Etagère moyenne chauffée - Erwärmte Zwischenplatte **€ 140,00**

**PRI 85** Piano intermedio riscaldato W. 250 - Middle shelf heated - Etagère moyenne chauffée - Erwärmte Zwischenplatte **€ 180,00**

**Vetrine bar - Showcases for bar**  
**Vitrines pour bar - Bar-warmvitrinen**



Vetrina riscaldata inox - 2 piano  
 Warming display in stainless steel - 2 shelf  
 Vitrine chauffant en acier inox - 2 étage  
 Warmvitrine aus rostfreiem Stahl - 2 Etage

|   |                   |
|---|-------------------|
| <b>VBR 4752 (L. 50)</b>   | <b>€ 400,00</b>   |
| LUNGA - LENGTH - LONGUEUR - LÄNGE cm  | <b>50</b>         |
| DIMENSIONI ESTERNE - EXTERNAL DIMENSIONS LxPxH cm<br>DIMENSIONS EXTERIEURES - AUßENABMESSUNGEN LxPxH cm | <b>50x35x40 h</b> |
| <b>V 230 50/60 Hz 250 W</b>   |                   |
| <b>VBR 4782 (L. 85)</b>   | <b>€ 510,00</b>   |
| LUNGA - LENGTH - LONGUEUR - LÄNGE cm  | <b>85</b>         |
| DIMENSIONI ESTERNE - EXTERNAL DIMENSIONS LxPxH cm<br>DIMENSIONS EXTERIEURES - AUßENABMESSUNGEN LxPxH cm | <b>85x35x40 h</b> |
| <b>V 230 50/60 Hz 400 W</b>   |                   |

Vetrina neutra inox - 2 piano  
 Stainless steel displav - 2 shelf  
 Vitrine en acier inox - 2 étage  
 Vitrine aus rostfreiem Stahl - 2 Etage

|   |                   |
|---|-------------------|
| <b>VBN 4752 (L. 50)</b>   | <b>€ 280,00</b>   |
| LUNGA - LENGTH - LONGUEUR - LÄNGE cm  | <b>50</b>         |
| DIMENSIONI ESTERNE - EXTERNAL DIMENSIONS LxPxH cm<br>DIMENSIONS EXTERIEURES - AUßENABMESSUNGEN LxPxH cm | <b>50x35x36 h</b> |
| <b>VBN 4782 (L. 85)</b>   | <b>€ 360,00</b>   |
| LUNGA - LENGTH - LONGUEUR - LÄNGE cm  | <b>85</b>         |
| DIMENSIONI ESTERNE - EXTERNAL DIMENSIONS LxPxH cm<br>DIMENSIONS EXTERIEURES - AUßENABMESSUNGEN LxPxH cm | <b>85x35x36 h</b> |





Vetrina riscaldata inox - 3 piano  
 Warming display in stainless steel - 3 shelf  
 Vitrine chauffant en acier inox - 3 étage  
 Warmvitrine aus rostfreiem Stahl - 3 Etage



|   |                   |
|---|-------------------|
| <b>VBR 4753 (L. 50)</b>   | <b>€ 490,00</b>   |
| LUNGA - LENGTH - LONGUEUR - LÄNGE cm  | <b>50</b>         |
| DIMENSIONI ESTERNE - EXTERNAL DIMENSIONS LxPxH cm<br>DIMENSIONS EXTERIEURES - AUßENABMESSUNGEN LxPxH cm | <b>50x35x54 h</b> |
| <b>V 230 50/60 Hz 400 W</b>   |                   |
| <b>VBR 4783 (L. 85)</b>   | <b>€ 630,00</b>   |
| LUNGA - LENGTH - LONGUEUR - LÄNGE cm  | <b>85</b>         |
| DIMENSIONI ESTERNE - EXTERNAL DIMENSIONS LxPxH cm<br>DIMENSIONS EXTERIEURES - AUßENABMESSUNGEN LxPxH cm | <b>85x35x54 h</b> |
| <b>V 230 50/60 Hz 400 W</b>   |                   |

Vetrina neutra inox - 3 piano  
 Stainless steel displav - 3 shelf  
 vitrine en acier inox - 3 étage  
 Vitrine aus rostfreiem Stahl - 3 Etage

|   |                   |
|---|-------------------|
| <b>VBN 4753 (L. 50)</b>   | <b>€ 370,00</b>   |
| LUNGA - LENGTH - LONGUEUR - LÄNGE cm  | <b>50</b>         |
| DIMENSIONI ESTERNE - EXTERNAL DIMENSIONS LxPxH cm<br>DIMENSIONS EXTERIEURES - AUßENABMESSUNGEN LxPxH cm | <b>50x35x50 h</b> |
| <b>VBN 4783 (L. 85)</b>   | <b>€ 470,00</b>   |
| LUNGA - LENGTH - LONGUEUR - LÄNGE cm  | <b>85</b>         |
| DIMENSIONI ESTERNE - EXTERNAL DIMENSIONS LxPxH cm<br>DIMENSIONS EXTERIEURES - AUßENABMESSUNGEN LxPxH cm | <b>85x35x50 h</b> |

## Vetrine bar - Showcases for bar Vitrines pour bar - Bar-warmvitrinen

-  Vetrina riscaldata ventilata da banco per alimenti. Con doppio vetro. Termostato manuale +30+90 °C.
-  Ventilated tabletop heated showcase for food. With double glass. Manual thermostat +30+90 °C.

-  Vitrine chaude de table ventilée pour aliments. Avec double verre. Thermostat manuel +30+90 °C.
-  Ventilierter Warmhaltevitruine fuer Speise. Tischgerät. Mit Doppelglas. Manuelles Thermostat +30+90 °C.



### **VPH 100**

**€ 565,00**

DIMENSIONI ESTERNE - EXTERNAL DIMENSIONS LxPxH cm  
DIMENSIONS EXTERIEURES - AUBENABMESSUNGEN LxPxH cm

**71x46x67 h**

**V 230 50/60 Hz 1100 W**

Vetrina riscaldata - 2 griglie  
Warming display - 2 grids  
Vitrine chauffant - 2 grilles  
Warmvitruine - 2 Roste

### **VPH 120**

**€ 750,00**

DIMENSIONI ESTERNE - EXTERNAL DIMENSIONS LxPxH cm  
DIMENSIONS EXTERIEURES - AUBENABMESSUNGEN LxPxH cm

**71x58x67 h**

**V 230 50/60 Hz 1100 W**

Vetrina riscaldata - 2 griglie  
Warming display - 2 grids  
Vitrine chauffant - 2 grilles  
Warmvitruine - 2 Roste

### **VPH 160**

**€ 890,00**



DIMENSIONI ESTERNE - EXTERNAL DIMENSIONS LxPxH cm  
DIMENSIONS EXTERIEURES - AUBENABMESSUNGEN LxPxH cm



**88x58x67 h**

**V 230 50/60 Hz 1100 W**

Vetrina riscaldata - 2 griglie  
Warming display - 2 grids  
Vitrine chauffant - 2 grilles  
Warmvitruine - 2 Roste

**Vitrine bar - Showcases for bar**  
**Vitrines pour bar - Bar-warmvitrinen**

-  **PORTA BriocheS - Croissants.** Piano in legno. Cupola in plx con antine apribili su 2 lati.
-  **PASTRY-HOLDER.** Wooden shelf. PLX cover with doors opening on both sides.

-  **PORTE-GÂTEAU.** Étagère en bois. Convercle en PLX avec portes ouvrables sur les deux côtés.
-  **GEBÄCKHALTER.** Etage aus Holz. Deckel aus PLX mit aufklappbaren Türen auf beiden Seiten.



**VL 4748 (L. 50) € 160,00**

DIMENSIONI ESTERNE - EXTERNAL DIMENSIONS LxPxH cm **50x35x21 h**  
 DIMENSIONS EXTERIEURES - AUßENABMESSUNGEN LxPxH cm

**VL 4749 (L. 85) € 190,00**

DIMENSIONI ESTERNE - EXTERNAL DIMENSIONS LxPxH cm **85x35x21 h**  
 DIMENSIONS EXTERIEURES - AUßENABMESSUNGEN LxPxH cm



WENGÉ

WENGÉ

**VL 4748W (L. 50) € 160,00**

DIMENSIONI ESTERNE - EXTERNAL DIMENSIONS LxPxH cm **50x35x21 h**  
 DIMENSIONS EXTERIEURES - AUßENABMESSUNGEN LxPxH cm

**VL 4749W (L. 85) € 190,00**

DIMENSIONI ESTERNE - EXTERNAL DIMENSIONS LxPxH cm **85x35x21 h**  
 DIMENSIONS EXTERIEURES - AUßENABMESSUNGEN LxPxH cm



LACCATO LUCIDO BIANCO - WHITE POLISH VARNISHED  
 BLANC LOQUÉ BRILLANT - GLANZWEISS LACKIERT

LACCATO LUCIDO BIANCO - WHITE POLISH VARNISHED  
 BLANC LOQUÉ BRILLANT - GLANZWEISS LACKIERT





**VL 4748B (L. 50) € 180,00**

DIMENSIONI ESTERNE - EXTERNAL DIMENSIONS LxPxH cm **50x35x21 h**  
 DIMENSIONS EXTERIEURES - AUßENABMESSUNGEN LxPxH cm

**VL 4749B (L. 85) € 210,00**

DIMENSIONI ESTERNE - EXTERNAL DIMENSIONS LxPxH cm **85x35x21 h**  
 DIMENSIONS EXTERIEURES - AUßENABMESSUNGEN LxPxH cm

## Vetrine bar - Showcases for bar Vitrines pour bar - Bar-warmvitrinen

-  Vetrinetta porta croissants e dolci. Struttura unica completamente in plexiglass con antine apribili sui due lati.
-  Vitrine porte-croissants et gâteaux. Structure unique en plexiglass avec portes s'ouvrant sur les deux côtés.
-  Show-case for croissants and cakes. Single plexiglass structure with doors opening on both sides.
-  Vitrine für Croissants und Kuchen. Einzelstruktur aus Plexiglass mit aufklappbaren Türen auf beiden Seiten.



VETRINA NEUTRA - 1 PIANO / DISPLAY - 1 SHELF  
VITRINE - 1 ÉTAGE / VITRINE - 1 ETAGE

**VBE 50 (L. 50)**

**€ 140,00**

DIMENSIONI ESTERNE - EXTERNAL DIMENSIONS LxPxH cm  
DIMENSIONS EXTERIEURES - AUßENABMESSUNGEN LxPxH cm

**50x35x18 h**



VETRINA NEUTRA - 1 PIANO / DISPLAY - 1 SHELF  
VITRINE - 1 ÉTAGE / VITRINE - 1 ETAGE

**VBE 85 (L. 85)**

**€ 185,00**

DIMENSIONI ESTERNE - EXTERNAL DIMENSIONS LxPxH cm  
DIMENSIONS EXTERIEURES - AUßENABMESSUNGEN LxPxH cm

**85x35x18 h**



## ***Carrelli portavassoi***



***Carrelli portavassoi rinforzati***  
***Carrelli portavassoi universali***  
***Carrelli portateglie GN***  
***Carrelli portateglie per pasticceria***  
***Carrelli portateglie GN rinforzati***  
***Carrelli portateglie per pasticceria rinforzati***

## ***Tray-holder trolley***



***Reinforced tray-holder trolley***  
***Universal tray-holder trolley***  
***GN pan trolley***  
***Tray rack trolley for bakeries***  
***Reinforced GN pan trolley***  
***Reinforced tray rack trolley for bakeries***

## ***Chariot porte-plateaux***



***Chariot porte-plateaux renforcés***  
***Chariot porte-plateaux universels***  
***Chariots portes-plaques GN***  
***Chariot porte-plaques à pâtisserie***  
***Chariot porte-plaques GN renforcés***  
***Chariot porte-plaques à pâtisserie renforcés***

## ***Tablettwagen***



***Verstärkte Tablettwagen***  
***Universale Tablettwagen***  
***GN Auflaufformenwagen***  
***Auflaufformen-Wagen für Konditoreibetriebe***  
***Verstärkte GN Auflaufformenwagen***  
***Verstärkte Auflaufformen-Wagen für Konditoreibetriebe***

## Carrelli portavassoi - Tray-holder trolley Chariot porte-plateaux - Tablettwagen

 Struttura in acciaio inox. Guide in acciaio inox. Ruote multidirezionali. paracolpi in gomma. Questi carrelli predisposti di serie per i vassoi GN 1/1 ( dim. mm 530 x 325) sono realizzati a richiesta per qualsiasi tipo di vassoio. Optional: vaschetta portabottiglie inox o ABS.

 Stainless steel structure. Stainless steel slide-ways. Multidirectional wheels. Rubber buffer. Serial trolleys are made for Gn 1/1 trays (530 x 325 mms) but we can make trolleys on request for any type of tray. Optional: stainless steel or ABS bottle-holder.



Portavassoi per n. 10 vassoi  
Tray holder for 10 trays  
Porte plateaux pour 10 plateaux  
Tablettwagen für n. 10 Tabletten

**CA 1450**

**€ 300,00**

DIMENSIONI ESTERNE - EXTERNAL DIMENSIONS LxPxH cm  
DIMENSIONS EXTERIEURES - AUßENABMESSUNGEN LxPxH cm

**38x62x175 h**



Portavassoi per n. 20 vassoi  
Tray holder for 20 trays  
Porte plateaux pour 20 plateaux  
Tablettwagen für n. 20 Tabletten

**CA 1460**

**€ 450,00**

DIMENSIONI ESTERNE - EXTERNAL DIMENSIONS LxPxH cm  
DIMENSIONS EXTERIEURES - AUßENABMESSUNGEN LxPxH cm

**74x62x175 h**



## Carrelli portavassoio - Tray-holder trolley Chariot porte-plateaux - Tablettwagen

Structure en acier inoxydable. Coulis en acier inoxydable. Roues pivotantes. Butoir engomme. Les chariots sont produits en série pour les plateaux GN 1/1 (dim. 530 x 325 mm) mais ils peuvent être réalisés pour n'importe quel type de plateau. Optionnel: cuvette porte-bouteilles en acier inoxydable / ou ABS.

Gestell und Schienen aus rostfreiem Stahl. Leichtlaufende Rollen. Gummipuffer. Diese Tablettwagen realisiert für Tabletten GN 1/1 (Abmessungen 530 x 325) sind können auf Anfrage für jede Art. von Tablett hergestellt sein. Sonderzubehör: Flaschenhalter aus rostfreiem Stahl oder aus ABS.



Portavassoio per n. 30 vassoio  
Tray holder for 30 trays  
Porte plateaux pour 30 plateaux  
Tablettwagen für n. 30 Tabletten

**CA 1470**

**€ 600,00**

DIMENSIONI ESTERNE - EXTERNAL DIMENSIONS LxPxH cm  
DIMENSIONS EXTERIEURES - AUßENABMESSUNGEN LxPxH cm

**110x62x175 h**



Bacinella portabottiglie in ABS  
ABS bottle-holder tank  
Cuvette porte-bouteilles en ABS  
Flaschenhalterschüssel aus ABS

**A 510**

**€ 43,00**

Bacinella portabottiglie in acciaio inox  
Stainless steel bottle-holder tank  
Cuvette porte-bouteilles en acier inoxydable  
Flaschenhalterschüssel aus rostfreiem Stahl

**A 500**

**€ 80,00**

### Optionals

**A 512** Ruote con freno - Wheels with catch  
Roues avec frein - Räder mit Bremse

**€ 7,00 cad./each**

**ATTENZIONE:** SPECIFICARE LE MISURE DEL VASSOIO ALL'ORDINE - **WARNING:** TRAY DIMENSIONS TO BE SPECIFIED WHEN ORDERING  
**ATTENTION:** DIMENSIONS DU PLATEAU À SPÉCIFIER LORS DE LA COMMANDE - **ACHTUNG:** BEI DER BESTELLUNG DIE TABLETTABMESSUNGEN MITTEILEN

## Carrelli portavassoi - Tray-holder trolley Chariot porte-plateaux - Tablettwagen

- 🇮🇹 Con pannelli laterali in perflex bianco o acciaio inox o wengè. A richiesta optional pannello posteriore.
- 🇬🇧 With side panels in white perflex or stainless steel or wengè. On demand back panel with surcharge.

- 🇫🇷 Avec panneaux latéraux en perflex blanc ou acier inox ou wengè. Sur demande panneau arrière avec supplément de prix.
- 🇩🇪 Mit Seitenplatten aus Perflex Weiss oder Edelstahl oder Wengè. Auf Anfrage, mit Aufpreis, Rückplatte.



Portavassoi per n. 10 vassoi. Pannellato laterale in perflex bianco.  
Tray holder for 10 trays. Side panels in white perflex.  
Porte plateaux pour 10 plateaux. Panneaux latéraux en perflex blanc.  
Tablettwagen für n. 10 Tabletten, seitlich getäfelt aus Perflex weiss.

**CA 1450P € 350,00**

Come sopra con pannelli laterali inox.  
See above with stainless steel lateral panels.  
Comme ci-dessus avec panneaux latéraux en inox.  
Wie oben mit Seitenplatten aus Edelstahl.

**CA 1450PI € 420,00**

Come sopra con pannelli laterali wengè.  
As above with wengè lateral panels.  
Comme ci-dessus avec panneaux latéraux en wengè.  
Wie oben mit Seitenplatten aus Wengè.

**CA 1450PW € 380,00**

DIMENSIONI ESTERNE - EXTERNAL DIMENSIONS LxPxH cm **38x62x175 h**  
DIMENSIONS EXTERIEURES - AUßENABMESSUNGEN LxPxH cm

Portavassoi per n. 20 vassoi Pannellato laterale in perflex bianco.  
Tray holder for 20 trays. Side panels in white perflex.  
Porte plateaux pour 20 plateaux. Panneaux latéraux en perflex blanc.  
Tablettwagen für n. 20 Tabletten, seitlich getäfelt aus Perflex weiss.

**CA 1460P € 500,00**

Come sopra con pannelli laterali inox.  
See above with stainless steel lateral panels.  
Comme ci-dessus avec panneaux latéraux en inox.  
Wie oben mit Seitenplatten aus Edelstahl.

**CA 1460PI € 570,00**

Come sopra con pannelli laterali wengè.  
As above with wengè lateral panels.  
Comme ci-dessus avec panneaux latéraux en wengè.  
Wie oben mit Seitenplatten aus Wengè.

**CA 1460PW € 530,00**

DIMENSIONI ESTERNE - EXTERNAL DIMENSIONS LxPxH cm **74x62x175 h**  
DIMENSIONS EXTERIEURES - AUßENABMESSUNGEN LxPxH cm

**A RICHIESTA OPTIONAL PANNELLO POSTERIOR - ON DEMAND BACK PANEL WITH SURCHARGE  
SUR DEMANDE PANNEAU ARRIÈRE AVEC SUPPLEMENT DE PRIX - AUF ANFRAGE, MIT AUFPREIS, RÜCKPLATTE**

**Carrelli portavassoio - Tray-holder trolley**  
**Chariot porte-plateaux - Tablettwagen**



Portavassoio per n. 30 vassoio. Pannellato laterale in perfix bianco.  
 Tray holder for 30 trays. Side panels in white perfix.  
 Porte plateaux pour 30 plateaux. Panneaux latéraux en perfix blanc.  
 Tablettwagen für n. 30 Tabletten, seitlich getäfelt aus Perfix weiss.

**CA 1470P € 660,00**

Come sopra con pannelli laterali inox.  
 See above with stainless steel lateralpanels.  
 Comme ci-dessus avec panneaux latéraux en inox.  
 Wie oben mit Seitenplatten aus Edelstahl.

**CA 1470PI € 720,00**

Come sopra con pannelli laterali wengè.  
 As above with wengè lateral panels.  
 Comme ci-dessus avec panneaux latéraux en wengé.  
 Wie oben mit Seitenplatten aus Wengé.

**CA 1470PW € 700,00**

DIMENSIONI ESTERNE - EXTERNAL DIMENSIONS LxPxH cm  
 DIMENSIONS EXTERIEURES - AUßENABMESSUNGEN LxPxH cm

**110x62x175 h**



Bacinella portabottiglie in ABS  
 ABS bottle-holder tank  
 Cuvette porte-bouteilles en ABS  
 Flaschenhalterschüssel aus ABS

**A 510 € 43,00**

Bacinella portabottiglie in acciaio inox  
 Stainless steel bottle-holder tank  
 Cuvette porte-bouteilles en acier inoxydable  
 Flaschenhalterschüssel aus rostfreiem Stahl

**A 500 € 80,00**

**Optionals**

**A 512** Ruote con freno - Wheels with catch  
 Roues avec frein - Räder mit Bremse **€ 7,00 cad./each**

**ATTENZIONE:** SPECIFICARE LE MISURE DEL VASSOIO ALL'ORDINE  
**WARNING:** TRAY DIMENSIONS TO BE SPECIFIED WHEN ORDERING  
**ATTENTION:** DIMENSIONS DU PLATEAU À SPÉCIFIER LORS DE LA COMMANDE  
**ACHTUNG:** BEI DER BESTELLUNG DIE TABLETTABMESSUNGEN MITTEILEN

**A RICHIESTA OPTIONAL PANNELLO POSTERIOR - ON DEMAND BACK PANEL WITH SURCHARGE**  
**SUR DEMANDE PANNEAU ARRIÈRE AVEC SUPPLEMENT DE PRIX - AUF ANFRAGE, MIT AUFPREIS, RÜCKPLATTE**

## Carrelli portavassoi rinforzati - Reinforced tray-holder trolley

### Chariot porte-plateaux renforcés - Verstärkte Tablettwagen

 Struttura in acciaio inox 25x25. Guide in acciaio inox sp. 1,2. Ruote multidirezionali, paracolpi in gomma. Questi carrelli predisposti in serie per i vassoi GN 1/1 (dim. mm 530x325) sono realizzati a richiesta per qualsiasi tipo di vassoio. Optional: vaschetta porta-bottiglie inox o ABS.

 Stainless steel structure. Stainless steel slide-ways. Multidirectional wheels. Rubber duffer. Serial trolleys are made for Gn 1/1 trays (530x325 mm) but we can make trolleys on request for any of tray. Optional: stainless steel or ABS bottle-holder.

 Structure en acier inoxydable. Coulis en acier inoxydable. Roues pivotantes. Butoir en gomme. Les chariots sont produits en serie pour les plateaux GN 1/1 (dim. 530x325 mm) mais ils peuvent être réalisés pour n'importe quel type de plateau. Optional: cuvette porte-bouteilles en acier inoxydable / ou ABS.

 Gestell und Schiegeleiten aus rostfreiem Stahl. Leichtlaufende Rollen. Gummipuffer. Diese Tablettwagen realisiert für Tabletten GN 1/1 (Abmessungen 530x325) sind können auf Anfrage für jede Art. von Tablett hergestellt sein. Sonderzubehör: Flaschenhalter aus rostfreiem Stahl oder aus ABS.



Portavassoi per n. 10 vassoi. - Tray holder for 10 trays.  
Porte plateaux pour 10 plateaux. - Tablettwagen für n. 10 Tabletten.

**CA 1451R** € 360,00

Con pannelli laterali in PERFEX bianco. - With sides in white PERFEX.  
Avec flancs en PERFEX blanc. - Mit Seiten aus weissen PERFEX.

**CA 1451RP** € 410,00

Con pannelli laterali in inox. - With sides in stainless steel.  
Avec flancs en acier inox. - Mit Seiten aus Edelstahl.

**CA 1451RPI** € 480,00

DIMENSIONI ESTERNE - EXTERNAL DIMENSIONS LxPxH cm **38x62x175 h**  
DIMENSIONS EXTERIEURES - AUßENABMESSUNGEN LxPxH cm

Portavassoi per n. 20 vassoi. - Tray holder for 20 trays.  
Porte plateaux pour 20 plateaux. - Tablettwagen für n. 20 Tabletten.

**CA 1461R** € 550,00

Con pannelli laterali in PERFEX bianco. - With sides in white PERFEX.  
Avec flancs en PERFEX blanc. - Mit Seiten aus weissen PERFEX.

**CA 1461RP** € 600,00

Con pannelli laterali in inox. - With sides in stainless steel.  
Avec flancs en acier inox. - Mit Seiten aus Edelstahl.

**CA 1461RPI** € 670,00

DIMENSIONI ESTERNE - EXTERNAL DIMENSIONS LxPxH cm **74x62x175 h**  
DIMENSIONS EXTERIEURES - AUßENABMESSUNGEN LxPxH cm

**A RICHIESTA OPTIONAL PANNELLO POSTERIOR - ON DEMAND BACK PANEL WITH SURCHARGE**  
**SUR DEMANDE PANNEAU ARRIÈRE AVEC SUPPLEMENT DE PRIX - AUF ANFRAGE, MIT AUFPREIS, RÜCKPLATTE**

**Carrelli portavassoi rinforzati - Reinforced tray-holder trolley**  
**Chariot porte-plateaux renforcés - Verstärkte Tablettwagen**



Portavassoi per n. 30 vassoi. - Tray holder for 30 trays.  
 Porte plateaux pour 30 plateaux. - Tablettwagen für n. 30 Tabletten.

**CA 1471R** € 750,00

Con pannelli laterali in PERFEX bianco. - With sides in white PERFEX.  
 Avec flancs en PERFEX blanc. - Mit Seiten aus weissen PERFEX.

**CA 1471RP** € 800,00

Con pannelli laterali in inox. - With sides in stainless steel.  
 Avec flancs en acier inox. - Mit Seiten aus Edelstahl.

**CA 1471RPI** € 870,00

DIMENSIONI ESTERNE - EXTERNAL DIMENSIONS LxPxH cm  
 DIMENSIONS EXTERIEURES - AUßENABMESSUNGEN LxPxH cm

**110x62x175 h**



Bacinella portabottiglie in ABS  
 ABS bottle-holder tank  
 Cuvette porte-bouteilles en ABS  
 Flaschenhalterschüssel aus ABS

**A 510** € 43,00

Bacinella portabottiglie in acciaio inox  
 Stainless steel bottle-holder tank  
 Cuvette porte-bouteilles en acier inoxydable  
 Flaschenhalterschüssel aus rostfreiem Stahl

**A 500** € 80,00

**Optionals**

**A 514** Ruote con freno - Wheels with catch  
 Roues avec frein - Räder mit Bremse € 9,00 cad./each

**ATTENZIONE:** SPECIFICARE LE MISURE DEL VASSOIO ALL'ORDINE  
**WARNING:** TRAY DIMENSIONS TO BE SPECIFIED WHEN ORDERING  
**ATTENTION:** DIMENSIONS DU PLATEAU À SPÉCIFIER LORS DE LA COMMANDE  
**ACHTUNG:** BEI DER BESTELLUNG DIE TABLETTABMESSUNGEN MITTEILEN

**A RICHIESTA OPTIONAL PANNELLO POSTERIOR - ON DEMAND BACK PANEL WITH SURCHARGE**  
**SUR DEMANDE PANNEAU ARRIÈRE AVEC SUPPLEMENT DE PRIX - AUF ANFRAGE, MIT AUFPREIS, RÜCKPLATTE**

## Carrelli portavassoi universali - Universal tray-holder trolley Chariot porte-plateaux universels - Universale Tablettwagen

 Struttura in acciaio inox. Guide in filo di acciaio cromato. Ruote multidirezionali. Paracolpi in gomma.

 Stainless steel structure. Slide-ways in chromium-plated steel wire. Multidirectional wheel. Rubber buffer.

 Structure en acier inoxydable. Coulisseaux en fil d'acier chromé. Roues pivotantes. Butoir en gomme.

 Gestell aus Edelstahl. Schienen aus verchromtem Stahl. Leichtlaufende Rollen. Gummipuffer.



Portavassoi per n. 10 vassoi. - Tray holder for 10 trays.  
Porte plateaux pour 10 plateaux. - Tablettwagen für n. 10 Tabletten.

**CA 1455**

**€ 280,00**

Come sopra con pannelli laterali in perfix.  
See above with perfix lateral panels.  
Comme ci dessus avec panneaux latéraux en perfix.  
Wie oben mit Seitenplatten aus Perfe.

**CA 1455P**

**€ 330,00**

Come sopra con pannelli laterali inox.  
See above with stainless steel lateral panels.  
Comme ci dessus avec panneaux latéraux en inox.  
Wie oben mit Seitenplatten aus Edelstahl.

**CA 1455PI**

**€ 400,00**

DIMENSIONI ESTERNE - EXTERNAL DIMENSIONS LxPxH cm  
DIMENSIONS EXTERIEURES - AUßENABMESSUNGEN LxPxH cm

**52x62x175 h**



Portavassoi per n. 20 vassoi. - Tray holder for 20 trays.  
Porte plateaux pour 20 plateaux. - Tablettwagen für n. 20 Tabletten.

**CA 1465**

**€ 420,00**

Come sopra con pannelli laterali in perfix.  
See above with perfix lateral panels.  
Comme ci dessus avec panneaux latéraux en perfix.  
Wie oben mit Seitenplatten aus Perfe.

**CA 1465P**

**€ 470,00**

Come sopra con pannelli laterali inox.  
See above with stainless steel lateral panels.  
Comme ci dessus avec panneaux latéraux en inox.  
Wie oben mit Seitenplatten aus Edelstahl.

**CA 1465PI**

**€ 540,00**

DIMENSIONI ESTERNE - EXTERNAL DIMENSIONS LxPxH cm  
DIMENSIONS EXTERIEURES - AUßENABMESSUNGEN LxPxH cm

**95x62x175 h**

### Optionals

**A 512** Ruote con freno - Wheels with catch - Roues avec frein - Räder mit Bremse

**€ 7,00 cad./each**

## Carrelli portavassoio universali - Universal tray-holder trolley Chariot porte-plateaux universels - Universale Tablettwagen



Portavassoio per n. 30 vassoio. - Tray holder for 30 trays.  
Porte plateaux pour 30 plateaux. - Tablettwagen für n. 30 Tabletten.

**CA 1475** € 550,00

Come sopra con pannelli laterali in perfix.  
See above with perfix lateral panels.  
Comme ci dessus avec panneaux latéraux en perfix.  
Wie oben mit Seitenplatten aus Perfe.

**CA 1475P** € 600,00

Come sopra con pannelli laterali inox.  
See above with stainless steel lateral panels.  
Comme ci dessus avec panneaux latéraux en inox.  
Wie oben mit Seitenplatten aus Edelstahl.

**CA 1475PI** € 670,00

DIMENSIONI ESTERNE - EXTERNAL DIMENSIONS LxPxH cm  
DIMENSIONS EXTERIEURES - AUßENABMESSUNGEN LxPxH cm **138x62x175 h**

- Portateghe da banco per teglie tonde da cm. 26 a 32. Confezione minima 4 pz.
- Tabletop rack for round baking pans from 26 to 32 cm. Minimum package 4 pcs.
- Porte-plaques de table pour plaques rondes de 26 à 32 cm. Paquet minimum 4 pièces.
- Tischblechstaender fuer runde Bleche vom 26 bis 32 cm. Minimum Verpackung 4 St.



**PT 15**

€ 58,00

DIMENSIONI ESTERNE - EXTERNAL DIMENSIONS LxPxH cm  
DIMENSIONS EXTERIEURES - AUßENABMESSUNGEN LxPxH cm **38x29x67 h**

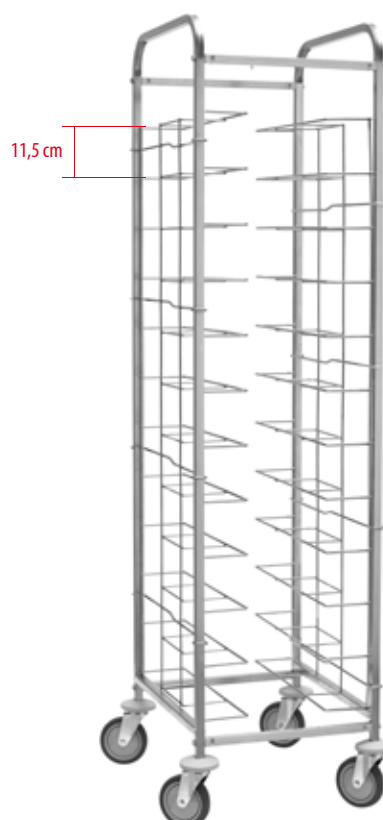

**NEW**

Portavassoio per n. 12 vassoio. - Tray holder for 12 trays.  
Porte plateaux pour 12 plateaux. - Tablettwagen für n. 12 Tabletten.

**CA 1455 V12** € 340,00

DIMENSIONI ESTERNE - EXTERNAL DIMENSIONS LxPxH cm  
DIMENSIONS EXTERIEURES - AUßENABMESSUNGEN LxPxH cm **52x62x185 h**

**A RICHIESTA OPTIONAL PANNELLO POSTERIOR - ON DEMAND BACK PANEL WITH SURCHARGE  
SUR DEMANDE PANNEAU ARRIERE AVEC SUPPLEMENT DE PRIX - AUF ANFRAGE, MIT AUFPREIS, RÜCKPLATTE**

## Carrelli portateglie GN - GN pan trolley

### Chariots portes-plaques GN - GN Auflaufformenwagen

🇮🇹 Struttura in acciaio inox. Guide in acciaio inox. Ruote multidirezionali. Paracolpi in gomma. Carrelli predisposti di serie per teglie GN 2/1. A richiesta per altre misure.

🇬🇧 Stainless steel structure. Stainless steel slide-ways. Multidirectional wheels. Rubber buffer. Serial trolley are made for GN 2/1 boards, but we can make trolleys on request for any type of board.

🇫🇷 Structure en acier inoxydable. Coulisseaux en acier inoxydable. Roues pivotantes. Butoir en gomme. Les chariots sont produits en série pour plaques GN 2/1, mais peuvent être réalisés à la demande pour n'importe quel type de plaque.

🇩🇪 Gestell und Schienen aus rostfreiem Stahl. Leichtlaufende Rollen. Gummipuffer. Diese backformenwagen GN 2/1 können auf Anfrage für jede Art von Backform hergestellt sein.



**CA 1477**

**€ 390,00**

PORTATA - CAPACITY  
CAPACITÉ - TRAGFÄHIGKEIT

**8 GN 2/1**  
0/OR/OU/ODER  
**16 GN 1/1**

DIMENSIONI ESTERNE - EXTERNAL DIMENSIONS LxPxH cm  
DIMENSIONS EXTERIEURES - AUßENABMESSUNGEN LxPxH cm

**65x76x94 h**

**CA 1476**

**€ 420,00**

PORTATA - CAPACITY  
CAPACITÉ - TRAGFÄHIGKEIT

**14 GN 2/1**  
0/OR/OU/ODER  
**28 GN 1/1**

DIMENSIONI ESTERNE - EXTERNAL DIMENSIONS LxPxH cm  
DIMENSIONS EXTERIEURES - AUßENABMESSUNGEN LxPxH cm

**65x76x182 h**

### Optionals

**A 512** Ruote con freno - Wheels with catch - Roues avec frein - Räder mit Bremse

**€ 7,00 cad./each**



## Carrelli portateglie GN - GN pan trolley Chariots portes-plaques GN - GN Auflaufformwagen

🇮🇹 Struttura in acciaio inox. Guide in acciaio inox. Ruote multidirezionali. Paracolpi in gomma. Carrelli predisposti di serie per teglie GN 1/1. A richiesta per altre misure.

🇬🇧 Stainless steel structure. Stainless steel slide-ways. Multidirectional wheels. Rubber buffer. Serial trolley are made for GN 1/1 boards, but we can make trolleys on request for any type of board.

🇫🇷 Structure en acier inoxydable. Coulisseaux en acier inoxydable. Roues pivotantes. Butoir en gomme. Les chariots sont produits en serie pour plaques GN 1/1, mais peuvent être réalisés à la demande pour n'importe quel type de plaque.

🇩🇪 Gestell und Schienen aus rostfreiem Stah. Leichtlaufende Rollen. Gummipuffer. Diese Backformwagen GN 1/1 Können auf Anfrage für jede Art von Backform hergestellt sein.



**CA 1478**

**€ 360,00**

PORTATA - CAPACITY  
CAPACITÉ - TRAGFÄHIGKEIT

**8 GN 1/1**

DIMENSIONI ESTERNE - EXTERNAL DIMENSIONS LxPxH cm  
DIMENSIONS EXTERIEURES - AUßENABMESSUNGEN LxPxH cm

**45x66x94 h**



**CA 1479**

**€ 370,00**

PORTATA - CAPACITY  
CAPACITÉ - TRAGFÄHIGKEIT

**14 GN 1/1**

DIMENSIONI ESTERNE - EXTERNAL DIMENSIONS LxPxH cm  
DIMENSIONS EXTERIEURES - AUßENABMESSUNGEN LxPxH cm

**45x66x182 h**

### Optionals

**A 512** Ruote con freno - Wheels with catch - Roues avec frein - Räder mit Bremse

**€ 7,00 cad./each**

## Carrelli portateglie GN rinforzati - Reinforced GN pan trolley

## Chariot porte-plaques GN renforcés - Verstärkte GN Auflaufformenwagen

- Struttura in acciaio inox 25x25. Guide in acciaio inox sp. 1,2. Ruote multidirezionali, paracolpi in gomma.
- Stainless steel structure. Stainless steel slide-ways. Multidirectional wheels. Rubber duffer. Serial trolleys are made for Gn 2/1 boards, but we can make trolleys on request for any type of board.

- Structure en acier inoxydable. Coulis en acier inoxydable. Roues pivotantes. Butoir en gomme. Les chariots sont produits en serie pour plateaux GN 2/1, mais peuvent être realises à la demande pour n'emport quel type de plaque.
- Gestell und Schiegegen aus rostfreiem Stahl. Leichtlaufende Rollen. Gummipuffer. Diese backformwagen GN 2/1 Können auf Anfrage für jede Art von Backform horgestellt sein.



### CA 1489R

€ 510,00

PORTATA - CAPACITY  
CAPACITÉ - TRAGFÄHIGKEIT

14 GN 1/1

DIMENSIONI ESTERNE - EXTERNAL DIMENSIONS LxPxH cm  
DIMENSIONS EXTERIEURES - AUßENABMESSUNGEN LxPxH cm

46x62x182 h

### CA 1486R

€ 570,00

PORTATA - CAPACITY  
CAPACITÉ - TRAGFÄHIGKEIT

14 GN 2/1  
0/OR/OU/ODER  
28 GN 1/1

DIMENSIONI ESTERNE - EXTERNAL DIMENSIONS LxPxH cm  
DIMENSIONS EXTERIEURES - AUßENABMESSUNGEN LxPxH cm

66x72x182 h

### Optionals

A 514 Ruote con freno - Wheels with catch - Roues avec frein - Räder mit Bremse

€ 9,00 cad./each

## Carrelli portateglie per pasticceria rinforzati - Reinforced tray rack trolley for bakeries - Chariot porte-plaques à pâtisserie renforcés - Verstärkte Auflaufformen-Wagen für Konditoreibetriebe

- Per 14 teglie da 60x40 (su richiesta per qualsiasi teglia). Intera- mente in acciaio inox. Ruote multidirezionali.
- For 14 boards size 60x40 (on request for any board). Entirely stainless steel. Multidirectional wheels.
- Pour 14 plaques dim. 60x40 (sur demande pour n'importe quelle plaque). Entièrement en acier inoxydable Roues pivotantes.
- Für 14 Backformen Abmessungen 60x40 (auf Anfrage für Jede Form). Komplett aus rostfreiem Stahl. Leichtlaufende Rollen.



**CA 1492R**

**€ 550,00**

DIMENSIONI ESTERNE - EXTERNAL DIMENSIONS LxPxH cm  
DIMENSIONS EXTERIEURES - AUßENABMESSUNGEN LxPxH cm

**53x72x182 h**

### Optionals

**A 514** Ruote con freno - Wheels with catch  
Roues avec frein - Räder mit Bremse

**€ 9,00 cad./each**



Teglia Blurex - Blurex tray - Plaque Blurex - Blurex Form

**AV 4947**

**€ 18,00**

DIMENSIONI ESTERNE - EXTERNAL DIMENSIONS LxPxH cm  
DIMENSIONS EXTERIEURES - AUßENABMESSUNGEN LxPxH cm

**60x30x2 h**

**AV 4937**

**€ 18,00**

DIMENSIONI ESTERNE - EXTERNAL DIMENSIONS LxPxH cm  
DIMENSIONS EXTERIEURES - AUßENABMESSUNGEN LxPxH cm

**60x40x2 h**



Teglia alluminata - Aluminized pan - Pan aluminisé - Aluminisierte pan

**AV 4950**

**€ 18,00**

DIMENSIONI ESTERNE - EXTERNAL DIMENSIONS LxPxH cm  
DIMENSIONS EXTERIEURES - AUßENABMESSUNGEN LxPxH cm

**60x30x2 h**

**AV 4940**

**€ 18,00**

DIMENSIONI ESTERNE - EXTERNAL DIMENSIONS LxPxH cm  
DIMENSIONS EXTERIEURES - AUßENABMESSUNGEN LxPxH cm

**60x40x2 h**



Teglia in alluminio - Aluminium tray  
Plateau en aluminium - Aluminiumschale

**AV 4980**





**€ 20,00**





DIMENSIONI ESTERNE - EXTERNAL DIMENSIONS LxPxH cm  
DIMENSIONS EXTERIEURES - AUßENABMESSUNGEN LxPxH cm

**60x40x2 h**

## Carrelli portateglie per pasticceria - Tray rack trolley for bakeries

## Chariot porte-plaques à pâtisserie - Auflaufformen-Wagen für Konditoreibetriebe

-  Interamente in acciaio inox. Ruote multidirezionali. Per 20 teglie.
-  Entirely stainless steel. Multidirectional wheels. For 20 boards.
-  Entièrement en acier inoxydable. Roues pivotantes. Pour 20 plaques.
-  Komplett aus rostfreiem Stahl. Leichtlaufende Rollen. Für 20 Backformen.

-  Interamente in acciaio inox. Ruote multidirezionali. Per 40 teglie.
-  Entirely stainless steel. Multidirectional wheels. For 40 boards.
-  Entièrement en acier inoxydable. Roues pivotantes. Pour 40 plaques.
-  Komplett aus rostfreiem Stahl. Leichtlaufende Rollen. Für 40 Backformen.



**CA 1480**

**€ 380,00**

DIMENSIONI ESTERNE - EXTERNAL DIMENSIONS LxPxH cm  
DIMENSIONS EXTERIEURES - AUßENABMESSUNGEN LxPxH cm

**51x47x177 h**

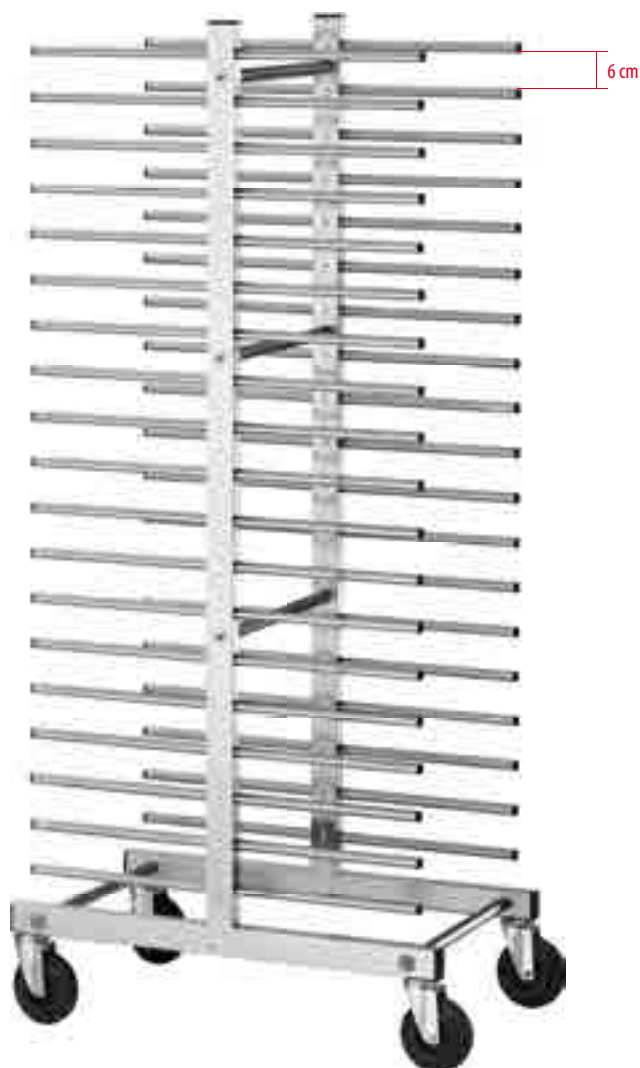

**CA 1480D**

**€ 530,00**

DIMENSIONI ESTERNE - EXTERNAL DIMENSIONS LxPxH cm  
DIMENSIONS EXTERIEURES - AUßENABMESSUNGEN LxPxH cm

**51x80x177 h**

### Optionals

**A 512** Ruote con freno - Wheels with catch - Roues avec frein - Räder mit Bremse

**€ 7,00 cad./each**

## Carrelli portateglie per pasticceria - Tray rack trolley for bakeries Chariot porte-plaques à pâtisserie - Auflaufformen-Wagen für Konditoreibetriebe

- 🇮🇹 Interamente in acciaio inox. Ruote multidirezionali. Per 14 teglie da 60 x 40 (su richiesta per qualsiasi teglia).
- 🇬🇧 Entirely stainless steel. Multidirectional wheels. For 14 boards size 60 x 40 (on request for any board).



Per 14 teglie da 60x40  
For 14 boards size 60x40  
Pour 14 plaques dim. 60x40  
Für 14 Backformen Abmessungen 60x40

**CA 1482**

**€ 400,00**

Portata 20 teglie 60x40, distanza fra le guide cm. 6.  
Capacity 20 pans 60x40, distance between the runners cm. 6.  
capacite 20 plaques 60x40, distance entre les glissieres 6 cm.  
Tragfaehigkeit 20 backformen 60x40, abstand zwischen die schienen 6 cm.

**CA 1482 T20**

**€ 500,00**

DIMENSIONI ESTERNE - EXTERNAL DIMENSIONS LxPxH cm  
DIMENSIONS EXTERIEURES - AUßENABMESSUNGEN LxPxH cm

**52x72x182 h**

- 🇫🇷 Entièrement en acier inoxydable. Roues pivotantes. Pour 14 plaques dim. 60 x 40 (sur demande pour n'importe quelle plaque).
- 🇩🇪 Komplet aus rostfreiem Stahl. Leichtlaufende Rollen. Für 14 Backformen Abmessungen 60 x 40 (auf Anfrage für Jede Form).



Per 8 teglie da 60x40  
For 8 boards size 60x40  
Pour 8 plaques dim. 60x40  
Für 8 Backformen Abmessungen 60x40

**CA 1483**

**€ 365,00**

DIMENSIONI ESTERNE - EXTERNAL DIMENSIONS LxPxH cm  
DIMENSIONS EXTERIEURES - AUßENABMESSUNGEN LxPxH cm

**52x72x94 h**

Teglie: 8 pz. 80x60 / 16 pz. 60x40  
Boards: 8 pcs. 80x60 / 16 pcs. 60x40  
Plaques: 8 pcs. 80x60 / 16 pcs. 60x40  
Backformen: 8 Stk. 80x60 / 16 Stk. 60x40

**CA 1493**

**€ 400,00**

DIMENSIONI ESTERNE - EXTERNAL DIMENSIONS LxPxH cm  
DIMENSIONS EXTERIEURES - AUßENABMESSUNGEN LxPxH cm

**85x65x94 h**

### Optionals

**A 512** Ruote con freno - Wheels with catch - Roues avec frein - Räder mit Bremse

**€ 7,00 cad./each**



## ***Carrelli portapiatti, vassoi e teglie***

*Carrello scolapiatti-bicchieri*  
*Scolapiatti e bicchieri da muro*  
*Cestelli per lavastoviglie 50x50*  
*Portacestelli per lavastoviglie*  
*Carrello portapiatti antipasti refrigerato a ventilazione*  
*Carrello portapiatti antipasti riscaldato a resistenza W1600*  
*Carrelli per ritiro, distribuzione e stoccaggio vassoi, piatti, tazze, ecc.*  
*Carrello portapiatti*

## ***Dish, tray and pan carts***

*Dish and glass drying rack trolley*  
*Dish and glass drying racks on wall*  
*Racks for dishwashing machines*  
*Dish washer tray trolley*  
*Ventilated refrigeration trolley*  
*Heated trolley for hors d'oeuvre dishes with heating element W1600*  
*Trays, dishes, cups stacking and distribution trolleys. Stainless steel framework*  
*Dish trolley*





## ***Chariot porte-assiettes, plateaux et plaques***





*Chariot égouttoir à vaisselle - verres*  
*Egouttier pour assiettes et verres à mur*  
*Paniers pour lave-vaisselle*  
*Porte-paniers pour lave-vaisselle*  
*Chariot porte-assiettes pour hors d'oeuvre réfrigéré à ventilation*  
*Chariot porte-assiettes pour hors d'oeuvre chauffé avec résistance W1600*  
*Chariots pour distribution et rangement de plateaux, assiettes et tasses*  
*Chariots porte-assiettes*

## ***Geschirrwagen, Tablettts und Auflaufformen Tellerwagen***

*Abtropfwagen für Geschirr und Gläser*  
*Abtropfwagen für Geschirr und Gläser für Wand*  
*Körbe für Spülmaschine*  
*Korbhalter für Spülmaschinen*  
*Gekühlter tellerwagen für vorspeiseteller mit lüftung*  
*Erwaermter tellerhalterwagen für vorspeiseteller mit thermoelement W1600*  
*Wagen für Abdecken, Verteilung und Lagerung der Servierbretter, Teller ecc*  
*Geschirrwagen*

**Carrelli portapiatti, vassoi e teglie - Dish, tray and pan carts - Chariot porte-assiettes, plateaux et plaques - Geschirrwagen, Tablett und Auflaufformen Tellerwagen.**

-  PORTAPIATTI DA BANCO.
-  LUNCH COUNTER DISH HOLDER.
-  PORTE-ASSIETTES DE TABLE.
-  GESCHIRRWAGEN FÜR TISCH.

-  PORTAPIATTI DA MURO.
-  WALL PLATE HOLDER.
-  PORTE-ASSIETTES À MUR.
-  WAND-GESCHIRRWAGEN.



Griglia verniciata per piatti 18/23. Portata 48 piatti. Girevole da banco.  
Painted grid. Capacity 48 plates. Revolving for table.  
Grille peinte. Capacité 48 plats. Pivotant pour table.  
Lackierter Rost. Tragfähigkeit 48 Teller. Drehbar für Tisch.

**CA 1439 B**

**€ 325,00**

Griglia cromata per piatti 18/23. Portata 48 piatti. Girevole da banco.  
Chromed grid. Capacity 48 plates. Revolving for table.  
Grille chromée. Capacité 48 plats. Pivotant pour table.  
Verchromter Rost. Tragfähigkeit 48 Teller. Drehbar für Tisch.

**CA 1440 B**

**€ 335,00**

DIMENSIONI ESTERNE - EXTERNAL DIMENSIONS LxPxH cm  
DIMENSIONS EXTERIEURES - AUßENABMESSUNGEN LxPxH cm

**60x60x100 h**

Griglia verniciata per piatti 25/31. Portata 48 piatti. Girevole da banco.  
Painted grid for dishes 25/31. Capacity 48 plates. Revolving for table.  
Grille peinte pour assiettes 25/31. Capacité 48 plats. Pivotant pour table.  
Lackierter Rost für Teller 25/31. Tragfähigkeit 48 Teller. Drehbar für Tisch.

**CA 1439 BG**

**€ 330,00**

Griglia cromata per piatti 25/31. Portata 48 piatti. Girevole da banco.  
Chromed grid for dishes 25/31. Capacity 48 plates. Revolving for table.  
Grille chromée pour assiettes 25/31. Capacité 48 plats. Pivotant pour table.  
Verchromter Rost für Teller 25/31. Tragfähigkeit 48 Teller. Drehbar für Tisch.

**CA 1440 BG**

**€ 355,00**

DIMENSIONI ESTERNE - EXTERNAL DIMENSIONS LxPxH cm  
DIMENSIONS EXTERIEURES - AUßENABMESSUNGEN LxPxH cm

**70x70x100 h**



Portata 12 piatti. Da parete per piatti 18/23  
Capacity 12 plates. For wall  
Capacité 12 plats. Mural  
Tragfähigkeit 12 Teller. Für Wand

**CA 1439 P**

**€ 75,00**

DIMENSIONI ESTERNE - EXTERNAL DIMENSIONS LxPxH cm  
DIMENSIONS EXTERIEURES - AUßENABMESSUNGEN LxPxH cm

**42x20x90 h**



## Carrelli portapiatti, vassoi e teglie - Dish, tray and pan carts - Chariot porte-assiettes, plateaux et plaques - Geschirrwagen, Tablett und Auflaufformen Tellerwagen.

 **CARRELLI PORTAPIATTI.** Struttura in acciaio plastificato con base in lamiera antipolvere. Griglie plastificate o cromate. Maniglie per conduzione carrello. Ruote Ø 125 di cui due con freno.

 **DISH CARTS.** Structure in plastic-coated steel with base in dust-proof sheet metal. Racks in rilsan plastic-coated or chromed steel. Side handles to steer trolley. Wheels diam. 125, two with brake.

 **CHARIOTS PORTE-ASSIETTES.** Structure en acier plastifié avec base en tôle antipoussière. Grilles plastifiées Rilsan ou chromées. Poignées de conduite du chariot. Roulettes Ø 125 dont deux, à frein.

 **GESCHIRRWAGEN.** Struktur aus plastifiziertem Stahl mit Basis aus Staubabweisendem Blech. Roste mit Rilsan plastifiziert oder verchromt. Griffe zum Fahren des Wagens. Räder Ø 125, davon zwei mit Bremse.

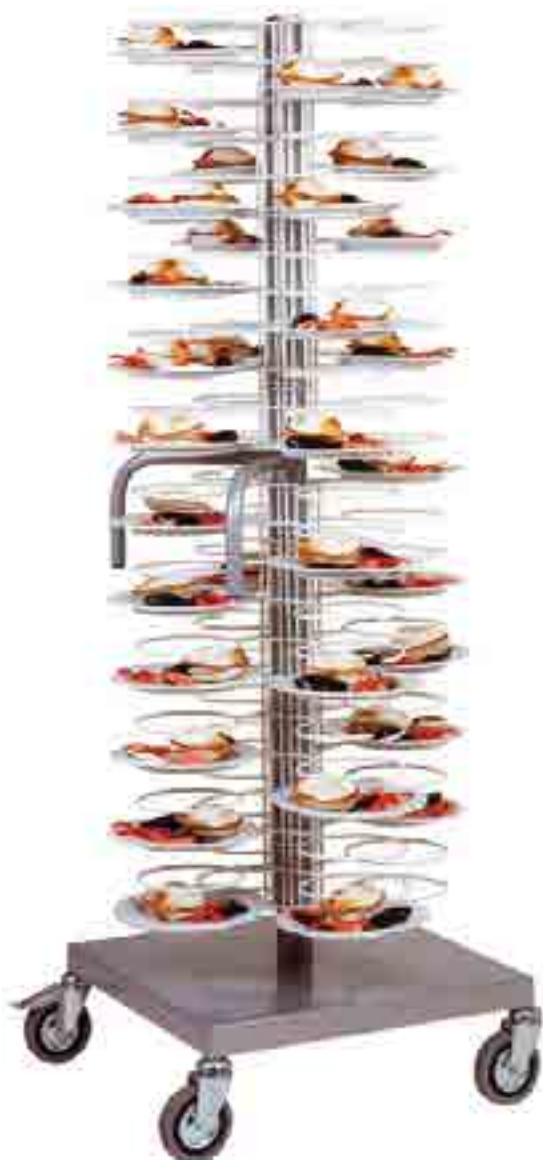

Portata 96 piatti. Griglie verniciate per piatti 18/23

Capacity 96 plates. Polished racks

Capacité 96 plats. Grilles vernies

96 Teller. Lackierte Gitter Tragfähigkeit

**CA 1439**

**€ 560,00**

Portata 96 piatti. Griglie cromate per piatti 18/23

Capacity 96 plates. Chromium-plated racks

Capacité 96 plats. Grilles chromées

Tragfähigkeit 96 Teller. Verchromte Roste

**CA 1440**

**€ 580,00**

DIMENSIONI ESTERNE - EXTERNAL DIMENSIONS LxPxH cm

DIMENSIONS EXTERIEURES - AUBENABMESSUNGEN LxPxH cm

**60x60x175 h**

Portata 96 piatti. Griglie verniciate per piatti 25-31

Capacity 96 plates. Polished racks

Capacité 96 plats. Grilles vernies

Tragfähigkeit 96 Teller. Lackierte Gitter

**CA 1439 G**

**€ 590,00**

Portata 96 piatti. Griglie cromate per piatti 25-31

Capacity 96 plates. Chromium-plated racks

Capacité 96 plats. Grilles chromées

Tragfähigkeit 96 Teller. Verchromte Roste

**CA 1440 G**

**€ 620,00**

DIMENSIONI ESTERNE - EXTERNAL DIMENSIONS LxPxH cm

DIMENSIONS EXTERIEURES - AUBENABMESSUNGEN LxPxH cm

**70x70x175 h**

### Optionals

**A 410**

**CA1439-40**

Copertura in PVC con 4 cerniere - PVC lid with 4 hinges - Couverture en PVC avec 4 charnières - PVC-Abdeckung mit 4 Scharnieren

**€ 200,00**

**A 420**

**CA 1439G-40G**

Copertura in PVC con 4 cerniere - PVC lid with 4 hinges - Couverture en PVC avec 4 charnières - PVC-Abdeckung mit 4 Scharnieren

**€ 230,00**

**Carrelli portapiatti, vassoi e teglie - Dish, tray and pan carts - Chariot porte-assiettes, plateaux et plaques - Geschirrwagen, Tablets und Auflaufformen Tellerwagen.**

**NEW**

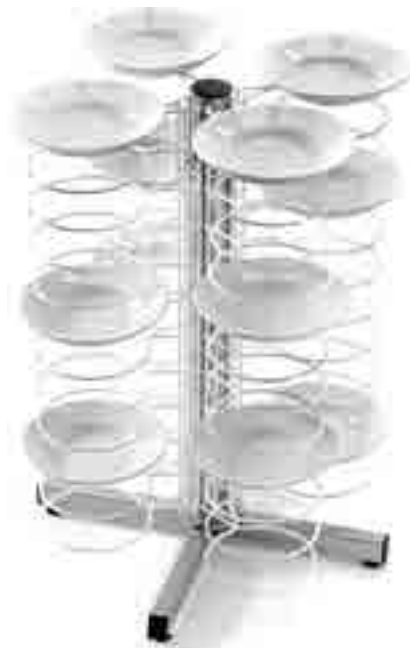

Griglia verniciata per piatti 18/23. Portata 48 piatti. da banco  
Painted grid. Capacity 48 plates. for table  
Grille peinte. Capacité 48 plats. pour table  
Lackierter Rost. Tragfähigkeit 48 Teller. für Tisch

**CA 1435**

**€ 275,00**

Griglia cromata per piatti 18/23. Portata 48 piatti. da banco  
Chromed grid. Capacity 48 plates. for table  
Grille chromée. Capacité 48 plats. pour table  
Verchromter Rost. Tragfähigkeit 48 Teller. für Tisch

**CA 1436**

**€ 280,00**

DIMENSIONI ESTERNE - EXTERNAL DIMENSIONS LxPxH cm  
DIMENSIONS EXTERIEURES - AUßENABMESSUNGEN LxPxH cm

**60x60x83 h**

Griglia verniciata per piatti 25/31. Portata 48 piatti. da banco  
Painted grid for dishes 25/31. Capacity 48 plates. for table  
Grille peinte pour assiettes 25/31. Capacité 48 plats. pour table  
Lackierter Rost für Teller 25/31. Tragfähigkeit 48 Teller. für Tisch

**CA 1435 G**

**€ 285,00**

Griglia cromata per piatti 25/31. Portata 48 piatti. da banco  
Chromed grid for dishes 25/31. Capacity 48 plates. for table  
Grille chromée pour assiettes 25/31. Capacité 48 plats. pour table  
Verchromter Rost für Teller 25/31. Tragfähigkeit 48 Teller. für Tisch

**CA 1436 G**

**€ 300,00**

DIMENSIONI ESTERNE - EXTERNAL DIMENSIONS LxPxH cm  
DIMENSIONS EXTERIEURES - AUßENABMESSUNGEN LxPxH cm

**70x70x83 h**

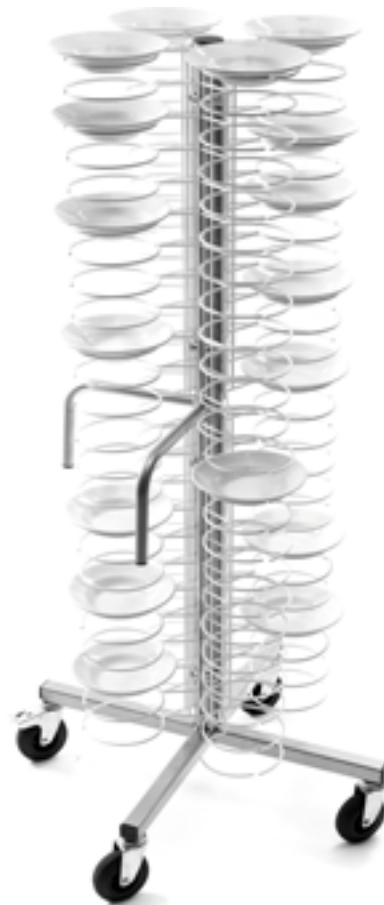

Portata 96 piatti. Griglie verniciate per piatti 18/23  
Capacity 96 plates. Polished racks  
Capacité 96 plats. Grilles vernies  
96 Teller. Lackierte Gitter Tragfähigkeit

**CA 1437**

**€ 460,00**

Portata 96 piatti. Griglie cromate per piatti 18/23  
Capacity 96 plates. Chromium-plated racks  
Capacité 96 plats. Grilles chromées  
Tragfähigkeit 96 Teller. Verchromte Roste

**CA 1438**

**€ 480,00**

DIMENSIONI ESTERNE - EXTERNAL DIMENSIONS LxPxH cm  
DIMENSIONS EXTERIEURES - AUßENABMESSUNGEN LxPxH cm

**60x60x173 h**

Portata 96 piatti. Griglie verniciate per piatti 25-31  
Capacity 96 plates. Polished racks  
Capacité 96 plats. Grilles vernies  
Tragfähigkeit 96 Teller. Lackierte Gitter

**CA 1437 G**

**€ 490,00**

Portata 96 piatti. Griglie cromate per piatti 25-31  
Capacity 96 plates. Chromium-plated racks  
Capacité 96 plats. Grilles chromées  
Tragfähigkeit 96 Teller. Verchromte Roste

**CA 1438 G**

**€ 520,00**

DIMENSIONI ESTERNE - EXTERNAL DIMENSIONS LxPxH cm  
DIMENSIONS EXTERIEURES - AUßENABMESSUNGEN LxPxH cm

**70x70x173 h**



**ATTENZIONE!**  
CONFEZIONAMENTO IN KIT  
PER RISPARMIO COSTI TRASPORTO

**ATTENTION!**  
PACKING IN SET FOR SAVING  
TRANSPORT CHARGES

**ATTENTION!**  
EMBALLAGE EN KIT POUR SAUVER  
FRAIS D'EXPEDITION

**ACHTUNG!**  
VERPACKUNG IN KIT UM  
VERSANDKOSTEN ZU SPAREN

## Carrelli portapiatti, vassoi e teglie - Dish, tray and pan carts - Chariot porte-assiettes, plateaux et plaques - Geschirrwagen, Tablett und Auflaufformen Tellerwagen.

 **CARRELLO PORTAPIATTI ARMADIATO.** Struttura portante in acciaio plastificato. Telaio in alluminio anodizzato. Pannellatura in PERFEX con n. 4 sportelli apribili in plexiglass. Griglie portapiatti in acciaio plastificato rilsan o cromate. Maniglie laterali per conduzione carrello. Ruote Ø 125 di cui due con freno.



Portata 96 piatti. Griglie verniciate per piatti 18/23  
Capacity 96 plates. Polished racks  
Capacité 96 plats. Grilles vernies  
Tragfähigkeit 96 Teller. Lackierte Gitter

**CA 1439 A**

**€ 1.350,00**

Portata 96 piatti. Griglie cromate per piatti 18/23  
Capacity 96 plates. Chromium-plated racks  
Capacité 96 plats. Grilles chromées  
Tragfähigkeit 96 Teller. Verchromte Roste

**CA 1440 A**

**€ 1.370,00**

Portata 92 piatti. Griglie verniciate per piatti 25/31  
Capacity 92 plates. Polished racks for dishes 25/31  
Capacité 92 plats. Grilles vernies pour assiettes 25/31  
Tragfähigkeit 92 Teller. Lackierte Gitter für Teller 25/31

**CA 1439 AG**

**€ 1.380,00**

Portata 92 piatti. Griglie cromate per piatti 25/31  
Capacity 92 plates. Chromium-plated racks for dishes 25/31  
Capacité 92 plats. Grilles chromées pour assiettes 25/31  
Tragfähigkeit 92 Teller. Verchromte Roste für Teller 25/31

**CA 1440 AG**

**€ 1.420,00**

DIMENSIONI ESTERNE - EXTERNAL DIMENSIONS LxPxH cm  
DIMENSIONS EXTERIEURES - AUBENABMESSUNGEN LxPxH cm

**75x78x183 h**

 **DISH CARTS WITH CABINET.** Supporting structure in plastic-coated steel. Frame in anodized aluminium. PERFEX panelling with 4 opening doors in plexiglass. Plate racks in rilsan plastic-coated or chromed steel. Side handles to steer trolley. Wheels diam. 125, two with brake.

 **CHARIOTS PORTE-ASSIETTES AVEC ARMOIRE.** Structure portante en acier plastifié. Châssis en aluminium anodisé. Panneaux en PERFEX avec 4 portes ouvrables en plexiglass. Grilles porte-assiettes en acier plastifié Rilsan au chromées. Poignées latérales de conduite du chariot. Roulettes Ø 125 dont deux à frein.

 **SCHRANKWAGEN FÜR GESCHIRR.** Tragende Struktur aus plastifiziertem Stahl. Gestell aus eloxiertem Aluminium. Verschalung aus PERFEX mit 4 Türen aus Plexiglass. Tellerroste aus Rilsanplastifiziertem oder verchromten Stahl. Seitliche Griffe zum Fahren des Wagens. Räder Ø 125, zwei davon mit Bremse.



Porta piatti con 10 Griglie verniciate GN 2/1  
Plate holder with 10 painted grids GN 2/1  
Porte assiettes avec 10 grilles peintes GN 2/1  
Tellerträger mit 10 lackierten Gittern GN 2/1

**CG 1439 A**

**€ 1.570,00**

DIMENSIONI ESTERNE - EXTERNAL DIMENSIONS LxPxH cm  
DIMENSIONS EXTERIEURES - AUBENABMESSUNGEN LxPxH cm

**75x78x170 h**

**Carrelli portapiatti, vassoi e teglie - Dish, tray and pan carts - Chariot porte-assiettes, plateaux et plaques - Geschirrwagen, Tablett und Auflaufformen Tellerwagen.**

 **CARRELLO PORTAPIATTI ANTIPASTI RISCALDATO A RESISTENZA W1600 230V. TERMOSTATO REGOLABILE 30/60°C.** Struttura portante in acciaio plastificato. Telaio in alluminio anodizzato. Pannellatura in PERFEX con n. 4 sportelli apribili in plexiglass. Griglie portapiatti in acciaio cromato. Maniglie laterali per conduzione carrello. Ruote Ø 125 di cui due con freno.

 **HEATED TROLLEY FOR HORS D'OEUVRE DISHES WITH HEATING ELEMENT W1600 V 230. ADJUSTABLE THERMOSTAT 30/60°C.** Supporting structure in plastic-coated steel. Frame in anodized aluminium. PERFEX panelling with 4 opening doors in plexiglass. Plate racks in chromed steel. Side handles to steer trolley. Wheels diam. 125, two with brake.



W 800 + W 800 Portata 88 piatti. Griglie cromate per piatti 18/23  
Capacity 88 plates. Polished racks  
Capacité 88 plats. Grilles vernies  
Tragfähigkeit 88 Teller. Lackierte Gitter

**CA 1440 AC**

**€ 2.000,00**

W 800 + W 800 Portata 84 piatti. Griglie cromate per piatti 25/31  
Capacity 84 plates. Chromium plated racks for dishes 25/31  
Capacité 84 plats. Grilles chromées pour assiettes 25/31  
Tragfähigkeit 84 Teller. Verchromte Roste für Teller 25/31

**CA 1440 ACG**

**€ 2.060,00**

DIMENSIONI ESTERNE - EXTERNAL DIMENSIONS LxPxH cm  
DIMENSIONS EXTERIEURES - AUßENABMESSUNGEN LxPxH cm

**75x78x177 h**

 **CHARIOT PORTE-ASSIETTES POUR HORS D'OEUVRE CHAUFFÉ AVEC RÉSISTANCE W1600 V 230. THÉRMOSTAT RÉGLABLE 30/60°C.** Structure portante en acier plastifié. Châssis en aluminium anodisé. Panneaux en PERFEX avec 4 portes ouvrantes en plexiglass. Grilles porte-assiettes en acier chromées. Poignées latérales de conduite du chariot. Roulettes Ø 125 dont deux à frein.

 **ERWAERMTER TELLERHALTERWAGEN FÜR VORSPEISETELLER MIT THERMOELEMENT W1600 V 230. REGULIERBARES THERMOSTAT 30/60°C.** Tragende Struktur aus plastifiziertem Stahl. Gestell aus eloxiertem Aluminium. Verschalung aus PERFEX mit 4 Türen aus Plexiglass. Tellerroste aus verchromtem Stahl. Seitliche Griffe zum Fahren des Wagens. Räder Ø 125, zwei davon mit Bremse.



Porta piatti riscaldato con 10 Griglie verniciate GN 2/1  
Warmed plate holder with 10 painted grids GN 2/1  
Porte assiettes chauffé avec 10 grilles peintes GN 2/1  
Erwärmter Tellerträger mit 10 lackierten Gittern GN 2/1

**CG 1439 AC**

**€ 2.250,00**

DIMENSIONI ESTERNE - EXTERNAL DIMENSIONS LxPxH cm  
DIMENSIONS EXTERIEURES - AUßENABMESSUNGEN LxPxH cm

**75x78x177 h**

**Carrelli portapiatti, vassoi e teglie - Dish, tray and pan carts - Chariot porte-assiettes, plateaux et plaques - Geschirrwagen, Tablett und Auflaufformen Tellerwagen.**

 **CARRELLO PORTAPIATTI ANTIPASTI REFRIGERATO A VENTILAZIONE +8° +12°C MANTENIMENTO TEMPORANEO PER PIATTI DIAM. 18-31.** Struttura portante in acciaio plastificato. Telaio in alluminio anodizzato. Pannellatura in isomac sp. 25 mm con n. 4 sportelli apribili in PLX. Griglie portapiatti in acciaio plastificato rilsan. Maniglie laterali per conduzione carrello. Ruote Ø 125 di cui due con freno.

 **VENTILATED REFRIGERATION TROLLEY +8° +12°C FOR HORS D'OEUVRES DISHE DIAM. 18-31 TEMPORARY KEEPING OF TEMPERATURE.** Supporting structure in plastic-coated steel. Frame in anodized aluminium. Isomac 25 mm thick panelling with 4 opening doors in plexiglass. Plate racks in rilsan plastic-coated steel. Side handles to steer trolley. Wheels diam. 125, two with brake.

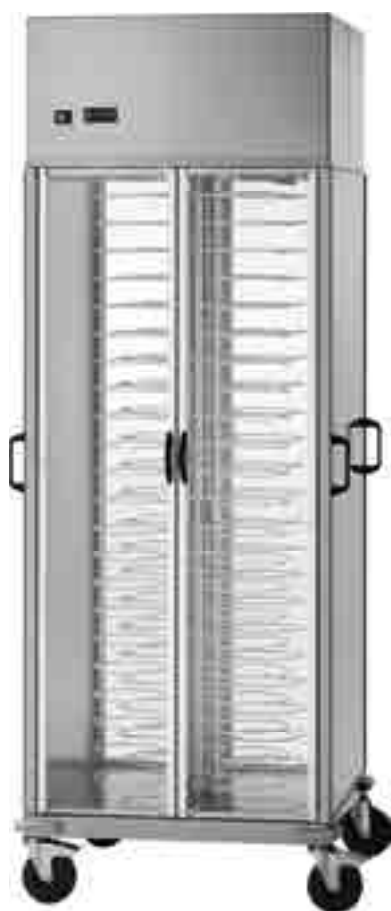

Portata 88 piatti. Griglie verniciate per piatti 18/23  
Capacity 88 plates. Polished racks  
Capacité 88 plats. Grilles vernies  
Tragfähigkeit 88 Teller. Lackierte Gitter

**CA 1439 R**

**€ 2.350,00**

Portata 88 piatti. Griglie verniciate per piatti 25/31  
Capacity 88 plates. Polished racks for dishes 25/31  
Capacité 88 plats. Grilles vernies pour assiettes 25/31  
Tragfähigkeit 88 Teller. Lackierte Gitter für Teller 25/31

**CA 1439 RG**

**€ 2.400,00**

DIMENSIONI ESTERNE - EXTERNAL DIMENSIONS LxPxH cm  
DIMENSIONS EXTERIEURES - AUßENABMESSUNGEN LxPxH cm

**75x78x203 h**

 **CHARIOT PORTE-ASSIETTES POUR HORS D'OEUVRE REFRIGÉRÉ À VENTILATION +8° +12°C MAINTIEN TEMPORAIRE POUR ASSIETTES DIAM. 18-31.** Structure portante en acier plastifié. Châssis en aluminium anodisé. Panneaux en isomac épais 25 mm avec 4 portes ouvrantes en plexiglass. Grilles porte-assiettes en acier plastifié rilsan. Poignées latérales de conduite du chariot. Roulettes Ø 125 dont deux à frein.

 **GEKÜHLTER TELLERWAGEN FÜR VORSPEISETELLER MIT LÜFTUNG +8° +12°C ZEITWEILIGE ERHALTUNG FÜR TELLER DURCH. 18-31.** Tragende Struktur aus plastifiziertem Stahl. Gestell aus eloxiertem Aluminium. Verschalung aus isomac 25 mm Dick mit 4 Türen aus Plexiglas. Tellerroste aus Rilsanplastifiziertem. Seitliche Griffe zum Fahren des Wagens. Räder Ø 125, zwei davon mit Bremse.

|   |                |
|---|----------------|
| Alimentazione - Power supply - Branchement - Anschluss                                | 230V~ 50Hz     |
| Potenza elettrica - Electrical power - Puissance électrique - Leistung                | 460W           |
| Potenza frigorifera - Refrigerating power - Puissance réfrigérante - Kalteleistung    | 510W 440Kcal/h |
| Refrigerante ecologico - Environment-friendly refrigerant - Réfrigérant - Kaltemittel | R 134 a        |



Porta piatti refrigerato con 10 Griglie verniciate GN 2/1  
Refrigerated plate holder with 10 painted grids GN 2/1  
Porte assiettes réfrigéré avec 10 grilles peintes GN 2/1  
Gekühlter Tellerträger mit 10 lackierten Gittern GN 2/1

**CG 1439 R**

**€ 2.650,00**

DIMENSIONI ESTERNE - EXTERNAL DIMENSIONS LxPxH cm  
DIMENSIONS EXTERIEURES - AUßENABMESSUNGEN LxPxH cm

**75x78x203 h**

**Carrelli portapiatti, vassoi e teglie - Dish, tray and pan carts - Chariot porte-assiettes, plateaux et plaques - Geschirrwagen, Tablett und Auflaufformen Tellerwagen.**

 **CARRELLO PORTAPIATTI.** Struttura in tubo di acciaio inox. Ripiano portapiatti e pannellatura in lamiera di acciaio inox. Ruote piroettanti. Portata 200 piatti circa.

 **DISH TROLLEY.** Stainless steel tube frame. Bottom shelf and panneling in stainless steel. Swivelling wheels. Capacity 200 plates approx.

 **CHARIOTS PORTE-ASSIETTES.** Châssis porteur en tube d'acier inox. Porte-assiettes et panneaux en acier inox. Roues pivotantes. Portée d'environ 200 assiettes.

 **GESCHIRRWAGEN.** Gestell aus rostfreiem Stahlrohr. Tellerhalterplatte und Täfelung aus rostfreiem Stahlaminat. Pirouettierende Rollen. Tragfähigkeit ca. 200 Teller.



**CP 1441**

**€ 370,00**

DIMENSIONI ESTERNE - EXTERNAL DIMENSIONS LxPxH cm  
DIMENSIONS EXTERIEURES - AUßENABMESSUNGEN LxPxH cm

**91x57x101 h**



Con piano superiore inox / With stainless steel upper shelf  
Avec étage supérieur en acier inox / Mit oberer Etage aus rostfreiem Stahl

**CP 1441 C**

**€ 420,00**

DIMENSIONI ESTERNE - EXTERNAL DIMENSIONS LxPxH cm  
DIMENSIONS EXTERIEURES - AUßENABMESSUNGEN LxPxH cm

**91x57x101 h**



**Optionals**

**A 512** Ruote con freno - Wheels with catch - Roues avec frein - Räder mit Bremse **€ 7,00 cad./each**

**A 1001** Cestino piccolo - Small basket - Petit panier - Klein Korb (per/for CP 1441 - 1441C) **€ 10,00**

**A 1002** Cestino grande - Big basket - Grand panier - Gros Korb (per/for CP 1441 - 1441C) **€ 22,00**

## Carrelli portapiatti, vassoi e teglie - Dish, tray and pan carts - Chariot porte-assiettes, plateaux et plaques - Geschirrwagen, Tablett und Auflaufformen Tellerwagen.

 Carrelli per ritiro, distribuzione e stoccaggio vassoi, piatti, tazze, ecc. Telaio in acciaio inox. Cesti asportabili in filo di acciaio plastificato. Ruote pivotanti Ø mm 120. Paracolpi.

 Trays, dishes, cups stacking and distribution trolleys. Stainless steel framework. Detachable basket in plastic coated steel wire. Full swivelling castors Ø mm 120. Bumpers.

 Chariots pour distribution et rangement de plateaux, assiettes et tasses. Châssis en acier inox. Panier amovible en fil d'acier plastifié. Roulettes pivotantes Ø mm 120. Parechocs.

 Wagen für Abdecken, Verteilung und Lagerung der Servierbretter, Teller ecc. Struktur aus Edelstahl. Korb aus plastifiziertem Stahl. Lankräder Ø 120 mm. Stossfänger.



Un cesto, portata 100 piatti  
One basket. Capacity 100 dishes  
Un panier. Capacité 100 assiettes  
Ein Korb. Tragfähigkeit 100 Teller

**CA 656**

**€ 320,00**

DIMENSIONI ESTERNE - EXTERNAL DIMENSIONS LxPxH cm  
DIMENSIONS EXTERIEURES - AUßENABMESSUNGEN LxPxH cm

**88x50x92 h**



Portata 130 vassoi  
Capacity approx 130 trays  
Capacité 130 plateaux environ  
Tragfähigkeit 130 Tabletten

**CA 631**

**€ 270,00**

DIMENSIONI ESTERNE - EXTERNAL DIMENSIONS LxPxH cm  
DIMENSIONS EXTERIEURES - AUßENABMESSUNGEN LxPxH cm

**75x65x92 h**



Due cesti, portata 200 piatti  
Two baskets. Capacity 200 dishes  
Due paniers. Capacité 200 assiettes  
Zwei Körbe. Tragfähigkeit 200 Teller

**CA 659**

**€ 500,00**

DIMENSIONI ESTERNE - EXTERNAL DIMENSIONS LxPxH cm  
DIMENSIONS EXTERIEURES - AUßENABMESSUNGEN LxPxH cm

**88x105x98 h**

### Optionals



**A 512**

Ruote con freno - Wheels with catch - Roues avec frein - Räder mit Bremse

**€ 7,00 cad./each**

## Carrello scolapiatti-bicchieri - Dish and glass drying rack trolley

### Chariot égouttoir à vaisselle - verres - Abtropfwagen für Geschirr und Gläser

-  Struttura in acciaio sabbiato EPOSS. Elementi portapiatti in plastica fusa. Vasca raccogli condensa in polistirolo antiurto. Cestelli portabicchieri, posate, ecc. in filo di acciaio plastificato. Ruote pivotanti Ø mm 120. Paracolpi.
-  Enamel coated steel framework. Moulded plastic dish-racks. Dipping pan in stockresistant polystyrene. Glass and cutlery baskets, in plastic coated steel wire. Full swivelling castors Ø mms 120. Bumpers.
-  Châssis en acier sablé. Porte-assiettes en plastique. Cuve ramasse-gouttles en polystireneparechocs. Paniers pour les verres et les couverts en fil d'acier plastifié. Roulettes pivotantes Ø 120 mm. Parechocs.
-  Struktur aus EPOSS - Stahl. Tellerhalter aus Kunststoff. Tropfenauffangschale aus stossfester Polystiren. Körbe für Gläser und besteck aus plastifiziertem Stahldraht. Lankräder Ø 120 mm. Stossfänger.
-  Struttura in acciaio sabbiato EPOSS. Vasca raccogli condensa in lamiera INOX. Quattro elementi asportabili portapiatti e due portabicchieri. Portata 100 piatti. Ruote pivotanti Ø mm 100. Cestelli supplementaria richiesta.
-  Enamel coated steel frameworks. Dripping pan in stainless steel sheet. Four detachable dish-racks and two glass racks. Capacity 100 dishes. Full swivelling castors Ø mms 100. Extra racks available on request.
-  Châssis en acier sablé. Cuve ramasse-gouttles en feuille d'acier inox. Quatre porteassiettes amovibles et deux paniers pour les verres. capacité 100 assiettes. Roulettes pivotantes Ø mm 100. Paniers supplémentaires disponible sur demande.
-  Struktur aus EPOSS-Stahl. Tropfenauffangeschale aus Edelstahl Blättern. Vier aufziehbare Tellerhalter, zwei Körbe für Gläser. Tragfähigkeit 100. Drehräder ø 100 mm. Zusätzliche Körbe auf Anfrage.



Portata 300 piatti - Capacity 300 dishes.  
Capacité 300 assiettes - Tragfähigkeit 300 Teller.

**CA 602**

**€ 1.050,00**

Portata 200 piatti. Due cestelli portabicchieri.  
Capacity 200 dishes. Two glass racks.  
Capacité 200 assiettes. Deux paniers pour les verres.  
Tragfähigkeit 200 Teller. Zwei Körbe für Gläser.

**CA 603**

**€ 1.080,00**

Sei cestelli portabicchieri - Six glass racks  
Six paniers pour les verres - Sechs Körbe für Gläser

**CA 604**

**€ 1.180,00**

DIMENSIONI ESTERNE - EXTERNAL DIMENSIONS LxPxH cm  
DIMENSIONS EXTERIEURES - AUßENABMESSUNGEN LxPxH cm

**117x62x110 h**



**CA 609**

**€ 600,00**

DIMENSIONI ESTERNE - EXTERNAL DIMENSIONS LxPxH cm  
DIMENSIONS EXTERIEURES - AUßENABMESSUNGEN LxPxH cm

**80x60x105 h**



## Scolapiatti e bicchieri da muro - Dish and glass drying racks on wall Egouttier pour assiettes et verres à mur - Abtropfwagen für Geschirr und Gläser für Wand

 Telaio in tubo di acciaio inox. Ripiani con griglie in acciaio inox per piatti. Vaschette scola bicchieri in acciaio inox. Piano raccogli gocce in acciaio inox. Ruote piroettanti.

 Frame in tubular stainless steel. Stainless steel racks for plates. Stainless steel glass draining tray. Stainless steel drip tray. Swivelling wheels.

 Châssis tubulaire en acier inox. Etagères à grilles en acier inox pour assiettes. Bac égouttoir à verres en acier inox. Cuvette d'égouttage en acier inox. Roulettes pivotantes.

 Gestell aus Niro-Stahl-Rohr. Roste aus Niro-Stahl für Teller. Gläser-Abtropfwanne aus Niro-Stahl. Tropfenauffang-Fläche aus Niro-Stahl. Drehräder.



3 piani scolapiatti.  
3 shelves dish draining trolley.  
Chariot-égouttoir pour assiettes. 3 etages.  
Abtropfwagen für Teller. 3 Etagen.

**CA 1399**

**€ 495,00**

DIMENSIONI ESTERNE - EXTERNAL DIMENSIONS LxPxH cm  
DIMENSIONS EXTERIEURES - AUßENABMESSUNGEN LxPxH cm

**110x62x134 h**

1 piano scolabicchieri 2 piani scolapiatti.  
2 shelves dish and 1 shelve glass draining trolley.  
Chariot-égouttoir: 1 rayon pour verres et 2 rayons pour assiettes.  
Abtropfwagen: 1 Etage für Gläser und 2 Etagen für Teller.

**CA 1400**

**€ 560,00**

DIMENSIONI ESTERNE - EXTERNAL DIMENSIONS LxPxH cm  
DIMENSIONS EXTERIEURES - AUßENABMESSUNGEN LxPxH cm

**110x62x134 h**

4 piani scolapiatti  
4 shelves dish draining trolley  
Chariot-égouttoir pour assiettes. 4 etages  
Abtropfwagen für Teller. 4 Etagen

**CA 1401**

**€ 600,00**

DIMENSIONI ESTERNE - EXTERNAL DIMENSIONS LxPxH cm  
DIMENSIONS EXTERIEURES - AUßENABMESSUNGEN LxPxH cm

**110x62x160 h**

 Realizzati in acciaio inox lucido 18/8.

 In 18/8 bright stainless steel.

 Aus rostfreiem Glanzstahl 18/8.

 Réalisé en acier inoxydable 18/8.



**SPB 1398**

**€ 70,00**

DIMENSIONI ESTERNE - EXTERNAL DIMENSIONS LxPxH cm  
DIMENSIONS EXTERIEURES - AUßENABMESSUNGEN LxPxH cm

**80x26x37 h**

 Realizzati in acciaio inox lucido 18/8.

 In 18/8 bright stainless steel.

 Aus rostfreiem Glanzstahl 18/8.

 Réalisé en acier inoxydable 18/8.



**SP 1397**

**€ 135,00**

DIMENSIONI ESTERNE - EXTERNAL DIMENSIONS LxPxH cm  
DIMENSIONS EXTERIEURES - AUßENABMESSUNGEN LxPxH cm

**104x30x55 h**

**Cestelli per lavastoviglie 50x50 - Racks for dishwashing machines**  
**Paniers pour lave-vaisselle - Körbe für Spülmaschine**



|                |  |                |
|----------------|--|----------------|
| <b>BVM</b>     | base vuota h 90 mm col. grigio per posate                      | <b>€ 18,00</b> |
| <b>BV</b>      | base vuota h 90 mm col. grigio universale                      | <b>€ 18,00</b> |
| <b>B9</b>      | base 9 scomparti h 90 mm col. grigio (bicchiere diam. 140 mm)  | <b>€ 20,00</b> |
| <b>B16</b>     | base 16 scomparti h 90 mm col. grigio (bicchiere diam. 110 mm) | <b>€ 21,50</b> |
| <b>B25</b>     | base 25 scomparti h 90 mm col. grigio (bicchiere diam. 80 mm)  | <b>€ 23,00</b> |
| <b>B36</b>     | base 36 scomparti h 90 mm col. grigio (bicchiere diam. 70 mm)  | <b>€ 24,00</b> |
| <b>B49</b>     | base 49 scomparti h 90 mm col. grigio (bicchiere diam. 60 mm)  | <b>€ 26,00</b> |
| <b>BP</b>      | base per piatti o vassoi h 90 mm col. grigio                   | <b>€ 19,00</b> |
| <b>BA</b>      | base per vassoi aperto su un lato h 90 mm col. grigio          | <b>€ 20,00</b> |
| <b>RIAU</b>    | rialzo universale h 45 mm col. blu                             | <b>€ 9,00</b>  |
| <b>RIA9</b>    | rialzo 9 scomparti h 45 mm col. blu                            | <b>€ 10,00</b> |
| <b>RIA25</b>   | rialzo 25 scomparti h 45 mm col. blu                           | <b>€ 10,00</b> |
| <b>RIA36</b>   | rialzo 36 scomparti h 45 mm col. blu                           | <b>€ 10,00</b> |
| <b>RIA49</b>   | rialzo 49 scomparti h 45 mm col. blu                           | <b>€ 11,00</b> |
| <b>RIA16</b>   | rialzo 16 scomparti h 45 mm col. blu                           | <b>€ 10,00</b> |
| <b>CP8</b>     | cestellino inserto portaposate 8 scomparti                     | <b>€ 12,00</b> |
| <b>COPCEST</b> | copertchio standard per cestelli                               | <b>€ 14,00</b> |



Carrello portacestelli inox  
 Stainless steel dishwasher trays trolley  
 Chariot porte-paniers en acier inox  
 Edelstahl Wagen für Spülmaschinekörbchen.

**CP 1442**





**€ 280,00**

DIMENSIONI ESTERNE - EXTERNAL DIMENSIONS LxPxH cm  
 DIMENSIONS EXTERIEURES - AUßENABMESSUNGEN LxPxH cm

**65x65x170 h**

## Portacestelli per lavastoviglie - Dish washer tray trolley Porte-paniers pour lave-vaisselle - Korbhalter für Spülmaschinen



-  Vasca in ABS. Manico inox.
-  Container in ABS stainless steel handle.
-  Cuve en ABS poignée en acier inox.
-  Behälter aus ABS Handgriff aus Edelstahl.

Con manico - With handle - Avec poignée - Mit handgriff

**CP 1447** € 120,00





DIMENSIONI ESTERNE - EXTERNAL DIMENSIONS LxPxH cm **53x56x92 h**  
DIMENSIONS EXTERIEURES - AUßENABMESSUNGEN LxPxH cm

Senza manico - Without handle - Sans poignée - Ohne Handgriff

**CP 1448** € 85,00

DIMENSIONI ESTERNE - EXTERNAL DIMENSIONS LxPxH cm **53x56x21 h**  
DIMENSIONS EXTERIEURES - AUßENABMESSUNGEN LxPxH cm



-  Interamente in acciaio inox.
-  Entirely stainless steel.
-  Entièrement en acier inoxydable.
-  Komplett aus rostfreiem Stahl.

Con manico - With handle - Avec poignée - Mit handgriff

**CP 1445** € 200,00





DIMENSIONI ESTERNE - EXTERNAL DIMENSIONS LxPxH cm **52x58x96 h**  
DIMENSIONS EXTERIEURES - AUßENABMESSUNGEN LxPxH cm

Senza manico - Without handle - Sans poignée - Ohne Handgriff

**CP 1446** € 180,00

DIMENSIONI ESTERNE - EXTERNAL DIMENSIONS LxPxH cm **52x52x20 h**  
DIMENSIONS EXTERIEURES - AUßENABMESSUNGEN LxPxH cm



-  Interamente in acciaio inox. Per cassetta impasti pizza 60x40.
-  Entirely stainless steel. For pizza dough container size 60x40.
-  Entièrement en acier inoxydable. Pour récipient pour pâte à pizza dimensions 60x40.
-  Komplett aus rostfreiem Stahl. Für Behälter für Pizzateig Abmessungen 60x40.

Con manico - With handle - Avec poignée - Mit handgriff

**CB 1444** € 210,00

DIMENSIONI ESTERNE - EXTERNAL DIMENSIONS LxPxH cm **72x42x96 h**  
DIMENSIONS EXTERIEURES - AUßENABMESSUNGEN LxPxH cm

Senza manico - Without handle - Sans poignée - Ohne Handgriff

**CB 1443** € 185,00

DIMENSIONI ESTERNE - EXTERNAL DIMENSIONS LxPxH cm **62x42x20 h**  
DIMENSIONS EXTERIEURES - AUßENABMESSUNGEN LxPxH cm



***Carrelli portabiancheria, pulizia, multiuso*** 

***Carrello strizzatore***

***Cestone portabiancheria***

***Cesto pieghevole plastificato***

***Carrello multiuso cromato***

***Carrello in plastica***

***Laundry, cleaning, multipurpose trolley*** 

***Mop Squeezing trolley***

***Folding laundry trolley***

***Plastic folding basket***

***Multiuse trolley***

***Plastic trolley***

***Chariots porte-linge, Nettoyage, Multi-usage*** 

***Chariot-essoreuse***

***Chariot pliable porte-linge***

***Panier pliant plastifié***

***Chariot multiservice***

***Chariot en plastique***

***Wagen für Wäschereien, Reinigungsbetriebe, Mehrzweck*** 

***Kübel-Wagen***



***Klappbarer Wagen***



***Plastifizierter Klappkorb***

***Verchromter Mehrzwechwagen***

***Wagen aus Kunststoff***

**Carrelli portabiancheria, pulizia, multiuso - Laundry, cleaning, multipurpose trolley**  
**Chariots porte-linge, Nettoyage, Multi-usage - Wagen für Wäschereien, Reinigungsbetriebe, Mehrzweck**

-  Struttura in acciaio inox. Un sacco in tessuto ignifugo. Piani in laminato. Ruote multidirezionali. Paracolpi in gomma.
-  Stainless steel structure. One sack made of fireproof clothes. Laminated shelves. Multidirectional wheels. Rubber buffer.

-  Structure en acier inoxydable. Un sac en toile ignifuge. Rayons laminés. Roues pivotantes. Butoir en gomme.
-  Gestell aus rostfreiem Stahl mit ein Wäschesack aus feuerfestem Gewebe. Laminat-platten. Leichtlaufende Rollen. Gummipuffer.



Acciaio inox - Stainless steel - Acier inoxydable - Rostfreier Stahl

**CA 1501**

**€ 260,00**

DIMENSIONI ESTERNE - EXTERNAL DIMENSIONS LxPxH cm  
 DIMENSIONS EXTERIEURES - AUßENABMESSUNGEN LxPxH cm

**79x43x129 h**

In dotazione N° 1 sacco in tessuto ignifugo  
 No. 1 fireproof sack included  
 N. 1 sac en tissu ignifuge compris  
 Nr. 1 Feuerfestem Sack inbegriffen



Braccio pieghevole - Folding sack-holder  
 Porte-sac pliable - Sackträger Klappbar

**CA 1505**

**€ 460,00**

Come sopra in wengè - As above in wengé  
 Comme ci-dessus en wengé - Wie oben aus Wengé

**CA 1505W**

**€ 460,00**

DIMENSIONI ESTERNE LxPxH cm    CHIUSO/APERTO  
 EXTERNAL DIMENSIONS LxPxH cm    CLOSED / OPEN  
 DIMENSIONS EXTERIEURES LxPxH cm    FERMÉ / OUVERT  
 AUßENABMESSUNGEN LxPxH cm    GESCHLOSSEN / GEÖFFNET

**70/100x50x123 h**

**Optionals**

**A 515**    Ruote con freno - Wheels with catch - Roues avec frein - Räder mit Bremse

**€ 9,00 cad./each**

**Carrelli portabiancheria, pulizia, multiuso - Laundry, cleaning, multipurpose trolley**  
**Chariots porte-linge, Nettoyage, Multi-usage - Wagen für Wäschereien, Reinigungsbetriebe, Mehrzweck**



Braccio pieghevole - Folding sack-holder  
 Porte-sac pliable - Sackträger Klappbar

**CA 1510**

**€ 490,00**

Come sopra in wengè - As above in wengè  
 Comme ci-dessus en wengé - Wie oben aus Wengé

**CA 1510W**

**€ 490,00**

|                                 |                        |                        |
|---------------------------------|------------------------|------------------------|
| DIMENSIONI ESTERNE LxPxH cm     | CHIUSO/APERTO          | <b>90/143x50x123 h</b> |
| EXTERNAL DIMENSIONS LxPxH cm    | CLOSED /OPEN           |                        |
| DIMENSIONS EXTERIEURES LxPxH cm | FERMÉ / OUVERT         |                        |
| AUßENABMESSUNGEN LxPxH cm       | GESCHLOSSEN / GEÖFFNET |                        |

In dotazione N° 1 sacco in tessuto ignifugo  
 No. 1 fireproof sack included  
 N. 1 sac en tissu ignifuge compris  
 Nr. 1 Feuerfestem Sack inbegriffen



Braccio pieghevole - Folding sack-holder  
 Porte-sac pliable - Sackträger Klappbar

**CA 1515**

**€ 500,00**

Come sopra in wengè - As above in wengè  
 Comme ci-dessus en wengé - Wie oben aus Wengé

**CA 1515W**

**€ 500,00**

|                                 |                        |                         |
|---------------------------------|------------------------|-------------------------|
| DIMENSIONI ESTERNE LxPxH cm     | CHIUSO/APERTO          | <b>110/143x50x123 h</b> |
| EXTERNAL DIMENSIONS LxPxH cm    | CLOSED /OPEN           |                         |
| DIMENSIONS EXTERIEURES LxPxH cm | FERMÉ / OUVERT         |                         |
| AUßENABMESSUNGEN LxPxH cm       | GESCHLOSSEN / GEÖFFNET |                         |

**Optionals**

**A 515**

Ruote con freno - Wheels with catch - Roues avec frein - Räder mit Bremse

**€ 9,00 cad./each**

## Carrelli portabiancheria, pulizia, multiuso - Laundry, cleaning, multipurpose trolley

## Chariots porte-linge, Nettoyage, Multi-usage - Wagen für Wäschereien, Reinigungsbetriebe, Mehrzweck

 Quattro piani. Cassetta superiore portaccessori. Un sacco in tessuto ignifugo. Ruote Ø mm 120. Paracolpi. Portascopa.

 Four shelves. Top tray for toilet articles and cleaning materials. One sack made of fireproof clothes. Castors Ø mms 120. Bumpers. Broom holder.



 Quatre étagères. Bac supérieur pour accessoires de nettoyage. Un sac en toile ignifuge. Roulettes Ø 120 mm. Butoir. Porte balais.

 Vier Abstellflächen. Zubehörabstellfach. Ein Wäschesack aus feuerfestem Gewebe. Lenkräder Ø 120 mm. Stossfänger. Besenhalter.

Bracci pieghevoli, acciaio inox, piani in laminato  
Folding sackholders, stainless steel, laminate shelves  
Porte-sacs pliables, acier inox, étagères en stratifié  
Sackträger Klappbar, Rostfreiem Stahl, Laminatplatten

**CA 740**

**€ 700,00**

|                                 |                        |
|---------------------------------|------------------------|
| DIMENSIONI ESTERNE LxPxH cm     | CHIUSO/APERTO          |
| EXTERNAL DIMENSIONS LxPxH cm    | CLOSED / OPEN          |
| DIMENSIONS EXTERIEURES LxPxH cm | FERMÉ / OUVERT         |
| AUBENABMESSUNGEN LxPxH cm       | GESCHLOSSEN / GEÖFFNET |

**82/152x50x158 h**

In dotazione N° 1 sacco in tessuto ignifugo  
No. 1 fireproof sack included  
N. 1 sac en tissu ignifuge compris  
Nr. 1 Feuerfestem Sack inbegriffen



Bracci pieghevoli. Interamente in acciaio inox  
Folding sack-holders. Entirely stainless steel  
Porte-sacs pliables. Entièrement en acier inox  
Sackträger Klappbar. Komplet aus Rostfreiem Stahl

**CA 1525**

**€ 780,00**

|                                 |                        |
|---------------------------------|------------------------|
| DIMENSIONI ESTERNE LxPxH cm     | CHIUSO/APERTO          |
| EXTERNAL DIMENSIONS LxPxH cm    | CLOSED / OPEN          |
| DIMENSIONS EXTERIEURES LxPxH cm | FERMÉ / OUVERT         |
| AUBENABMESSUNGEN LxPxH cm       | GESCHLOSSEN / GEÖFFNET |

**82/152x50x158 h**

### Optionals

**A 515** Ruote con freno - Wheels with catch - Roues avec frein - Räder mit Bremse

**€ 9,00 cad./each**



**Carrelli portabiancheria, pulizia, multiuso - Laundry, cleaning, multipurpose trolley**  
**Chariots porte-linge, Nettoyage, Multi-usage - Wagen für Wäschereien, Reinigungsbetriebe, Mehrzweck**



- 🇮🇹 Struttura in lamiera verniciata a polveri epossidiche. 3 piani intermedi regolabili, con 2 porta sacchi, di cui N° 1 sacco ignifugo in dotazione, vaschetta porta detersivi superiore, Ruote piroettanti Ø 140 mm di cui 2 fisse e 2 girevoli.
- 🇬🇧 Structure in metal sheet painted with epoxy paint. 3 adjustable shelves, 2 sack holders, 1 fireproof sack included, upper container for cleaning products. 2 fixed and 2 multidirectional Ø 140 mm. wheels.
- 🇫🇷 Structure en tôle vernie avec peinture époxy. 3 étagères réglables, 2 porte-sacs, 1 sac ignifuge, récipient supérieur pour les détergents, roues de Ø 140 mm: 2 fixes et 2 pivotantes.
- 🇩🇪 Gestell aus Epoxidpulver lackiertem Blech. 3 regulierbare Zwischenplatten, 2 Sacketräger, 1 feuerfester Sack inbegriffen, oberer Behälter für Reinigungsmittel. Rollen Ø 140 mm.: 2 feste und 2 drehbare.

**CA 1530**

**€ 930,00**

|                                 |                        |
|---------------------------------|------------------------|
| DIMENSIONI ESTERNE LxPxH cm     | CHIUSO/APERTO          |
| EXTERNAL DIMENSIONS LxPxH cm    | CLOSED / OPEN          |
| DIMENSIONS EXTERIEURES LxPxH cm | FERMÉ / OUVERT         |
| AUßENABMESSUNGEN LxPxH cm       | GESCHLOSSEN / GEÖFFNET |

**80/153x50x128 h**

In dotazione N° 1 sacco in tessuto ignifugo  
 No. 1 fireproof sack included  
 N. 1 sac en tissu ignifuge compris  
 Nr. 1 Feuerfestem Sack inbegriffen

**Optionals**





**A 518**

Ruote con freno - Wheels with catch - Roues avec frein - Räder mit Bremse

**€ 20,00 cad./each**

## Carrello rifornimento frigo-bar - Mini bar supply trolley Chariot pour frigobar - Kühlbar-Bestückungswagen



-  Struttura in lamiera verniciata a polveri epossidiche. 3 piani intermedi regolabili. Vaschetta laterale per la raccolta dei vuoti, asportabile. Ruote piroettanti Ø 140 mm di cui 2 fisse e 2 girevoli.
-  Painted metal structure. 3 intermediate adjustable shelves. Lateral container for empties. Multidirectional Weels Ø 140 mm: 2 fixed and 2 turnable.
-  Structure tôle vernie. 3 rayons intermédiares réglables. Réceptient laterale pour la récolte des verres. Roues pivotantes Ø 140 mm: 2 fixés et 2 tournantes.
-  Gestell aus Bellech mit Epoxydpulverbeschichtung. 3 regulierbare Zwischenplatten. Seitlicher, abnehmbarer Leergut-Behälter. 2 feste und 2 drehbare pirouettierende Roller von Ø 140 mm.

**CR 1696**

**€ 750,00**

DIMENSIONI ESTERNE LxPxH cm  
EXTERNAL DIMENSIONS LxPxH cm  
DIMENSIONS EXTERIEURES LxPxH cm  
AUBENABMESSUNGEN LxPxH cm

**80x50x118 h**



**ATTENZIONE!** Foto con OPTIONAL / **WARNING!** Photo with EXTRA ACCESSORIES INCLUDED / **ATTENTION!** Photo avec ACCESSOIRES EXTRA / **ACHTUNG!** Foto mit EXTRAUSSTATTUNG

### Optionals

|               |   |                          |
|---------------|---|--------------------------|
| <b>A 1001</b> | Cestino piccolo - Small basket - Petit panier - Klein Korb (per/for CP1010) | <b>€ 10,00 cad./each</b> |
| <b>A 1002</b> | Cestino grande - Big basket - Grand panier - Gros Korb (per/for CP1010)     | <b>€ 22,00 cad./each</b> |
| <b>A 518</b>  | Ruote con freno - Wheels with catch - Roues avec frein - Räder mit Bremse   | <b>€ 20,00 cad./each</b> |

**Carrelli portabiancheria, pulizia, multiuso - Laundry, cleaning, multipurpose trolley**  
**Chariots porte-linge, Nettoyage, Multi-usage - Wagen für Wäschereien, Reinigungsbetriebe, Mehrzweck**

- 🇮🇹 Carrello strizzatore secchio con divisorio e strizzatore completo di struttura di rialzo per prodotti pulizia con ruote.
- 🇬🇧 Mop Squeezing trolley with divide and squeezer. Complete with wheeled raised structure for cleaning products.
- 🇫🇷 Chariot-essoreuse. Seau avec séparation etessoreuse. Equipé d'une structure serélevée à roulettes pour les produits d'entretien.
- 🇩🇪 Kübel-Wagen mit Unterteilung und Ausdrückvorrichtung. Komplet mit erhöhter Struktur für Putzmittel, mit Rädern.



**CA 1599**

**€ 130,00**

DIMENSIONI ESTERNE - EXTERNAL DIMENSIONS LxPxH cm  
 DIMENSIONS EXTERIEURES - AUßENABMESSUNGEN LxPxH cm

**55x27x87 h**

- 🇮🇹 Carrello strizzatore nylon lt 50 completo di 2 secchi lt 25, impugnatura reversibile, strizzatore plastica, ruote piroettanti Ø 80.
- 🇬🇧 Trolley with wringing nylon box lt 50. It comes with 2 buckets lt 25. reversible handle. Plastic wringing box. Multidirectional wheels Ø 80.
- 🇫🇷 Chariot avec tordre-torchon en nylon lt 50 2 seaux lt 25. Poignée reversible. Tordretorchon en plastique. Roues pivotentes Ø 80.
- 🇩🇪 Nylon-Auswringwagen zu 50 l mit 2 Eimern zu je 25 l, Wendegriff Kunststoffauswringler, pirouettierende Rollen Ø 80.



**CA 1604**

**€ 155,00**

DIMENSIONI ESTERNE - EXTERNAL DIMENSIONS LxPxH cm  
 DIMENSIONS EXTERIEURES - AUßENABMESSUNGEN LxPxH cm

**69x42x85 h**



**CA 1599E**

**€ 75,00**

DIMENSIONI ESTERNE - EXTERNAL DIMENSIONS LxPxH cm  
 DIMENSIONS EXTERIEURES - AUßENABMESSUNGEN LxPxH cm

**60x40x92 h**



**CA 1604E**

**€ 90,00**

DIMENSIONI ESTERNE - EXTERNAL DIMENSIONS LxPxH cm  
 DIMENSIONS EXTERIEURES - AUßENABMESSUNGEN LxPxH cm

**71x43x93 h**

## Carrelli portabiancheria, pulizia, multiuso - Laundry, cleaning, multipurpose trolley

### Chariots porte-linge, Nettoyage, Multi-usage - Wagen für Wäschereien, Reinigungsbetriebe, Mehrzweck

 Carrello in plastica. Telaio in plastica con ruote Ø 80 mm. Impugnatura ad "U" in plastica. 1 secchio in plastica lt. 28 con divisorio rosso. Strizzatore in plastica a libro senza fondo". DEEP" Manubrio completo di rinforzi, Portasacco lt. 120 in plastica completo di rinforzi e coperchio. Piatto reggisacco. Portasecchi in plastica completo di supporti. 2 secchi in plastica lt. 4. Gancio in plastica portapaletta. Gancio "FLIP" portamanico con rullo in gomma.

 Plastic trolley. Plastic frame with wheels Ø 80 mm. Plastic handle "U" shape. 1 plastic bucket lt. 28 with red divider. Plastic wringing tool with book system without bottom "DEEP". Reinforced handle. Plastic sack holder 120 lt. reinforced and with lid. Sack holder plate. Plastic bucket holder with supports. 2 plastic bucket lt. 4. Plastic hook for shovel. "FLIP" hook handle holder with rubber roller.

 Carrello in plastica. Telaio in plastica con ruote. Strizzatore in plastica con divisorio. Porta sacco con robusto sacco lt. 120 in plastica. attacchi porta utensili.

 Plastic trolley. Plastic frame with wheels. Plastic mop wringer with separator. Sac holder with lt. 120 strong plastic sac. Fittings for tools.



**CA 1613**

**€ 295,00**

DIMENSIONI ESTERNE - EXTERNAL DIMENSIONS LxPxH cm  
DIMENSIONS EXTERIEURES - AUßENABMESSUNGEN LxPxH cm

**107x56x111 h**



**CA 1606E**

**€ 190,00**

DIMENSIONI ESTERNE - EXTERNAL DIMENSIONS LxPxH cm  
DIMENSIONS EXTERIEURES - AUßENABMESSUNGEN LxPxH cm

**114x51x98 h**

## **Carrelli portabiancheria, pulizia, multiuso - Laundry, cleaning, multipurpose trolley** **Chariots porte-linge, Nettoyage, Multi-usage - Wagen für Wäschereien, Reinigungsbetriebe, Mehrzweck**

- Carrello multiuso completo di reggisacco, secchio plastica Lt.15. Strizzatore, Cassetta plastica media, 2 secchi Lt.4, cestino portabottiglie. Ruote Ø 100, ganci portascopo.
- Multipurpose trolley with sack holder, plastic bucket Lt.15. Wringer, medium size plastic container, 2 buckets capacity Lt.4, bottle rack. Wheels Ø 100, broom hooks.
- Chariot multiservice avec porte-sac, seau en plastique Lt.15. Tordre-torchon, récipient en plastique moyenne, 2 seaux capacité 4 Lt., porte-bouteilles. Roues Ø 100, crochets pour balais.
- Mehrzweckwagen mit Sackträger, Plastikeimer Lt.15. Wringer, mittlere Kunststoffbehälter ,2 Eimer Kapazität Lt.4. Flaschenhalter, Räder Ø 100, Haken für Besen.
- Carrello multiuso completo di reggisacco, 2 secchi plastica Lt.15. Strizzatore, Cassetta plastica media, 4 secchi Lt.4, cestino portabottiglie. Ruote Ø 100, ganci portascopo, vano centrale con cassetto scorrevole.
- Multipurpose trolley with sack holder, 2 plastic buckets Lt.15. Wringer, medium size plastic container, 4 buckets capacity Lt.4, bottle rack. Wheels Ø 100, broom hooks, central space with sliding drawer.
- Chariot multiservice avec porte-sac, 2 seaux en plastique Lt.15. Tordre-torchon, récipient en plastique moyenne ,4 seaux capacité 4 Lt., porte-bouteilles. Roues Ø 100, crochets pour balais, compartiment centrale avec tiroir coulissant.
- Mehrzweckwagen mit Sackträger, 2 Plastikeimer Lt.15. Wringer, mittlere Kunststoffbehälter ,4 Eimer Kapazität Lt.4. Flaschenhalter, Räder Ø 100, Haken für Besen, zentralen Raum mit Schublade.

**NEW**



**CA 1614**

**€ 340,00**

DIMENSIONI ESTERNE - EXTERNAL DIMENSIONS LxPxH cm  
 DIMENSIONS EXTERIEURES - AUßENABMESSUNGEN LxPxH cm

**92x55x124 h**



**CA 1615**

**€ 360,00**

DIMENSIONI ESTERNE - EXTERNAL DIMENSIONS LxPxH cm  
 DIMENSIONS EXTERIEURES - AUßENABMESSUNGEN LxPxH cm

**92x68x124 h**

## Carrelli portabiancheria, pulizia, multiuso - Laundry, cleaning, multipurpose trolley

## Chariots porte-linge, Nettoyage, Multi-usage - Wagen für Wäschereien, Reinigungsbetriebe, Mehrzweck

 Carrello multiuso completo di reggisacco, 2 secchi plastica lt.15. Strizzatore, Cassetta plastica media, 4 secchi lt.4, cestino portabottiglie. Ruote Ø 100, ganci portascopo, vano centrale con cassetto scorrevole.

 Multipurpose trolley with sack holder, 2 plastic buckets lt.15. Wringer, medium size plastic container, 4 buckets capacity lt.4, bottle rack. Wheels Ø 100, broom hooks, central space with sliding drawer.

 Chariot multiservice avec porte-sac, 2 seaux en plastique lt.15. Tordre-torchon, récipient en plastique moyenne, 4 seaux capacité 4 lt., porte-bouteilles. Roues Ø 100, crochets pour balais, compartiment centrale avec tiroir coulissant.

 Mehrzweckwagen mit Sackträger, 2 Plastikeimer lt.15. Wringer, mittlere Kunststoffbehälter, 4 Eimer Kapazität lt.4. Flaschenhalter, Räder Ø 100, Haken für Besen, zentralen Raum mit Schublade.





**NEW**

**CA 1616**

**€ 570,00**

DIMENSIONI ESTERNE - EXTERNAL DIMENSIONS LxPxH cm  
DIMENSIONS EXTERIEURES - AUßENABMESSUNGEN LxPxH cm

**133x68x124 h**

 Carrello multiuso in plastica -  Plastic multi-service trolley

 Chariot multi-service trolley -  Allzweckplastikwagen



**CA 1520**

**€ 260,00**

DIMENSIONI ESTERNE - EXTERNAL DIMENSIONS LxPxH cm  
DIMENSIONS EXTERIEURES - AUßENABMESSUNGEN LxPxH cm

**150x54x99 h**

 Cestone portabiancheria pieghevole con sacco in tela e ruote piroettanti.

 Folding laundry trolley with cloth bag and multidirectional wheels.

 Chariot pliable porte-linge avec sac en toile et roues rotatives.

 Klappbarer Wagen für Wäsche mit Wäschesack aus Gewebe und Drehbare Räder.



**CA 3203**

**€ 200,00**

DIMENSIONI ESTERNE - EXTERNAL DIMENSIONS LxPxH cm  
DIMENSIONS EXTERIEURES - AUßENABMESSUNGEN LxPxH cm

**62x64x100 h**

Sacco per CA 3203 - Sack for CA 3203 - Sac pour CA 3203 - Sack für CA 3203

**A 525**

**€ 45,00**

**Carrelli portabiancheria, pulizia, multiuso - Laundry, cleaning, multipurpose trolley**  
**Chariots porte-linge, Nettoyage, Multi-usage - Wagen für Wäschereien, Reinigungsbetriebe, Mehrzweck**

 Cesto pieghevole plastificato. Struttura in tubo e tondino di acciaio elettroverniciato. Ruote piroettanti.

 Plastic folding basket. White plasticized steel plate net container.

 Panier pliant plastifié. Conteneur pliable portelinge a grillage plastifié.

 Plastifizierter Klappkorb. Gestell aus elektrolakiertem Stahl.



**CA 1580**

**€ 94,00**

DIMENSIONI ESTERNE - EXTERNAL DIMENSIONS LxPxH cm  
 DIMENSIONS EXTERIEURES - AUßENABMESSUNGEN LxPxH cm

**80x52x72 h**



**CA 1588**

**€ 155,00**

DIMENSIONI ESTERNE - EXTERNAL DIMENSIONS LxPxH cm  
 DIMENSIONS EXTERIEURES - AUßENABMESSUNGEN LxPxH cm

**100x60x80 h**

**CA 1584**

**€ 225,00**

DIMENSIONI ESTERNE - EXTERNAL DIMENSIONS LxPxH cm  
 DIMENSIONS EXTERIEURES - AUßENABMESSUNGEN LxPxH cm

**100x60x87 h**

Sacco per CA 1584/1588 - Sack for CA 1584/1588  
 Sac pour CA 1584/1588 - Sack für CA 1584/1588

**A 531**

**€ 72,00**

Sacco per CA 1580 - Sack for CA 1580  
 Sac pour CA 1580 - Sack für CA 1580

**A 521**

**€ 68,00**







*Carrelli breakfast su ruote*   
*Carrelli portavalige e portabiti*  
*Reggivalige*  
*Aste delimita-corsie*  
*Macchina pulisci-scarpe*  
*Carrelli da trasporto pesante*

*Breakfast trolley on wheels*   
*Luggage and Clothing stands*  
*Luggage rack*  
*Lane poles*  
*Shoeshine machine*  
*Heavy load trolley*

*Chariots Petit-déjeuner sur roues*   
*Chariots porte-valises et porte-habits*  
*Porte-valises*  
*Tige de délimitation de passage*  
*Machine nettoyeuse de chaussures*  
*Chariots de transport pesant*

*Frühstückswagen auf Rädern*   
*Kofferwagen und Kleiderständerwagen*  
*Kofferhalter*  
*Bahnabgrenzungstangen*  
*Apparat zum Schuhe putzen*  
*Schwere Transportwagen*

## Carrelli breakfast su ruote - Breakfast trolley on wheels Chariots Petit-déjeuner sur roues - Frühstückswagen auf Rädern

- 
 Struttura portante in tubo di acciaio inox. Ripiano con antine ribaltabili, in legno rivestito in laminato color noce con bordo in gomma. Ripiano di servizio ruotabile sino a 90°, con possibilità di incastrare i carrelli uno dentro l'altro per ridurre al minimo l'ingombro. Ruote piroettanti (2 con freno).
- 
 Chromium plated steel tube frame. Shelf with rersible support, covered with laminated plastic brown and rubber lag. The service shelf may be turned up to 90°, thus making it possible to pile up trolleys one into the other, so as to reduce occupied space to a minimum. Swivelling wheels. Two wheels to brake.





**CB 980** € 390,00

**CB 980W** € 390,00

DIMENSIONI ESTERNE LxPxH cm  
EXTERNAL DIMENSIONS LxPxH cm  
DIMENSIONS EXTERIEURES LxPxH cm  
AUBENABMESSUNGEN LxPxH cm

**OPEN Ø80x80 h**  
**CLOSED 80x53x80 h**

- 
 Châssis porteur en tube d'acier chromé. Table avec antes à abat-tant, en bois revêtu de laminé plastique marron avec bord en caoutchouc. Le plain de dessert peut être ouvert jusqu'à 90° avec la possibilité d'enclaver les chariots l'un dans l'autre pour réduire l'encombrement au minimum. Roues pivotantes. Deux avec frein.
- 
 Gestell aus verchromtem Stahlrohr. Holzplatte mit kippbaren Flügeln, mit nußbaumfarbigem Laminat Verkleidet und Gummikante. Bis zu 90° drehbare Servierplatte; die Wagen können zur Platzeinsparnis ineinandergesteckt werden. Pirouettierende Rollen, 2 mit Bremse.



**CB 970** € 390,00

**CB 970W** € 390,00

DIMENSIONI ESTERNE LxPxH cm  
EXTERNAL DIMENSIONS LxPxH cm  
DIMENSIONS EXTERIEURES LxPxH cm  
AUBENABMESSUNGEN LxPxH cm

**OPEN 80x80x80 h**  
**CLOSED 80x53x80 h**



## Carrelli breakfast su ruote - Breakfast trolley on wheels Chariots Petit-déjeuner sur roues - Frühstückswagen auf Rädern

- 🇮🇹 CASSETTA TERMICA SCALDAPIATTI PER CARRELLI BREAKFAST. Costruita interamente in acciaio inox. Resistenza elettrica W 250 - V 230. Termostato regolabile 0°-90°.
- 🇬🇧 PLATE WARMING THERMAL CASE FOR BREAKFAST TROLLEY. Entirely stainless steel. Electric resistance W 250 V 230. Adjustable thermostat 0°-90°.
- 🇫🇷 BOÎTIER THERMIQUE CHAUFFE-PLATS POUR CHARIOTS PETIT-DÉJEUNER. Entièrement en acier inoxydable. Résistance électrique W 250 V 230. Thermostat réglable 0°-90°.
- 🇩🇪 THERMOKASTEN ZUM ERWÄRMEN DES GESCHIRRS FÜR FRÜHSTÜCKWAGEN. Komplett aus rostfreiem Stahl. Elektrischer Widerstand: W 250 - 230 V. Regulierbares Thermostat: 0°-90°.



**CST 300**

**€ 360,00**

DIMENSIONI ESTERNE LxPxH cm  
EXTERNAL DIMENSIONS LxPxH cm  
DIMENSIONS EXTERIEURES LxPxH cm  
AUBENABMESSUNGEN LxPxH cm

**39x37x46 h**

- 🇮🇹 Struttura in tubi acciaio inox da mm 25x25. Con guide per contenere n. 6 cassette termiche. Mod. CST 300 con relative prese elettriche. Assorbimento massimo 1500 W 230 V 50/60Hz. Con ruote Ø125 di cui 2 con freno.
- 🇬🇧 Stainless steel structure mm 25x25. Runners for no.6 thermal boxes mod.CST300 and their sockets. Maximum absorption 1500 W 230 V 50/60Hz. Wheels Ø 125, 2 of which with brake.
- 🇫🇷 Structure en acier inox mm 25x25. Glissières pour no.6 boîtes thermiques mod. CST300 et leur prises électriques. Absorption maximale 1500 W 230 V 50/60Hz. Roues Ø 125, dont 2 avec frein.
- 🇩🇪 Gestell aus rostfreiem Stahl mm 25x25. Schienen fuer Nr. 6 Thermokasten Mod.CST300 und Ihre Steckdosen. Maximale Netzspannung 1500 W 230 V 50/60Hz. Raeder Ø 125, 2 davon mit Bremse.



Carrello porta cassette termiche con presa elettrica  
Trolley with socket for thermal boxes  
Chariot porte-boîtes thermiques avec prise électrique  
Wagen fuer Thermokasten mit Steckdose

**CPC 600**









**€ 400,00**

DIMENSIONI ESTERNE LxPxH cm  
EXTERNAL DIMENSIONS LxPxH cm  
DIMENSIONS EXTERIEURES LxPxH cm  
AUBENABMESSUNGEN LxPxH cm

**155x61x132 h**

## Carrelli portavalige e portabiti - Luggage and Clothing stands

### Chariots porte-valises et porte-habits - Kofferwagen und Kleiderständerwagen

-  PORTAVALIGE CON APPENDIABITI. Base in legno ricoperta da moquette. Supporto asta in tubolare di acciaio ottonato, sezione Ø mm 40. Bordo paracolpi perimetrale in gomma. Ruote Ø mm 175, piroettanti.
-  LUGGAGE TROLLEY WITH CLOTHING STANDS. Wood base covered with moquette. Bar support made of brass coated tubular steel Ø mm 40. Rubber buffer edge 4 wheels Ø 175 mm multidirectional.
-  PORTE-VALISES AVEC PORTE-MANTEAUX. Base en bois couverte en moquette. Supporte barre tubolaire en acier cuivré Ø 40 mm. Butoir périmétrale en gomme. Roues Ø 175 mm pivotantes.
-  KOFFERWAGEN MIT KLEIDERSTÄNDER. Untergestell aus Holz mit Teppichbodenbelag. Stützstange aus vermessingtem Stahlrohr Ø mm 40. Stoßfester Gummirand. Rollen Ø mm 175, drehbare.
-  PORTAVALIGE CON APPENDIABITI. Base in legno ricoperta da moquette. Supporto asta in tubolare di acciaio cromato, sezione Ø mm 40. Bordo paracolpi perimetrale in gomma. Ruote Ø mm 175, piroettanti.
-  LUGGAGE TROLLEY WITH CLOTHING STANDS. Wood base covered with moquette. Bar support made of chromed tubular steel Ø mm 40. Rubber buffer edge 4 wheels Ø 175 mm multidirectional.
-  PORTE-VALISES AVEC PORTE-MANTEAUX. Base en bois couverte en moquette. Supporte-barre tubolaire en acier chromé Ø 40 mm. Butoir périmétrale en gomme. Roues Ø 175 mm pivotantes.
-  KOFFERWAGEN MIT KLEIDERSTÄNDER. Untergestell aus Holz mit Teppichbodenbelag. Stützstange aus verchromtem Stahlrohr Ø 40 mm. Stoßfester Gummirand. Rollen Ø mm 175, drehbare.



**PV 4062**

**€ 860,00**

DIMENSIONI ESTERNE - EXTERNAL DIMENSIONS LxPxH cm  
DIMENSIONS EXTERIEURES - AUßENABMESSUNGEN LxPxH cm

**95x55x190 h**

**PV 4064**

**€ 830,00**

DIMENSIONI ESTERNE - EXTERNAL DIMENSIONS LxPxH cm  
DIMENSIONS EXTERIEURES - AUßENABMESSUNGEN LxPxH cm

**95x55x190 h**

## Carrelli portavalige e portabiti - Luggage and Clothing stands Chariots porte-valises et porte-habits - Kofferwagen und Kleiderständerwagen

- PORTAVALIGE CON APPENDIABITI. Base in legno ricoperta da moquette. Supporto asta in tubolare di acciaio ottonato, sezione Ø mm 40. Bordo paracolpi perimetrale in gomma. Ruote Ø mm 175, piroettanti.
- LUGGAGE TROLLEY WITH CLOTHING STANDS. Wood base covered with moquette. Bar support made of brass coated tubular steel Ø mm 40. Rubber buffer edge 4 wheels Ø 175 mm multidirectional.
- PORTE-VALISES AVEC PORTE-MANTEAUX. Base en bois couverte en moquette. Supporte-barre tubolaire en acier cuivré Ø 40 mm. Butoir périmétrale en gomme. Roues Ø 175 mm pivotantes.
- KOFFERWAGEN MIT KLEIDERSTÄNDER. Untergestell aus Holz mit Teppichbodenbelag. Stützstange aus vermessingtem Stahlrohr Ø mm 40. Stoßfester Gummirand. Rollen Ø mm 175, drehbare.
- PORTAVALIGE CON APPENDIABITI. Base in legno ricoperta da moquette. Supporto asta in tubolare di acciaio cromato, sezione Ø mm 40. Bordo paracolpi perimetrale in gomma. Ruote Ø mm 175, piroettanti.
- LUGGAGE TROLLEY WITH CLOTHING STANDS. Wood base covered with moquette. Bar support made of chromed tubular steel Ø mm 40. Rubber buffer edge 4 wheels Ø 175 mm multidirectional.
- PORTE-VALISES AVEC PORTE-MANTEAUX. Base en bois couverte en moquette. Supporte barre tubolaire en acier chromé Ø 40 mm. Butoir périmétrale en gomme. Roues Ø 175 mm pivotantes.
- PORTE-VALISES AVEC PORTE-MANTEAUX. Base en bois couverte en moquette. Supporte barre tubolaire en acier chromé Ø 40 mm. Butoir périmétrale en gomme. Roues Ø 175 mm pivotantes.



**PV 4055**

**€ 730,00**

DIMENSIONI ESTERNE - EXTERNAL DIMENSIONS LxPxH cm  
DIMENSIONS EXTERIEURES - AUßENABMESSUNGEN LxPxH cm

**95x55x183 h**

**PV 4056**

**€ 670,00**

DIMENSIONI ESTERNE - EXTERNAL DIMENSIONS LxPxH cm  
DIMENSIONS EXTERIEURES - AUßENABMESSUNGEN LxPxH cm

**95x55x183 h**

## Carrelli portavalige e portabiti - Luggage and Clothing stands

### Chariots porte-valises et porte-habits - Kofferwagen und Kleiderständerwagen

 Carrello portavaligie con appendiabiti in acciaio ottonato o acciaio inox con pianale in legno ricoperto di moquette, ruote Ø 200 mm.

 Luggage trolley with brass painted steel clothing stands or stainless steel and with a wooden base covered with moquette. 200 Ø wheels.

 Porte-valises avec porte-manteaux en acier couleur cuivre o acier inox. Base en bois couverte en moquette. Roues Ø 200.

 Kofferwagen mit Kleiderständer aus Vermessingtem Stahl oder Edelstahl mit Boden aus Holz mit Teppichbodenbelag. Rollen Ø 200 mm.



#### **PV 2001 (ottonato)**

**€ 900,00**

DIMENSIONI ESTERNE - EXTERNAL DIMENSIONS LxPxH cm  
DIMENSIONS EXTERIEURES - AUßENABMESSUNGEN LxPxH cm

**124x64x190 h**

#### **PV 2001I (inox)**

**€ 840,00**



DIMENSIONI ESTERNE - EXTERNAL DIMENSIONS LxPxH cm  
DIMENSIONS EXTERIEURES - AUßENABMESSUNGEN LxPxH cm

**124x64x190 h**

**IL CARRELLO VIENE SPEDITO IN KIT SMONTATO - THE TROLLEY IS DELIVERED DISMOUNTED  
LE CHEROIT EST LIVRÉ DEMONTÉ - DER WAGEN IST DEMONTIERT GELIEFERT**

## **Carrelli portavaligie e portabiti - Luggage and Clothing stands** **Chariots porte-valises et porte-habits - Kofferwagen und Kleiderständerwagen**

-  Carrello portavaligie con appendiabiti inacciaio ottonato o acciaio inox con pianale in legno ricoperto di moquette, ruote Ø 200mm pneumatiche.

 Luggage trolley with brass painted steel clothing stands or stainless steel and with a wooden base covered with moquette. 200 Ø pneumatic wheels.
-  Porte-valises avec porte-manteaux en acier couleurcuivre o acier inox. Base en bois couverte en moquette. Roues pneumatiques Ø 200.

 Kofferwagen mit Kleiderständer aus Vermessingtem Stahl oder Edelstahl mit Boden aus Holz mit Teppichbodenbelag. Pneumatische Rollen Ø 200 mm.



**PV 2021 (ottonato)**

**€ 980,00**

DIMENSIONI ESTERNE - EXTERNAL DIMENSIONS LxPxH cm  
DIMENSIONS EXTERIEURES - AUBENABMESSUNGEN LxPxH cm

**110x62x198 h**

**PV 2021 I (inox)**

**€ 920,00**

DIMENSIONI ESTERNE - EXTERNAL DIMENSIONS LxPxH cm  
DIMENSIONS EXTERIEURES - AUBENABMESSUNGEN LxPxH cm

**110x62x198 h**

**IL CARRELLO VIENE SPEDITO IN KIT SMONTATO - THE TROLLEY IS DELIVERED DISMOUNTED**  
**LE CHEROIT EST LIVRÉ DEMONTÉ - DER WAGEN IST DEMONTIERT GELIEFERT**

## Carrelli portavaligie e portabiti - Luggage and Clothing stands

### Chariots porte-valises et porte-habits - Kofferwagen und Kleiderständerwagen

 Carrello portavaligie in acciaio ottonato o inox a due ruote dia. 250 con piedi di appoggio base pieghevole pianali in legno ricoperti di moquette.

 Two 250 Ø wheels luggage trolley in brass painted steel or stainless steel equipped with support feet, folding base and wooden surfaces covered with moquette.

 Chariot porte-valises à deux roues Ø 250 en acier couleur cuivre ou inox. Pieds d'appui, base pliable et surfaces en bois couvertes en moquette.

 Kofferwagen aus Vermessingtem Stahl oder Edelstahl mit zwei Rollen Ø 250 mm mit Unterstützungfüsse, Klappbarem Boden und Oberfläche aus Holz mit Teppichbelag.

 Carrello portavaligie in acciaio ottonato o inox a due ruote Ø 250 con base pieghevole pianali in legno ricoperti di moquette.

 Two 250 Ø wheels luggage trolley in brass painted steel or stainless steel. Equipped with folding base and wooden surfaces covered with moquette.

 Chariot porte-valises à deux roues Ø 250 en acier couleur cuivre ou inox. Base pliable et surfaces en bois couvertes en moquette.

 Kofferwagen aus Vermessingtem Stahl oder Edelstahl mit zwei Rollen Ø 250 mm, Klappbarem Boden und Oberfläche aus Holz mit Teppichbelag.



**PV 2002 (ottonato)**

**€ 260,00**

DIMENSIONI ESTERNE - EXTERNAL DIMENSIONS LxPxH cm  
DIMENSIONS EXTERIEURES - AUßENABMESSUNGEN LxPxH cm

**56x83x123 h**



**PV 2003 (ottonato)**

**€ 220,00**

DIMENSIONI ESTERNE - EXTERNAL DIMENSIONS LxPxH cm  
DIMENSIONS EXTERIEURES - AUßENABMESSUNGEN LxPxH cm

**56x70x120 h**



**PV 2002 I (inox)**

**€ 230,00**

DIMENSIONI ESTERNE - EXTERNAL DIMENSIONS LxPxH cm  
DIMENSIONS EXTERIEURES - AUßENABMESSUNGEN LxPxH cm

**56x83x123 h**



**PV 2003 I (inox)**





**€ 185,00**

DIMENSIONI ESTERNE - EXTERNAL DIMENSIONS LxPxH cm  
DIMENSIONS EXTERIEURES - AUßENABMESSUNGEN LxPxH cm

**56x70x120 h**



## **Carrelli da trasporto pesante - Heavy load trolley** **Chariots de transport pesant - Schwere Transportwagen**

-  **CARRELLO PORTAVALIGE.** Struttura in acciaio verniciato. Piano inferiore rivestito in moquette. Ruote Ø mm 200. Due pivottanti e due fisse.
-  **LUGGAGE TROLLEY.** Painted steel framework. Lower shelf fitted with moquette lining. Wheels Ø mms 200, two fixed and two castors.
-  **CHARIOT PORTE-BAGAGES.** Châssis en acier verni. Etagère inférieure revêtue de moquette. Roues Ø mms 200, dant deux fixes et deux pivotantes.
-  **GEPÄCKWAGEN.** Struktur aus Lackiertem Stahl. Unterabstellfläche mit Moquettebelag verkleidet. Räder Ø 200 mm, davon 2 feste und 2 lenkbar.







**PV 748**

**€ 500,00**

DIMENSIONI ESTERNE - EXTERNAL DIMENSIONS LxPxH cm  
DIMENSIONS EXTERIEURES - AUBENABMESSUNGEN LxPxH cm

**143x70x102 h**

-  **CARRELLO PORTACASSE.** Struttura in tubo di acciaio verniciato a polveri epossidiche. Ruote Ø 200 pneumatiche. Portata kg 200.
-  **BOX TROLLEY.** Enamel coated steel frame. Wheels Ø 200. Loads Kg 200.
-  **CHARIOT PORTE-CAISSES.** Châssis porteur en tube d'acier verni à pondres époxydes. Roues Ø 200. Charge kg 200.
-  **KASTENWAGEN.** Stahlgestell mit Epoxydpulverbeschichtung. Rollen Ø 200. Tragfähigkeit: kg 200.



**CA 1473**

**€ 115,00**

DIMENSIONI ESTERNE - EXTERNAL DIMENSIONS LxPxH cm  
DIMENSIONS EXTERIEURES - AUBENABMESSUNGEN LxPxH cm

**50x45x105 h**

## Carrelli portavalige e portabiti - Luggage and Clothing stands

### Chariots porte-valises et porte-habits - Kofferwagen und Kleiderständerwagen

 Struttura in tubo di acciaio inox. Base in lamiera d'acciaio inox. Ruote Ø mm 140. 2 fisse, 2 piroettanti.

 Stainless steel frame. Stainless steel shelf. 2 swivelling wheels. 2 fixed wheels Ømm 140.

 Châssis porteur en tube d'acier inox. Base en acier inox. 2 roues fixes. 2 roues pivotantes Ø mm 140.

 Gestell aus Edelstahl. Untergestell aus rostfreiem Stahlblech. Rollen Ø 140 mm, 2 feste, 2 drehbare.

 Stender portabiti. Struttura in tubo di acciaio cromato. Asta allungabile cm 30 ogni lato. Ruote piroettanti.

 Clothing stand. Chromium-plated steel frame. Rod extendable 30 cm each side. Swivelling wheels.

 Chariot porte-habites. Châssis porteur en tube d'acier chromé. Tige allongable cm30 de chaque côté. Roues pivotantes.

 Kleiderständer. Gestell aus verchromtem Stahlrohr. 30 cm an beiden Seiten ausziehbare Stange. Pirouettierende Rollen.



**PVI 4024**

**€ 375,00**

DIMENSIONI ESTERNE - EXTERNAL DIMENSIONS LxPxH cm  
DIMENSIONS EXTERIEURES - AUßENABMESSUNGEN LxPxH cm

**100x56x160 h**



**ST 4060**

**€ 90,00**



DIMENSIONI ESTERNE LxPxH cm APERTO  
EXTERNAL DIMENSIONS LxPxH cm OPEN  
DIMENSIONS EXTERIEURES LxPxH cm OUVERT  
AUßENABMESSUNGEN LxPxH cm OFFEN



**210x53x152 h**

DIMENSIONI ESTERNE LxPxH cm CHIUSO  
EXTERNAL DIMENSIONS LxPxH cm CLOSED  
DIMENSIONS EXTERIEURES LxPxH cm FERMÉ  
AUßENABMESSUNGEN LxPxH cm VERSCHLOSSEN

**150x53x152 h**

## Reggivalige - Luggage rack Porte-valises - Kofferhalter

 Struttura in legno. Telo cotone.  
 Wood luggage rack. Cotton cloth.

 Structure en bois. Toile en coton.  
 Gestell aus Holz, Blatt aus Baumwollstoff



Faggio con sponda - Beech with side-wall  
Hêtre avec bande - Buchen mit Rand

**RE 4016**

**€ 52,00**



Faggio senza sponda - Beech without side-wall  
Hêtre sans bande - Buchen ohne Rand

**RE 4018**

**€ 52,00**

Noce con sponda - Walnut with side-wall  
Noyer avec bande - Nussbaum mit Rand

**RE 4017**

**€ 52,00**

Noce senza sponda - Walnut without side-wall  
Noyer sans bande - Nussbaum ohne Rand

**RE 4019**

**€ 52,00**

DIMENSIONI ESTERNE - EXTERNAL DIMENSIONS LxPxH cm  
DIMENSIONS EXTERIEURES - AUßENABMESSUNGEN LxPxH cm

**50x46x58 h**

DIMENSIONI ESTERNE - EXTERNAL DIMENSIONS LxPxH cm  
DIMENSIONS EXTERIEURES - AUßENABMESSUNGEN LxPxH cm

**50x41x58 h**

## Carrelli da trasporto pesante - Heavy load trolley

### Chariots de transport pesant - Schwere Transportwagen

 **CARRELLO CON PIANALE BASSO.** Pianale in lamiera di acciaio inox. Manico smontabile. Ruote Ø 140 di cui 2 fisse e 2 girevoli.

 **LOW PLATFORM TROLLEY.** Platform in stainless steel. Removable tubular stainless steel handle-bar. n. 2 swivelling wheels and 2 fixed wheels Ø 140.

 **CHARIOT AVEC PLATE-FORME BASSE.** Platte-forme en acier inox. Manche en tube inox démontable. 2 roues fixes, 2 roues pivotantes Ø 140.

 **WAGEN MIT NIEDRIGER PLATTFORM.** Wagen mit niedriger Platte aus rostfreiem Stahllaminat. Abmontierbarer Griff 2 feste und 2 drehbare Rollen von Ø 140.



**CPB 1474**

**€ 300,00**

DIMENSIONI ESTERNE - EXTERNAL DIMENSIONS LxPxH cm  
DIMENSIONS EXTERIEURES - AUßENABMESSUNGEN LxPxH cm

**61x122x90 h**



Con doppio manico - With double handle  
Avec poignée double - Mit Doppelgriff

**CPB 1472**

**€ 335,00**

DIMENSIONI ESTERNE - EXTERNAL DIMENSIONS LxPxH cm  
DIMENSIONS EXTERIEURES - AUßENABMESSUNGEN LxPxH cm

**56x110x85 h**

### Optionals

**A 518**

Ruote con freno - Wheels with catch - Roues avec frein - Räder mit Bremse

**€ 20,00 cad./each**

## **Macchina pulisci-scarpe - Shoeshine machine** **Machine nettoyeuse de chaussures - Apparat zum Schuhe putzen**

- Struttura in lamiera verniciata a polveri epossidiche. Spazzole in cotone e crine. Dispensatore per crema. Motore elettrico V 230 50 Hz 150 W. Pulsante di accensione con temporizzatore elettrico.
- Painted steel structure. Cotton and horse hair brushes. Creme dispenser. Electric engine V 230 50 Hz 150 W. Switch with electrical timer.
- Structure en tôle vernie. Brosses en coton et crin. Dispensateur de crème. Moteur électrique V 230 50 Hz 150 W. Bouton d'allumage avec temporisateur électrique.
- Gestell aus Blech mit Epoxydharzbeschichtung. Bürsten aus Baumwolle und Roßhaar. Schumecremespendler. Elektromotor V 230 50 Hz 150 W.
- Struttura in lamiera verniciata a polveri epossidiche. Spazzole in cotone e crine. Motore elettrico V 230 50 Hz W 150. Pulsante di accensione con temporizzatore elettrico.
- Painted steel structure. Cotton and horse hair brushes. Electric engine V 230 50 Hz W 150 Switch with electrical timer.
- Structure en tôle vernie. Brosses en coton et crin. Moteur électrique V 230 50 Hz W 150. Bouton d'allumage avec temporisateur électrique.
- Gestell aus Blech mit Epoxydharzbeschichtung. Bürsten aus Baumwolle und Roßhaar. Elektromotor V 230 50 Hz W 150.



**LU 4120** Bianco - White **€ 720,00**

**LU 4120G** Grigio - Grey **€ 720,00**

DIMENSIONI ESTERNE - EXTERNAL DIMENSIONS LxPxH cm **62x30x83 h**  
DIMENSIONS EXTERIEURES - AUBENABMESSUNGEN LxPxH cm

**LU 4131** Bianco - White **€ 600,00**

**LU 4131G** Grigio - Grey **€ 600,00**

DIMENSIONI ESTERNE - EXTERNAL DIMENSIONS LxPxH cm **42x30x83 h**  
DIMENSIONS EXTERIEURES - AUBENABMESSUNGEN LxPxH cm

## Aste delimita-corsie - Lane poles

### Tige de délimitation de passage - Bahnabgrenzungsstangen



Altezza 100 cm  
Height 100 cm  
Hauteur 100 cm  
Höhe 100 cm

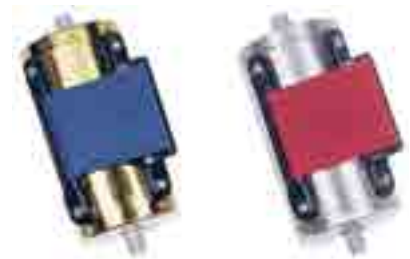

Asta dorata con nastro avvolgibile mt.2 Blu  
Golden bar with 2mt. blue roll up band  
Hampe dorée avec bande enroulable bleu 2mt.  
Vergoldete Stange mit aufwickelbarem Band 2mt. blau

**ACF5190DB**

**€ 80,00**

Puntale dorato con nastro blu  
Golden tip with blue band  
Embout dorée avec bande bleu  
Vergoldete Spitze mit blauem Band

**PU5195DB**

**€ 33,00**

Asta dorata con nastro avvolgibile mt.2 Rosso  
Golden bar with 2mt. red roll up band  
Hampe dorée avec bande enroulable rouge 2mt.  
Vergoldete Stange mit aufwickelbarem Band 2mt. rot

**ACF5190DR**

**€ 80,00**

Puntale dorato con nastro rosso  
Golden tip with red band  
Embout dorée avec bande rouge  
Vergoldete Spitze mit rotem Band

**PU5195DR**

**€ 33,00**

Asta inox lucido con nastro avvolgibile mt.2 Blu  
Polished s/s bar with 2mt. blue roll up band  
Hampe en acier inoxydable brillant avec bande enroulable bleu 2mt.  
Stange aus poliertem rostfreiem Stahl mit aufwickelbarem Band 2mt. blau

**ACF5190IB**

**€ 80,00**

Puntale inox lucido con nastro blu  
Polished s/s tip with blue band  
Embout en acier inoxydable brillant avec bande bleu  
Spitze aus poliertem rostfreiem Stahl mit blauem Band

**PU5195IB**

**€ 33,00**

Asta inox lucido con nastro avvolgibile mt.2 Rosso  
Polished s/s bar with 2mt. red roll up band  
Hampe en acier inoxydable brillant avec bande enroulable rouge 2mt.  
Stange aus poliertem rostfreiem Stahl mit aufwickelbarem Band 2mt. rot

**ACF5190IR**

**€ 80,00**

Puntale inox lucido con nastro rosso  
Polished s/s tip with red band  
Embout en acier inoxydable brillant avec bande rouge  
Spitze aus poliertem rostfreiem Stahl mit rotem Band

**PU5195IR**

**€ 33,00**

Asta nera con nastro avvolgibile mt.2 Blu  
Black bar with 2mt. blue roll up band  
Hampe noire avec bande enroulable bleu 2mt.  
Schwarze Stange mit aufwickelbarem Band 2mt. blau

**ACF5190NB**

**€ 80,00**

Puntale nero con nastro blu  
Black tip with blue band  
Embout noir avec bande blue  
Scharze Spitze mit blauem Band

**PU5195NB**

**€ 33,00**

Asta nera con nastro avvolgibile mt.2 Rosso  
Black bar with 2mt. red roll up band  
Hampe noire avec bande enroulable rouge 2mt.  
Schwarze Stange mit aufwickelbarem Band 2mt. rot

**ACF5190NR**

**€ 80,00**

Puntale nero con nastro rosso  
Black tip with red band  
Embout noir avec bande rouge  
Scharze Spitze mit rotem Band

**PU5195NR**

**€ 33,00**

## **Aste delimita-corsie - Lane poles** **Tige de délimitation de passage - Bahnabgrenzungsstangen**



Asta dorata delimita corsie per cordoni a treccia  
Golden bar for interlaced cords  
Hampe dorée pour cordons tressés  
Vergoldete Stange Bahnabgrenzungsstange für Zopfseile.

**AC 5118D**

**€ 80,00**

Asta inox lucido delimita corsie per cordoni a treccia  
Polished s/s bar for interlaced cords  
Hampe en acier inoxydable brillant pour cordons tressés  
Bahnabgrenzungsstange aus Poliertem rostfreiem Stahl für Zopfseile

**AC 5118I**

**€ 80,00**

Altezza 90 cm  
Height 90 cm  
Hauteur 90 cm  
Höhe 90 cm



Puntale dorato per cordoni  
Golden tip for cords  
Embout dorée pour cordons  
Vergoldete Spitze für Seile

**PU5144D**

**€ 15,00**

Puntale inox lucido per cordoni  
Polished s/s tip for cords  
Embout en acier inoxydable brillant pour cordons  
Spitze aus rostfreiem Poliertem Stahl für Seile

**PU5144I**

**€ 15,00**



Gancio a muro ottonato  
Brass painted wall hook  
Crochet à mur cuivré  
Vermessingter Wandhaken

**GA 5144D**

**€ 15,00**

Gancio a muro inox  
Stainless steel wall hook  
Crochet à mur en acier inoxydable  
Wandhaken aus rostfreiem Stahl

**GA 5144I**

**€ 15,00**



Cordone per aste - Cords for bars  
Cordes pour hampes - Seile für Stangen  
Colori: bordeaux, oro, verde, blu  
Colours: bordeaux, golden, green, blue

**C04099**

**€ 30,00** al metro - each meter

DIMENSIONI ESTERNE - EXTERNAL DIMENSIONS  
DIMENSIONS EXTERIEURES - AUBENABMESSUNGEN

**Ø 30 mm**





### ***Pattumiere e portarifuti***



***Posacenere gettacarta inox con coperchio a rete cromata***

***Gettacarte Autoestinguenta 50 lt.***

***Portarifuti carrellato con struttura a forma cilindrica in acciaio inox***

***Tramoggia su ruote costruita interamente in acciaio inox***

***Colorati per raccolta differenziata. Contenitore in polietilene litri 120. Ruote Ø 200***

### ***Garbage and dust bin***



***Stainless steel ash and paper-tray with chromium-plated wire net cover***

***Auto-extinguishing waste bin 50 lt.***

***Wheeled refuse bin with stainless steel cylindrical-shaped bin***

***Bin on castors, constructed entirely in satin-finish stainless steel***

***Coloured for recycling. Polyethylene container 120 litres. Wheels diam. 200***

### ***Boîtes à ordures et poubelles***



***Cendrier et pose-papier en acier inoxydable avec couvercle à grille, chromée***

***Pase-papier anti-feu 50 lt.***

***Poubelle sur roue avec structure de forme cylindrique, en acier inox***

***Trémie sur roues entièrement construite en acier inox***

***Colorées pour ramassage sélectif. Poubelle en polyéthylène 120 litres. Roulettes Ø 200***

### ***Abfallbehälter***



***Rostfreier Aschen-und Papierbecher mit verchromtem Gitterdekkel***

***Feuerlöschpapierbecher 50 lt.***

***Fahrbarern runder Abfalbehälter aus Edelstahl***

***Fahrbarer Behälter vollständig aus satiniertem Edelstahl konstruiert***

***Farbig für mülltrennung. Behälter aus polyäthylen 120 liter. Räder Ø 200***

## Pattumiere e portarifiuti - Garbage and dust bin Boîtes à ordures et poubelles - Abfallbehälter



-  Posacenere gettacarta inox con coperchio a rete cromata.
-  Stainless steel ash and paper-tray with chromium-plated wire net cover.
-  Cendrier et pose-papier en acier inoxydable avec couvercle à grille, chromée.
-  Rostfreier Aschen-und Papierbecher mit verchromtem Gitterdekkel.

**AV 4650**

**€ 90,00**

DIMENSIONI ESTERNE - EXTERNAL DIMENSIONS LxPxH cm  
DIMENSIONS EXTERIEURES - AUßENABMESSUNGEN LxPxH cm

**Ø 20 - 60 h**





**AV 4651**

**€ 140,00**

DIMENSIONI ESTERNE - EXTERNAL DIMENSIONS LxPxH cm  
DIMENSIONS EXTERIEURES - AUßENABMESSUNGEN LxPxH cm

**Ø 25 - 70 h**



-  Gettacarte Autoestinguente 50 lt. Acciaio inox satinato. Testa soffocante per l'arresto della propagazione del fuoco. Base in gomma.
-  Auto-extinguishing waste bin 50 lt. Brushed stainless steel. Self extinguishing top. Rubber round base.
-  Pase-papier anti-feu 50 lt. Acier inox satiné. Couvercle étouffe-feu. Base en caoutchouc.
-  Feuerlöschpapierbecher 50 lt. Satinedelstahl. Kopfe um das Feuer zu ersticken. Gummi-grund.





**AV 4620**

**€ 120,00**

DIMENSIONI ESTERNE - EXTERNAL DIMENSIONS LxPxH cm  
DIMENSIONS EXTERIEURES - AUßENABMESSUNGEN LxPxH cm

**Ø 31 - 59 h**



-  Tramoggia su ruote costruita interamente in Acciaio inox satinato con coperchio asportabile.
-  Bin on castors, constructed entirely in satin-finish stainless steel with removable lid.
-  Trémie sur roues entièrement construite en acier inox satiné avec couvercle amovible.
-  Fahrbarer Behälter vollständig aus satiniertem Edelstahl konstruiert, mit abnehmbaren Deckel.

**AV 4666**

**€ 370,00**

DIMENSIONI ESTERNE - EXTERNAL DIMENSIONS LxPxH cm  
DIMENSIONS EXTERIEURES - AUßENABMESSUNGEN LxPxH cm

**61x40x73 h**

Con separatore interno - With internal separator - Avec séparateur intérieur  
- Mit innerem Abscheider

**AV 4680**

**€ 420,00**

DIMENSIONI ESTERNE - EXTERNAL DIMENSIONS LxPxH cm  
DIMENSIONS EXTERIEURES - AUßENABMESSUNGEN LxPxH cm

**61x40x73 h**

## Pattumiere e portarifiuti - Garbage and dust bin Boîtes à ordures et poubelles - Abfallbehälter

 Colorati per raccolta differenziata. Contenitore in polietilene litri 100. Ruote Ø 143. Impilabile con ruote montate.

 Coloured for recycling. Polyethylene container 100 litres. Wheels diam. 143. Stackable with mounted wheels.

 Colorées pour ramassage sélectif. Poubelle en polyéthylène 100 litres. Roulettes Ø 143. Empilables avec roues montées.

 Farbige für Mülltrennung. Behälter aus Polyäthylen 100 Liter. Räder Ø 143. Stapelbar mit montierten Rädern.

 Colorati per raccolta differenziata. Contenitore in polietilene litri 120. Ruote Ø 200.

 Coloured for recycling. Polyethylene container 120 litres. Wheels diam. 200.

 Colorées pour ramassage sélectif. Poubelle en polyéthylène 120 litres. Roulettes Ø 200.

 Farbige für Mülltrennung. Behälter aus Polyäthylen 120 Liter. Räder Ø 200.



**NEW**

GRIGIO/GIALLO  
GREY/YELLOW



GRIGIO/BLU  
GREY/BLUE



GRIGIO/VERDE  
GREY/GREEN



GRIGIO/ROSSO  
GREY/RED

**AV 4682**

**€ 50,00**

DIMENSIONI ESTERNE - EXTERNAL DIMENSIONS LxPxH cm  
DIMENSIONS EXTERIEURES - AUßENABMESSUNGEN LxPxH cm

**54x49x85**



AV 4674 + RC0075



AV 4675



AV 4676



AV 4678



AV 4679

Colore bianco - White - Couleur blanche - Weiße Farbe

**AV 4674**

**€ 80,00**

DIMENSIONI ESTERNE - EXTERNAL DIMENSIONS LxPxH cm  
DIMENSIONS EXTERIEURES - AUßENABMESSUNGEN LxPxH cm

**55x48x93**

Pedale apricoperchio per contenitore - Opening pedal for the container's lid  
Pédale ouvre-couvercle pour conteneur - Deckelöffnerpedal fuer Behälter

**RC 0075 optional**

**€ 38,00**

## Pattumiere e portarifiuti - Garbage and dust bin Boîtes à ordures et poubelles - Abfallbehälter

- Portarifiuti carrellato con struttura a forma cilindrica in acciaio inox, completo di coperchio stampato, ruote piroettanti. Disponibile anche modello con comando a pedale, fondo a tenuta stagna.
- Wheeled refuse bin with stainless steel cylindrical-shaped bin, complete with moulded lid and castors. Pedal-controlled model also available, watertight bottom.



- Poubelle sur roue avec structure de forme cylindrique, en acier inox, complète de couvercle moulé, roues pivotantes. Une version avec commande à pédale peut être également livrée, fond étanche.
- Fahbarem runder Abfallbehälter aus Edelstahl, komplett mit gepreßtem Deckel und Lenkrollen. Auch als Modell mit Pedalbedienung verfügbar, Vollkommen undurchlaessig, Dicht des Bodens.



**AV 4667** € 200,00

DIMENSIONI ESTERNE - EXTERNAL DIMENSIONS LxPxH cm  
DIMENSIONS EXTERIEURES - AUßENABMESSUNGEN LxPxH cm **Ø 39 x 60 h / 50 lt**

**AV 4669** € 180,00

DIMENSIONI ESTERNE - EXTERNAL DIMENSIONS LxPxH cm  
DIMENSIONS EXTERIEURES - AUßENABMESSUNGEN LxPxH cm **Ø 46 x 70 h / 100 lt**

**AV 4668** € 230,00

DIMENSIONI ESTERNE - EXTERNAL DIMENSIONS LxPxH cm  
DIMENSIONS EXTERIEURES - AUßENABMESSUNGEN LxPxH cm **Ø 46 x 70 h / 100 lt**



- Pattumiere tonde in acciaio inox con cestello interno in metallo e pedale.
- Stainless steel round dust-bins. Metal inside basket and pedal.
- Poubelle ronde en acier inoxydable. Panier intérieur en metal et pédale.
- Runde Abfalleimer aus rostfreiem Stahl mit internem Eimer aus Metal und Fußhebel.

**AV 4660** € 180,00

DIMENSIONI ESTERNE - EXTERNAL DIMENSIONS LxPxH cm  
DIMENSIONS EXTERIEURES - AUßENABMESSUNGEN LxPxH cm **Ø 32-59 h / 30 lt**





**AV 4661** € 185,00

DIMENSIONI ESTERNE - EXTERNAL DIMENSIONS LxPxH cm  
DIMENSIONS EXTERIEURES - AUßENABMESSUNGEN LxPxH cm **Ø 32-74 h / 40 lt**

**AV 4663** € 315,00

DIMENSIONI ESTERNE - EXTERNAL DIMENSIONS LxPxH cm  
DIMENSIONS EXTERIEURES - AUßENABMESSUNGEN LxPxH cm **Ø 41-71 h / 80 lt**

**Pattumiere e portarifiuti - Garbage and dust bin**  
**Boîtes à ordures et poubelles - Abfallbehälter**

-  Con ruote, senza pedale e secchio interno.
-  With wheels, without pedal and internal bucket.
-  Avec roues, sans pédale ni seau interne.
-  Mit Räder, ohne Pedal und Inneneimer.







**AV 4671**

**€ 215,00**

DIMENSIONI ESTERNE - EXTERNAL DIMENSIONS LxPxH cm  
 DIMENSIONS EXTERIEURES - AUßENABMESSUNGEN LxPxH cm

**Ø 39-60 h / 63 lt**

-  Pattumiera rettangolare inox con 2 ruote e pedale. Estrazione sacco anteriore.
-  Stainless steel rectangular dust-bins. 2 wheels and pedale. Front sack extraction.
-  Poubelle rectangulaire en acier inoxydable. 2 roues et pédale. Ex-traction du sac antérieur.
-  Rechteckige Abfalleimer aus rostfreiem Stahl. 2 Räder und Fußhe-bel. Vordener, herausnehmbarer Sack.



**AV 4652**

**€ 350,00**

DIMENSIONI ESTERNE - EXTERNAL DIMENSIONS LxPxH cm  
 DIMENSIONS EXTERIEURES - AUßENABMESSUNGEN LxPxH cm

**49x50x101 h / 100 lt**





**AV 4654**

**€ 290,00**

DIMENSIONI ESTERNE - EXTERNAL DIMENSIONS LxPxH cm  
 DIMENSIONS EXTERIEURES - AUßENABMESSUNGEN LxPxH cm

**49x50x79 h / 70 lt**

## ***Pattumiere e portarifiuti - Garbage and dust bin Boîtes à ordures et poubelles - Abfallbehälter***

-  Pattumiera porta sacco rifiuti grande, attacco rotondo in acciaio inox, con coperchio con apertura a pedale.
-  Stainless steel dustbin for big waste sacks, round fastening, with pedal opening cover.
-  Poubelle en acier inoxydable pour sacs à déchets grands, fermeture ronde, avec couvercle ouvrable par pédale.
-  Abfalleimer aus Edelstahl für große Abfallsäcke, runde Befestigung, mit Deckel und Pedalöffnung.







**AV 4681**

**€ 185,00**

DIMENSIONI ESTERNE - EXTERNAL DIMENSIONS LxPxH cm  
DIMENSIONS EXTERIEURES - AUßENABMESSUNGEN LxPxH cm

**55x45x85**

-  Carrello "X" portasacco verniciato, attacco rotondo, coperchio in plastica rotondo con aggancio, cestino portaoggetti plastificato.
-  "X" trolley. Polished sack holder, round connection. Round plastic cover with hook. Plasticized basket.
-  Chariot "X" porte-sacs verni, point d'attache rond. Couvercie rond en plastique avec crochet. Panier porte-object plastifié.
-  Lackierter Waeschesackwagen "X", runde Sackhalterung, runder Kunststoffdeckel mit Hakenkunststoffbeschichteter Korb.



**CA 1602 verniciato con cestino**

**€ 150,00**

**CA 1603 cromato con pedale**

**€ 170,00**

DIMENSIONI ESTERNE - EXTERNAL DIMENSIONS LxPxH cm  
DIMENSIONS EXTERIEURES - AUßENABMESSUNGEN LxPxH cm

**58x56x102 h**

**Chafing dishes gastronom**   
**Distributori per caffè, caffè caldo, bevande, cereali**  
**Zuppiera elettrica**  
**Fornello flambé a gas**  
**Elemento elettrico riscaldante**  
**Pasta combustibile**  
**Padella flambé**





**Chafing Dish**   
**Distributors for coffee, hot coffee, beverages, cereals**  
**Electric pan**  
**Copper flambé gas-lamp**  
**Electric heating element**  
**Fuel tubs**  
**Cuprum-stainless steel**

**Bain-marie**   
**Distributeurs de café, café chaud, boissons, céréales**  
**Réceptacle électrique**  
**Fourneau flambé à gas en cuivre**  
**Élément électrique chauffant**  
**Gel combustible**  
**Poêle flambé**

**Chafing Dish**   
**Distributoren für Kaffee, heißen Kaffee, Getränke, Getreide**  
**Elektrische wanne**  
**Flambégas aus Kupper**  
**Elektrische Heizapparat**  
**Brennpaste**  
**Flambépfanne**

## Chafing dishes gastronorm - Chafing Dish

### Bain-marie - Chafing Dish

-  Chafing dish con coperchio. Rettangolare in acciaio inox con bruciatori ad alcool.
-  Chafing dish with lid. Rectangular in s/s with alcohol burners.
-  Bain-marie avec couvercle. Rectangulaire en acier inoxydable avec brûleurs à alcool.
-  Chafing Dish mit Deckel. Rechteckiges aus Edelstahl mit Alkohol Brenner.







**CD 7905**

**€ 100,00**

DIMENSIONI ESTERNE - EXTERNAL DIMENSIONS LxPxH cm  
DIMENSIONS EXTERIEURES - AUßENABMESSUNGEN LxPxH cm

**67x37x41 h**

-  Chafing dish con coperchio roll top in acciaio inox lucido con bruciatori ad alcool.
-  Chafing dish with polisher stainless, roll top steel lid with alcohol burners.
-  Bain-marie avec couvercle, roll top en acier inoxydable brillant avec brûleurs à alcool.
-  Chafing Dish mit Deckel, Roll top aus poliertem Edelstahl mit Alkohol Brenner.







**CD 9801**

**€ 238,00**

DIMENSIONI ESTERNE - EXTERNAL DIMENSIONS LxPxH cm  
DIMENSIONS EXTERIEURES - AUßENABMESSUNGEN LxPxH cm

**65x47x45 h**

**Optional resistenza elettrica (vedi pag. 170) - On demand electric resistance (see page 170)**  
**Sur demande résistance électrique (voir page 170) - Auf Anfrage elektrischen Widerstand (sehen Sie Seite 170)**

-  Chafing dish con coperchio roll top 180° in acciaio inox lucido con bruciatori ad alcool.
-  Chafing dish with roll top lid 180° in polished s/s with alcohol burners.
-  Bain-marie avec couvercle, roll top 180° en acier inoxydable brillant avec brûleurs à alcool.
-  Chafing Dish mit Deckel, Roll top 180° aus poliertem Edelstahl mit Alkohol Brenner.







**CD 6502**

**€ 430,00**

DIMENSIONI ESTERNE - EXTERNAL DIMENSIONS LxPxH cm  
DIMENSIONS EXTERIEURES - AUßENABMESSUNGEN LxPxH cm

**65x47x45 h**

-  Chafing dish tondo con coperchio roll top 180° in acciaio inox lucido con bruciatori ad alcool.
-  Round chafing dish with roll top lid 180° in polished s/s with alcohol burners.
-  Rond bain-marie avec couvercle roll top 180° en acier inoxydable brillant avec brûleurs à alcool.
-  Rundes Chafing Dish mit Deckel Roll top 180° aus poliertem Edelstahl mit Alkohol Brenner.



**CD 6504**

**€ 395,00**

DIMENSIONI ESTERNE - EXTERNAL DIMENSIONS LxPxH cm  
DIMENSIONS EXTERIEURES - AUßENABMESSUNGEN LxPxH cm

**50x52x45 h**



## Chafing dishes gastronorm, Distributori, Zuppiera elettrica - Chafing Dish, Distributors, Electric pan Bain-marie, Distributeurs, Récipient électrique - Chafing Dish, Distributoren, Elektrische wanne

- 🇮🇹 Chafing dish con coperchio roll top 180° con pentole Lt. 4,6 in acciaio inox lucido con bruciatori ad alcool.
- 🇬🇧 Chafing dish with roll top lid 180° with cookers Lt. 4,6 in polished s/s with alcohol burners.
- 🇫🇷 Bain-marie avec couvercle roll top 180° avec casseroles Lt. 4,6 en acier inoxydable brillant avec brûleurs à alcool.
- 🇩🇪 Chafing mit Roll Dish Top Deckel 180° mit Töpfe Lt. 4,6 aus poliertem Edelstahl mit Alkohol Brenner.



**CD 6505**

**€ 500,00**

DIMENSIONI ESTERNE - EXTERNAL DIMENSIONS LxPxH cm  
DIMENSIONS EXTERIEURES - AUßENABMESSUNGEN LxPxH cm

**65x47x45 h**

- 🇮🇹 DISTRIBUTORE CAFFÈ. Distributore inox per bevande calde Lt 9 con bruciatore ad alcool.
- 🇬🇧 COFFEE DISTRIBUTOR. Distributor in s/s for hot beverages Lt. 9 with alcohol burner.



- 🇫🇷 DISTRIBUTEUR À CAFÉ. Distributeur en acier inox pour boissons Lt. 9 chaudes avec brûler à alcool.

- 🇩🇪 KAFFEESTENDER. Spender aus rostfreiem Stahl für warme Getränke Lt. 9 mit Alkohol Brenner.

**DC 10502**

**€ 270,00**

DIMENSIONI ESTERNE - EXTERNAL DIMENSIONS LxPxH cm  
DIMENSIONS EXTERIEURES - AUßENABMESSUNGEN LxPxH cm

**33x24x54 h**

**Optional resistenza elettrica (vedi pag. 170) - On demand electric resistance (see page 170)  
Sur demande résistance électrique (voir page 170) - Auf Anfrage elektrischen Widerstand (sehen Sie Seite 170)**

- 🇮🇹 ZUPPIERA ELETTRICA. Zuppiera elettrica Lt 10 600 W 230 V. Corpo in alluminio verniciato epossidico. Contenitore e coperchio inox.



- 🇬🇧 ELECTRIC PAN. Electric pan Lt 10 600W 230V. Frame in painted aluminium epoxy. Container and lid in stainless steel.

- 🇫🇷 RÉCIPENT ÉLECTRIQUE. Récipient électrique Lt 10 600W 230V. Structure en aluminium verni époxyde. Cuvette et couvercle en acier inox.

- 🇩🇪 ELEKTRISCHE WANNE. Elektrische Wanne Lt 10 600W 230V Aufbau aus epoxy lackiertem Aluminium Behälter und Deckel aus Edelstahl.

**B 8001**

**€ 220,00**

DIMENSIONI ESTERNE - EXTERNAL DIMENSIONS LxPxH cm  
DIMENSIONS EXTERIEURES - AUßENABMESSUNGEN LxPxH cm

**Ø 35x36 h**

- 🇮🇹 DISTRIBUTORE CALDO PER CAFFÈ. Struttura in ABS con copertura in acciaio inox. Capacità Lt. 6,8 (circa 40 tazzine). Alimentazione 230V 50Hz 1100W. Dotato di termica di sicurezza. Temperatura 90°C.

- 🇬🇧 WARNING DISTRIBUTOR FOR COFFEE. ABS astructure covered with stainless steel. Capacity 6,8 Lt. ( 40 coffee cups approx.). Power supply 230V 50 Hz 1100W. Equipped with safety thermic protector. Temperature 90°C.



- 🇫🇷 DISTRIBUTEUR CHAUFFANT POUR CAFÉ. Structure en ABS plaquée en acier inox. Capacité 6,8 Lt. (40 tasses à café environ). Alimentation 230V 50Hz 1100W. Equipé de protection thermique de sécurité. Temperature 90°C.

- 🇩🇪 HEIZSPENDER FÜR KAFFEE. Struktur aus ABS verkleidet mit Edelstahl. Kapazität 6,8 Lt. (40 Kaffee-Tassen zirka). Anschluss 230V 50Hz 1100W. Sicherheitsthermoschutz. Temperatur 90°C.

**DCN 1706**





**€ 140,00**

DIMENSIONI ESTERNE - EXTERNAL DIMENSIONS LxPxH cm  
DIMENSIONS EXTERIEURES - AUßENABMESSUNGEN LxPxH cm

**Ø 29x44 h**

## Distributori - Distributors Distributeurs - Distributoren



-  **DISTRIBUTORE CEREALI.** Distributore inox con contenitore trasparente Lt. 8 neutro per cereali.
-  **CEREALS DISTRIBUTOR.** S/s distributor for cereals. Equipped with a 8 lt transparent container.
-  **DISTRIBUTEUR DE CÉRÉALES.** Distributeur en acier inoxydable pour céréales avec conteneur transparent, capacité: 8 tl.
-  **GETREIDESPENDER.** Spender aus rostfreiem Stahl mit transparentem Behälter für Getreide.





**DC 10301**

**€ 175,00**

DIMENSIONI ESTERNE - EXTERNAL DIMENSIONS LxPxH cm  
DIMENSIONS EXTERIEURES - AUßENABMESSUNGEN LxPxH cm

**36x26x66 h**



-  Distributore cereali doppio Lt. 8+8
-  Double cereals distributor Lt. 8+8
-  Distributeur double de céréales Lt. 8+8
-  Doppel Getreidespender Lt. 8+8





**DC 10302**

**€ 330,00**

DIMENSIONI ESTERNE - EXTERNAL DIMENSIONS LxPxH cm  
DIMENSIONS EXTERIEURES - AUßENABMESSUNGEN LxPxH cm

**48x26x66 h**



-  **DISTRIBUTORE BEVANDE.** Distributore inox con contenitore trasparente lt. 8. Tubo centrale per contenimento ghiaccio.
-  **DISTRIBUTOR FOR BEVERAGES.** Distributor in s/s with transparent container lt. 8. Central pipe containing ice.
-  **DISTRIBUTEUR À BOISSONS.** Distributeur en acier inox avec conteneur transparent lt. 8. Tuyau central pour contenir la glace.
-  **GETRÄNKESPENDER.** Spender aus rostfreiem Stahl mit transparent Behälter lt. 8. Zentraler Rohr für Eis-Behaltung.





**DS 10401**

**€ 215,00**

DIMENSIONI ESTERNE - EXTERNAL DIMENSIONS LxPxH cm  
DIMENSIONS EXTERIEURES - AUßENABMESSUNGEN LxPxH cm

**27x22x58 h**







-  Distributore bevande doppio Lt. 5+5
-  Double beverages distributor Lt. 5+5
-  Distributeur double à boissons Lt. 5+5
-  Doppel Getränkespender Lt. 5+5

**DS 10402**

**€ 410,00**

DIMENSIONI ESTERNE - EXTERNAL DIMENSIONS LxPxH cm  
DIMENSIONS EXTERIEURES - AUßENABMESSUNGEN LxPxH cm

**35x32x58 h**

-  Forno flambé a gas in rame con griglia inox.
-  Copper flambé gas-lamp with stainless steel grill.
-  Fourneau flambé à gas en cuivre avec grille en acier inoxydable.
-  Flambégas aus Kopper mit Gitter aus rostfreiem Stahl.







**AV 4561**

**€ 305,00**

DIMENSIONI ESTERNE - EXTERNAL DIMENSIONS LxPxH cm  
DIMENSIONS EXTERIEURES - AUßENABMESSUNGEN LxPxH cm

**Ø 26x29,5 h**

-  Padella flambé inox-cuprum, manico legno.
-  Cuprum-stainless steel, flambé pan, wooden handle.
-  Poêle flambé. Acier inoxydable - cuprum, poignée en bois.
-  Flambépfanne. Cuprum-rostoffreiem Stahl. Handgriff aus Holz.



**AV 4580**

**€ 125,00**

DIMENSIONI ESTERNE - EXTERNAL DIMENSIONS LxPxH cm  
DIMENSIONS EXTERIEURES - AUßENABMESSUNGEN LxPxH cm





**Ø 29**

**AV 4581**

**€ 115,00**

DIMENSIONI ESTERNE - EXTERNAL DIMENSIONS LxPxH cm  
DIMENSIONS EXTERIEURES - AUßENABMESSUNGEN LxPxH cm

**Ø 26**





-  Pasta combustibile in barattolo da 200 g netto.
-  Fuel. In tins of 200 g (7 oz) net capacity.
-  Gel combustibile. En boite de 200 g net.
-  Brennpaste. In Dosen zu 200 g netto.



**AV 9303**

**€ 95,00**

Confezione n. 72 barattoli - Set of 72 cans  
Set de 72 boites - Verpackung 72 Dosen

-  Pasta combustibile in secchi da 4 kg netto.
-  Fuel tubs of 8.8 lb net capacity.
-  Gel combustibile, bidons de 4 kg net.
-  Brennpaste. In Kesseln zu 4 kg netto.







**AV 9300**

**€ 88,00**

Confezione n. 4 secchi / Set of 4 tubs  
Set de 4 bidons / Verpackung 4 Kesseln

## Accessori - Accessories Accessoires - Zubehör





-  Elemento elettrico riscaldante 180 W. Per DC 10502
-  Electric heating element 180 W. For DC 10502
-  Élément électrique chauffant 180 W. Pour DC 10502
-  Elektrische Heizapparat 180 W. Für DC 10502



**AV9517**

**€ 88,00**

Applicabile ai seguenti articoli - Available for the following items  
Disponible pour les articles suivant - Verfügbare für die folgende Artikel  
**DC10502**

-  Elemento di riscaldamento elettrico per Chafing Dishes 230 V 50/60 Hz 360 W.
-  Electric heating element for Chafing Dishes 230 V 50/60 Hz 360 W.
-  Élément électrique de chauffage pour Chafing Dishes 230 V 50/60 Hz 360 W.
-  Elektrischer Heizelement für Chafing Dishes 230 V 50/60 Hz 360 W.



**AV9516**

**€ 100,00**

Applicabile ai seguenti articoli - Available for the following items  
Disponible pour les articles suivant - Verfügbare für die folgende Artikel  
**CD 7905 - CD 9801 - CD 6502 - CD 6504 - CD 6505**

***Bacinelle gastronorm e vaschette per gelato***   
***Bacinelle gn in polycarbonato***  
***Accessori per cucina***  
***Accessori per pizzeria***  
***Bilancia elettronica***

***GN basins and ice cream drums***   
***GN pans in polycarbonate***  
***Kitchen accessories***  
***Accessories for pizzeria***  
***Electronic scale***

***Bacs Gastronorm et bacs à glace***   
***Bacs GN en polycarbonate***  
***Accessoires pour cuisines***  
***Accessoires pour pizzeria***  
***Bilance électronique***

***Gastronorm Schüssel und Eisschalen***   
***GN Polycarbonatbehälter***  
***Kochzubehöre***  
***Zubehör für Pizzerien***  
***Elektronische Waage***

**Bacinele gastronorm e vaschette per gelato AISI 304 (18/10) - GN basins and ice cream drums AISI 304 (18/10)**  
**Bacs Gastronom et bacs à glace AISI 304 (18/10) - Gastronom Schüssel und Eisschalen AISI 304 (18/10)**



| BACINELLE - CONTAINERS - CUVETTES - BEHÄLTER |  |  |   | dimensioni in mm - dimension in mm       |  |  |  |
|--|--|--|---|--|--|--|--|
| MOD. 2/1<br>EST. 646 x 530<br>INT. 620 x 500 |  | <b>GNI 21200</b> 200 h / 60 lt € 93,00   | <b>GNI 2140</b> 40 h / 12 lt € 43,00      |  |  |  |  |
|  |  | <b>GNI 21150</b> 150 h / 44,9 lt € 82,00 | <b>GNI 2120</b> 20 h / 6,5 lt € 38,00     |  |  |  |  |
|  |  | <b>GNI 21100</b> 100 h / 31,5 lt € 60,00 | <b>GRI 21</b> Griglia € 35,00             |  |  |  |  |
|  |  | <b>GNI 2165</b> 65 h / 18,9 lt € 46,00   |   |  |  |  |  |
| MOD. 1/1<br>EST. 530 x 325<br>INT. 500 x 300 |  | <b>GNI 11200</b> 200 h / 30 lt € 50,00   | <b>GNI 1140</b> 40 h / 5,5 lt € 21,00     | <b>FFF 11</b> Falso fondo forato € 19,00 |  |  |  |
|  |  | <b>GNI 11150</b> 150 h / 20,6 lt € 42,00 | <b>GNI 1120</b> 20 h / 2,5 lt € 18,00     | <b>GRI 11</b> Griglia € 19,00            |  |  |  |
|  |  | <b>GNI 11100</b> 100 h / 13,3 lt € 30,00 | <b>COPI 11</b> Coperchio € 16,00          | <b>S 530</b> Separatore € 6,00           |  |  |  |
|  |  | <b>GNI 1165</b> 65 h / 8,5 lt € 24,00    | <b>COPG 11</b> Coperchio a tenuta € 51,00 |  |  |  |  |
| MOD. 2/3<br>EST. 352 x 325<br>INT. 329 x 300 |  | <b>GNI 23200</b> 200 h / 19,3 lt € 34,00 | <b>GNI 2340</b> 40 h / 3,5 lt € 16,00     | <b>FFF 23</b> Falso fondo forato € 16,00 |  |  |  |
|  |  | <b>GNI 23150</b> 150 h / 13,6 lt € 29,00 | <b>GNI 2320</b> 20 h / 1,8 lt € 12,00     | <b>GRI 23</b> Griglia € 17,00            |  |  |  |
|  |  | <b>GNI 23100</b> 100 h / 8,9 lt € 24,00  | <b>COPI 23</b> Coperchio € 13,00          |  |  |  |  |
|  |  | <b>GNI 2365</b> 65 h / 5,5 lt € 18,00    | <b>COPG 23</b> Coperchio a tenuta € 38,00 |  |  |  |  |
| MOD. 1/2<br>EST. 325 x 265<br>INT. 300 x 238 |  | <b>GNI 12200</b> 200 h / 11,6 lt € 29,00 | <b>GNI 1240</b> 40 h / 2,5 lt € 12,00     | <b>FFF 12</b> Falso fondo forato € 11,00 |  |  |  |
|  |  | <b>GNI 12150</b> 150 h / 9,9 lt € 24,00  | <b>GNI 1220</b> 20 h / 1,2 lt € 10,00     | <b>S 325</b> Separatore € 5,00           |  |  |  |
|  |  | <b>GNI 12100</b> 100 h / 8 lt € 19,00    | <b>COPI 12</b> Coperchio € 10,00          |  |  |  |  |
|  |  | <b>GNI 1265</b> 65 h / 4,2 lt € 15,00    | <b>COPG 12</b> Coperchio a tenuta € 36,00 |  |  |  |  |
| MOD. 1/3<br>EST. 325 x 176<br>INT. 300 x 150 |  | <b>GNI 13200</b> 200 h / 8,1 lt € 23,00  | <b>GNI 1340</b> 40 h / 1,5 lt € 10,00     | <b>FFF 13</b> Falso fondo forato € 9,00  |  |  |  |
|  |  | <b>GNI 13150</b> 150 h / 5,9 lt € 20,00  | <b>GNI 1320</b> 20 h / 0,7 lt € 7,00      |  |  |  |  |
|  |  | <b>GNI 13100</b> 100 h / 3,8 lt € 15,00  | <b>COPI 13</b> Coperchio € 8,00           |  |  |  |  |
|  |  | <b>GNI 1365</b> 65 h / 2,5 lt € 12,00    | <b>COPG 13</b> Coperchio a tenuta € 31,00 |  |  |  |  |
| MOD. 1/4<br>EST. 265 x 162<br>INT. 238 x 136 |  | <b>GNI 14200</b> 200 h / 4,9 lt € 21,00  | <b>GNI 1440</b> 40 h / 1 lt € 8,00        | <b>S 265</b> Separatore € 5,00           |  |  |  |
|  |  | <b>GNI 14150</b> 150 h / 4,1 lt € 16,00  | <b>GNI 1420</b> 20 h / 0,5 lt € 6,00      |  |  |  |  |
|  |  | <b>GNI 14100</b> 100 h / 2,5 lt € 14,00  | <b>COPI 14</b> Coperchio € 7,00           |  |  |  |  |
|  |  | <b>GNI 1465</b> 65 h / 1,9 lt € 10,00    | <b>COPG 14</b> Coperchio a tenuta € 26,00 |  |  |  |  |
| MOD. 1/6<br>EST. 176 x 162<br>INT. 140 x 153 |  | <b>GNI 16200</b> 200 h / 3 lt € 25,00    | <b>COPI 16</b> Coperchio € 5,50           |  |  |  |  |
|  |  | <b>GNI 16150</b> 150 h / 2,5 lt € 15,00  | <b>COPG 16</b> Coperchio a tenuta € 25,00 |  |  |  |  |
|  |  | <b>GNI 16100</b> 100 h / 1,6 lt € 12,00  |   |  |  |  |  |
|  |  | <b>GNI 1665</b> 65 h / 1,1 lt € 10,00    |   |  |  |  |  |
| MOD. 1/9<br>EST. 176 x 108<br>INT. 140 x 100 |  | <b>GNI 19100</b> 100 h / 0,9 lt € 12,00  |   |  |  |  |  |
|  |  | <b>GNI 1965</b> 65 h / 0,5 lt € 9,00     |   |  |  |  |  |
|  |  | <b>COPI 19</b> Coperchio € 5,00          |   |  |  |  |  |

**Bacinelle gastronorm e vaschette per gelato AISI 304 (18/10) - GN basins and ice cream drums AISI 304 (18/10)**  
**Bacs Gastronom et bacs à glace AISI 304 (18/10) - Gastronom Schüssel und Eisschalen AISI 304 (18/10)**



**BACINELLE FORATE - PIERCED BASINS - CUVETTES PERCÉES - LOCHSCHALE**

dimensioni in mm - dimension in mm

|  |  |                  |                 |                 |
|--|--|------------------|-----------------|-----------------|
| MOD. 2/1<br>EST. 646 x 530<br>INT. 620 x 500 |  | <b>GNT 21200</b> | 200 h / 60 lt   | <b>€ 132,00</b> |
|  |  | <b>GNT 21150</b> | 150 h / 44,9 lt | <b>€ 115,00</b> |
|  |  | <b>GNT 21100</b> | 100 h / 31,5 lt | <b>€ 85,00</b>  |
|  |  | <b>GNT 2165</b>  | 65 h / 19,9 lt  | <b>€ 72,00</b>  |
| MOD. 1/1<br>EST. 530 x 325<br>INT. 500 x 300 |  | <b>GNT 11200</b> | 200 h / 30 lt   | <b>€ 66,00</b>  |
|  |  | <b>GNT 11150</b> | 150 h / 20,6 lt | <b>€ 53,00</b>  |
|  |  | <b>GNT 11100</b> | 100 h / 13,3 lt | <b>€ 40,00</b>  |
|  |  | <b>GNT 1165</b>  | 65 h / 8,5 lt   | <b>€ 30,00</b>  |
| MOD. 2/3<br>EST. 352 x 325<br>INT. 329 x 300 |  | <b>GNT 23200</b> | 200 h / 19,3 lt | <b>€ 44,00</b>  |
|  |  | <b>GNT 23150</b> | 150 h / 13,6 lt | <b>€ 37,00</b>  |
|  |  | <b>GNT 23100</b> | 100 h / 8,9 lt  | <b>€ 30,00</b>  |
|  |  | <b>GNT 2365</b>  | 65 h / 5,5 lt   | <b>€ 25,00</b>  |
| MOD. 1/2<br>EST. 325 x 265<br>INT. 300 x 238 |  | <b>GNT 12200</b> | 200 h / 11,6 lt | <b>€ 42,00</b>  |
|  |  | <b>GNT 12150</b> | 150 h / 9,9 lt  | <b>€ 33,00</b>  |
|  |  | <b>GNT 12100</b> | 100 h / 8 lt    | <b>€ 25,00</b>  |
|  |  | <b>GNT 1265</b>  | 65 h / 4,2 lt   | <b>€ 19,00</b>  |



**TEGLIE CON FONDO FORATO - PANS WITH PERFORATED BOTTOM**

dimensioni in mm - dimension in mm

|  |  |                 |                |                |
|--|--|-----------------|----------------|----------------|
| MOD. 2/1<br>EST. 646 x 530<br>INT. 620 x 500 |  | <b>GNF 2120</b> | 20 h / 6,5 lt  | <b>€ 41,00</b> |
|  |  | <b>GNF 2140</b> | 40 h / 12 lt   | <b>€ 45,00</b> |
|  |  | <b>GNF 2165</b> | 65 h / 18,9 lt | <b>€ 54,00</b> |
| MOD. 1/1<br>EST. 530 x 325<br>INT. 500 x 300 |  | <b>GNF 1120</b> | 20 h / 2,5 lt  | <b>€ 20,00</b> |
|  |  | <b>GNF 1140</b> | 40 h / 5,5 lt  | <b>€ 22,00</b> |
|  |  | <b>GNF 1165</b> | 65 h / 8,5 lt  | <b>€ 26,00</b> |
| MOD. 2/3<br>EST. 352 x 325<br>INT. 329 x 300 |  | <b>GNF 2320</b> | 20 h / 1,8 lt  | <b>€ 15,00</b> |
|  |  | <b>GNF 2340</b> | 40 h / 3,5 lt  | <b>€ 18,00</b> |
|  |  | <b>GNF 2365</b> | 65 h / 5,5 lt  | <b>€ 20,00</b> |
| MOD. 1/2<br>EST. 325 x 265<br>INT. 300 x 238 |  | <b>GNF 1220</b> | 20 h / 1,2 lt  | <b>€ 12,00</b> |
|  |  | <b>GNF 1240</b> | 40 h / 2,5 lt  | <b>€ 14,00</b> |
|  |  | <b>GNF 1265</b> | 65 h / 4,2 lt  | <b>€ 16,00</b> |

**Bacinele gastronorm e vaschette per gelato AISI 304 (18/10) - GN basins and ice cream drums AISI 304 (18/10)**  
**Bacs Gastronom et bacs à glace AISI 304 (18/10) - Gastronom Schüssel und Eisschalen AISI 304 (18/10)**



**VASCHE PER GELATO - BASINS FOR ICE-CREAM - BACS POUR GLACE - SCHALEN FÜR EIS**

dimensioni in mm - dimension in mm

|  |                  |   |        |                |
|--|------------------|---|--------|----------------|
|  | <b>VG 261612</b> | 260x165x120 h   | 3,5 lt | <b>€ 20,00</b> |
|  | <b>VG 261615</b> | 260x165x150 h   | 4,1 lt | <b>€ 23,00</b> |
|  | <b>VG 33168</b>  | 330x165x80 h  | 3,5 lt | <b>€ 20,00</b> |
|  | <b>VG 331612</b> | 330x165x120 h   | 5 lt   | <b>€ 23,00</b> |
|  | <b>VG 331615</b> | 330x165x150 h   | 6,5 lt | <b>€ 24,00</b> |
|  | <b>VG 36168</b>  | 360x165x80 h  | 3,8 lt | <b>€ 18,00</b> |
|  | <b>VG 361612</b> | 360x165x120 h   | 5,4 lt | <b>€ 19,00</b> |
|  | <b>VG 361615</b> | 360x165x150 h   | 7,1 lt | <b>€ 23,00</b> |
|  | <b>VG 361618</b> | 360x165x180 h   | 8,8 lt | <b>€ 26,00</b> |
|  | <b>VG 36258</b>  | 360x250x80 h  | 5 lt   | <b>€ 20,00</b> |
|  | <b>VG 362512</b> | 360x250x120 h   | 8 lt   | <b>€ 21,00</b> |
|  | <b>CR</b>        | Pozzetto inox per gelato - Stainless steel washers for ice - Crem portion |        |                |

**TEGLIE SMALTATE - ENAMEL TRAY GN 1/1**

|  |                 |             |                |
|--|-----------------|-------------|----------------|
|  | <b>GNS 1120</b> | GN 1/1 h 20 | <b>€ 63,00</b> |
|  | <b>GNS 1140</b> | GN 1/1 h 40 | <b>€ 70,00</b> |
|  | <b>GNS 1165</b> | GN 1/1 h 65 | <b>€ 74,00</b> |

**COPERCHI IN PLASTICA - PLASTIC COVERS - COUVERCLES EN PLASTIQUE - DECKEL AUS PLASTIK**

dimensioni in mm - dimension in mm

|  |             |         |               |
|--|-------------|---------|---------------|
|  | <b>CP 2</b> | 265x160 | <b>€ 9,00</b> |
|  | <b>CP 3</b> | 330x165 | <b>€ 9,00</b> |
|  | <b>CP 4</b> | 360x165 | <b>€ 9,00</b> |

**SPATOLA PER GELATO / SPATULE FOR ICE-CREM**

|  |            |  |               |
|--|------------|--|---------------|
|  | <b>SPG</b> | Spatola trasparente, rossa, blu, gialla - Manico 26 cm.a | <b>€ 6,00</b> |
|  |            |  |               |
|  |            |  |               |
|  |            |  |               |



**Bacinelle gn in policarbonato - GN pans in polycarbonate**  
**Bacs GN en polycarbonate - GN Polycarbonatbehälter**







dimensioni in mm - dimension in mm

|  |  |                  |                 |                |
|--|--|------------------|-----------------|----------------|
| MOD. 1/1<br>EST. 530 x 325<br>INT. 500 x 300 |  | <b>GNP 11200</b> | 200 h / 30 lt   | <b>€ 25,00</b> |
|  |  | <b>GNP 11150</b> | 150 / 20,6 lt   | <b>€ 21,00</b> |
|  |  | <b>GNP 11100</b> | 100 / 13,3 lt   | <b>€ 17,00</b> |
|  |  | <b>GNP 1165</b>  | 65 h / 8,5 lt   | <b>€ 14,00</b> |
|  |  | <b>COPP 11</b>   | 530x325         | <b>€ 10,00</b> |
|  |  | <b>GFP 11</b>    | 460x255         | <b>€ 8,00</b>  |
| MOD. 1/2<br>EST. 325 x 265<br>INT. 300 x 238 |  | <b>GNP 12200</b> | 200 h / 11,6 lt | <b>€ 15,00</b> |
|  |  | <b>GNP 12150</b> | 150 / 9,9 lt    | <b>€ 13,00</b> |
|  |  | <b>GNP 12100</b> | 100 h / 8 lt    | <b>€ 10,00</b> |
|  |  | <b>GNP 1265</b>  | 65 h / 4,2 lt   | <b>€ 8,00</b>  |
|  |  | <b>COPP 12</b>   | 325x265         | <b>€ 7,00</b>  |
|  |  | <b>GFP 12</b>    | 250x190         | <b>€ 5,00</b>  |
| MOD. 1/3<br>EST. 325 x 176<br>INT. 300 x 150 |  | <b>GNP 13200</b> | 200 h / 8,1 lt  | <b>€ 12,00</b> |
|  |  | <b>GNP 13150</b> | 150 h / 5,9 lt  | <b>€ 10,00</b> |
|  |  | <b>GNP 13100</b> | 100 h / 3,8 lt  | <b>€ 8,00</b>  |
|  |  | <b>GNP 1365</b>  | 65 h / 2,5 lt   | <b>€ 6,00</b>  |
|  |  | <b>COPP 13</b>   | 325x176         | <b>€ 5,00</b>  |
|  |  | <b>GFP 13</b>    | 250x110         | <b>€ 3,00</b>  |
| MOD. 1/4<br>EST. 265 x 162<br>INT. 238 x 136 |  | <b>GNP 14200</b> | 200 h / 4,9 lt  | <b>€ 11,00</b> |
|  |  | <b>GNP 14150</b> | 150 / 4,1 lt    | <b>€ 8,00</b>  |
|  |  | <b>GNP 14100</b> | 100 h / 2,5 lt  | <b>€ 6,00</b>  |
|  |  | <b>GNP 1465</b>  | 65 h / 1,9 lt   | <b>€ 5,00</b>  |
|  |  | <b>COPP 14</b>   | 265x162         | <b>€ 3,00</b>  |
|  |  | <b>GFP 14</b>    | 210x110         | <b>€ 3,00</b>  |
| MOD. 1/6<br>EST. 176 x 162<br>INT. 140 x 153 |  | <b>GNP 16200</b> | 200 h / 3,1 lt  | <b>€ 8,00</b>  |
|  |  | <b>GNP 16150</b> | 150 / 2,5 lt    | <b>€ 6,00</b>  |
|  |  | <b>GNP 16100</b> | 100 h / 1,6 lt  | <b>€ 5,00</b>  |
|  |  | <b>GNP 1665</b>  | 65 h / 1,1 lt   | <b>€ 4,00</b>  |
|  |  | <b>COPP 16</b>   | 176x162         | <b>€ 3,00</b>  |
|  |  | <b>GFP 16</b>    | 115x100         | <b>€ 2,00</b>  |
| MOD. 1/9<br>EST. 176 x 108<br>INT. 140 x 100 |  | <b>GNP 19100</b> | 100 h / 0,9 lt  | <b>€ 4,00</b>  |
|  |  | <b>GNP 1965</b>  | 65 h / 0,5 lt   | <b>€ 3,00</b>  |
|  |  | <b>COPP 19</b>   | 176x100         | <b>€ 3,00</b>  |
|  |  |                  |                 |                |
|  |  |                  |                 |                |





**CASSETTA SEMIFORATA**

dimensioni in mm - dimension in mm

|  |               |                     |                |
|--|---------------|---------------------|----------------|
|  | <b>AV4908</b> | 60x40x10 h - lt. 18 | <b>€ 12,00</b> |
|  |               |                     |                |
|  |               |                     |                |
|  |               |                     |                |
|  |               |                     |                |

-  **MORSA PER PROSCIUTTO.** Corpo in acciaio inox. Supporto e manici in legno pregiato.
-  **HAM VICE.** Stainless steel body. Fine wooden base and handles.
-  **ETAU POUR JAMBON.** Corps en acier inoxydable. Base et poignées en bois.
-  **SCHINKEN-EINSPANNUNG.** Gestell aus rostfreiem Stahl. Sockel und Handgriffe aus Holz.



-  **MORSA PER PROSCIUTTO.** Corpo in acciaio. Supporto e manici in legno.
-  **HAM VICE.** Steel body, wooden support and handles.
-  **ETAU POUR JAMBON.** Corps en acier inox. Support et manches en bois.
-  **SCHINKEN-EINSPANNUNG.** Gestell aus Stahl, Halterung und Griffe aus Holz.







**AV 4510** € 140,00

DIMENSIONI ESTERNE - EXTERNAL DIMENSIONS LxPxH cm  
 DIMENSIONS EXTERIEURES - AUßENABMESSUNGEN LxPxH cm

**58x25x19 h**

**AV 4515** € 45,00

-  **VASSOIO IN LAMINATO.** Disponibile solo in colore teak.
-  **LAMINATED MELAMINE TRAYS.** Available in teak version only.
-  **PLATEAUX STATIFIÉS EN MÉLAMINE.** Disponible seulement en version teak.
-  **TABLETTES AUS KUNSTSTOFF.** Verfügbar aus teak.



-  **APRISCATOLE DA BANCO.** Apparecchiatura in acciaio cementato. Coltello in acciaio inox. Alzacoperchi magnetico.
-  **TABLE TOP CAN OPENER.** Case-hardened steel appliance. Stainless steel knife. Magnetic cover lifter.
-  **OUVRE-BOÎTES DE TABLE.** Appareil en acier cémenté. Couteau en acier inoxydable. Soulèvement magnétique du couvercle.
-  **DOSENÖFFNER.** Gerät aus einsatzgehartetem Stahl. Messer aus rostfreiem Stahl. Magnetische Deckelhebung.

**AV 4500** € 98,00

DIMENSIONI ESTERNE - EXTERNAL DIMENSIONS LxPxH cm  
 DIMENSIONS EXTERIEURES - AUßENABMESSUNGEN LxPxH cm

**10x23x69 h**

**AV 4585** € 18,00

**Gastronorm teak 53x32,5**

**AV 4586** € 19,00

**Euronorm teak 53x37**

**AV 4587** € 20,00

**Esagonale teak 52x34,5**

## Bilancia elettronica - Electronic scale Bilance électronique - Elektronische Waage

 BILANCIA ELETTRONICA KG 15 DIV. GR. 5. Corpo in materiale ABS. Piatto inox dim. 28x21. Alimentazione a batteria ricaricabile 230V 7W. Peso bilancia (batterie escluse) kg 4,1. Bolla di livello incorporata. Tastiera con protezione antispruzzo. Acquisizione tara. **Non adatta per la vendita al pubblico.**

 ELECTRONIC SCALE 15 KOS DIV. 5 GR. Body in ABS. Stainless steel plate 28x21 cm. Power supply 230V 7W with rechargeable batteries. Scale weight (batteries excluded) 4,1 kos. Incorporated level ball of air. Anti-sprinkling protection keyboard. **Tare acquisition. Not for retail sale.**



 BILANCE ÉLECTRONIQUE KG 15 DIV. GR 5. Corps en ABS. Plateau en acier inox 28x21 cm. Alimentation à batteries rechargeables 230V 7W. Poids de la balance (batteries exclues) 4,1 kg. Bulle de niveau incorporée. Clavier avec protection anti-éclaboussures. Acquisition de la tare. **Ce produit n'est pas destiné à la vente au détail.**

 ELEKTRONISCHE WAAGE 15 KG TRENN. GR 5. Gehäuse aus ABS. Waageschale aus rostfreier Stahl 28x21 cm. Speisung mit wiederaufladbare Batterien 230V 7W. Gewicht (ohne Batterien) 4,1 kg. Luftblase für das Niveau inbegriffen. Tastatur mit Spritzer-schutz. Taraerwerbung. **Nicht geeignet für den Einzelverkauf.**

**BL 4545**

**€ 250,00**

DIMENSIONI ESTERNE - EXTERNAL DIMENSIONS LxPxH cm

DIMENSIONS EXTERIEURES - AUBENABMESSUNGEN LxPxH cm

**29x33x22 h**



 BILANCIA ELETTRONICA KG 60 DIV. gr. 20. Piatto inox dim. 32x33. Display remoto cavo cm 150. Alimentazione a batteria + alimentatore 230V 2W. Peso bilancia (batterie escluse) kg 4,5. Acquisizione tara. **Non adatta per la vendita al pubblico.**

 ELECTRONIC SCALE 60 KOS DIV. 20 GR. Stainless steel plate 32x33 cm. Remote display with cable 150 cm. Power supply with battery + feeder 230V 2W. Scale weight (batteries excluded) 4,5 kos. **Tare acquisition. Not for retail sale.**

 BILANCE ÉLECTRONIQUE KG 60 DIV. GR 20. Plateau en acier inox 32x33 cm. Remote display avec cable cm 150. Alimentation avec batterie + alimentateur 230V 2W. Poids de la balance (batteries exclues) 4,5 kg. Acquisition de la tare. **Ce produit n'est pas destiné à la vente au détail.**

 ELEKTRONISCHE WAAGE 60 KG TRENN. GR 20. Waageschale aus rostfreier Stahl 32x33 cm. Remote display mit Kabel cm 150. Speisung mit Batterie + Speiseleistung 230V 2W. Taraerwerbung. **Nicht geeignet für den Einzelverkauf.**

**BP 4548**

**€ 190,00**

DIMENSIONI ESTERNE - EXTERNAL DIMENSIONS LxPxH cm

DIMENSIONS EXTERIEURES - AUBENABMESSUNGEN LxPxH cm

**31x30x5 h**

**Accessori per pizzeria - Accessories for pizzeria**  
**Accessoires pour pizzeria - Zubehör für Pizzerien**



Pala in alluminio forata professionale  
 Professional perforated aluminium paddle  
 Pale en aluminium percée professionnel  
 Lochschaufel aus Aluminium für professionellen Gebrauch

**AV 4960** € 132,00

DIMENSIONI ESTERNE - EXTERNAL DIMENSIONS LxPxH cm  
 DIMENSIONS EXTERIEURES - AUßENABMESSUNGEN LxPxH cm **33x33x170 h**

**AV 4961** € 148,00

DIMENSIONI ESTERNE - EXTERNAL DIMENSIONS LxPxH cm  
 DIMENSIONS EXTERIEURES - AUßENABMESSUNGEN LxPxH cm **36x36x170 h**

**AV 4962** € 173,00

DIMENSIONI ESTERNE - EXTERNAL DIMENSIONS LxPxH cm  
 DIMENSIONS EXTERIEURES - AUßENABMESSUNGEN LxPxH cm **45x45x170 h**

**AV 4963** € 182,00

DIMENSIONI ESTERNE - EXTERNAL DIMENSIONS LxPxH cm  
 DIMENSIONS EXTERIEURES - AUßENABMESSUNGEN LxPxH cm **50x50x170 h**



Pala in alluminio professionale  
 Professional aluminium paddle  
 Pale Alluminium professionnel  
 Schaufel aus Aluminium für professionellen Gebrauch

**AV 4926** € 118,00

DIMENSIONI ESTERNE - EXTERNAL DIMENSIONS LxPxH cm  
 DIMENSIONS EXTERIEURES - AUßENABMESSUNGEN LxPxH cm **33x33x170 h**

**AV 4927** € 132,00

DIMENSIONI ESTERNE - EXTERNAL DIMENSIONS LxPxH cm  
 DIMENSIONS EXTERIEURES - AUßENABMESSUNGEN LxPxH cm **36x36x170 h**

**AV 4930** € 158,00

DIMENSIONI ESTERNE - EXTERNAL DIMENSIONS LxPxH cm  
 DIMENSIONS EXTERIEURES - AUßENABMESSUNGEN LxPxH cm **45x45x170 h**

**AV 4930/50** € 165,00

DIMENSIONI ESTERNE - EXTERNAL DIMENSIONS LxPxH cm  
 DIMENSIONS EXTERIEURES - AUßENABMESSUNGEN LxPxH cm **50x50x170 h**



Pala in alluminio per forni elettrici e a gas  
 Aluminium paddle for electric and gas ovens  
 Pale aluminium pour fours électriques et à gas  
 Schaufel aus Aluminium für elektrische und Gasöfen

**AV 4965** € 44,00

DIMENSIONI ESTERNE - EXTERNAL DIMENSIONS LxPxH cm  
 DIMENSIONS EXTERIEURES - AUßENABMESSUNGEN LxPxH cm **33x35x70 h**



Pala in alluminio - Aluminium paddle  
 Pale Alluminium - Schaufel aus Aluminium

**AV 4925** € 75,00

DIMENSIONI ESTERNE - EXTERNAL DIMENSIONS LxPxH cm  
 DIMENSIONS EXTERIEURES - AUßENABMESSUNGEN LxPxH cm **33x33x135 h**

**AV 4928** € 90,00

DIMENSIONI ESTERNE - EXTERNAL DIMENSIONS LxPxH cm  
 DIMENSIONS EXTERIEURES - AUßENABMESSUNGEN LxPxH cm **33x33x170 h**

**AV 4929** € 96,00

DIMENSIONI ESTERNE - EXTERNAL DIMENSIONS LxPxH cm  
 DIMENSIONS EXTERIEURES - AUßENABMESSUNGEN LxPxH cm **36x36x170 h**



Palino in acciaio forato - Perforated steel small paddle  
 Petit pale pércées en acier - Kleine Lochschaufel aus Stahl

**AV 4922** € 90,00

DIMENSIONI ESTERNE - EXTERNAL DIMENSIONS LxPxH cm  
 DIMENSIONS EXTERIEURES - AUßENABMESSUNGEN LxPxH cm **Ø 18x170 h**

**AV 4923** € 95,00

DIMENSIONI ESTERNE - EXTERNAL DIMENSIONS LxPxH cm  
 DIMENSIONS EXTERIEURES - AUßENABMESSUNGEN LxPxH cm **Ø 22x170 h**

**AV 4968** € 100,00

DIMENSIONI ESTERNE - EXTERNAL DIMENSIONS LxPxH cm  
 DIMENSIONS EXTERIEURES - AUßENABMESSUNGEN LxPxH cm **Ø 26x170 h**



Palino in acciaio - Steel small paddle  
 Petit pale en acier - Kleine Schaufel aus Stahl

**AV 4920** € 82,00

DIMENSIONI ESTERNE - EXTERNAL DIMENSIONS LxPxH cm  
 DIMENSIONS EXTERIEURES - AUßENABMESSUNGEN LxPxH cm **Ø 18x170 h**

**AV 4921** € 86,00

DIMENSIONI ESTERNE - EXTERNAL DIMENSIONS LxPxH cm  
 DIMENSIONS EXTERIEURES - AUßENABMESSUNGEN LxPxH cm **Ø 22x170 h**



Paletta per cenere - Pan for Ash  
 Pelle à cendre - Aschenschaufel

**AV 4911** € 78,00

DIMENSIONI ESTERNE - EXTERNAL DIMENSIONS LxPxH cm  
 DIMENSIONS EXTERIEURES - AUßENABMESSUNGEN LxPxH cm **170 h**

**Accessori per pizzeria - Accessories for pizzeria**  
**Accessoires pour pizzeria - Zubehör für Pizzerien**



Kit 3 pezzi h.170 (pala ø33 - palino ø18 - spazzola)  
 Set of 3 pieces. h.170 (paddle ø33 - small paddle ø18 - brush)  
 Set de 3 pièces h.170 (pale ø33 - palette ø18 - brosse)  
 Set aus drei Stücke h.170 (Schaufel ø33 - kleine Schaufel ø18 - Bürste)

**AV 4970 € 188,00**

DIMENSIONI ESTERNE - EXTERNAL DIMENSIONS LxPxH cm **170 h**  
 DIMENSIONS EXTERIEURES - AUBENABMESSUNGEN LxPxH cm



Kit 3 pezzi h.135 (pala ø33 - palino ø22 - spazzola)  
 Set of 3 pieces. h.135 (paddle ø33 - small paddle ø22 - brush)  
 Set de 3 pièces h.135 (pale ø33 - petit pale ø22 - brosse)  
 Set aus drei Stücke h.135 (Schaufel ø33 - kleine Schaufel ø22 - Bürste)

**AV 4972 € 144,00**

DIMENSIONI ESTERNE - EXTERNAL DIMENSIONS LxPxH cm **135 h**  
 DIMENSIONS EXTERIEURES - AUBENABMESSUNGEN LxPxH cm



Pala per pizza metro  
 Paddle for meter pizza  
 Pale pour pizza au mètre  
 Schaufel für Meterpizza

**AV 4966 € 174,00**

DIMENSIONI ESTERNE - EXTERNAL DIMENSIONS LxPxH cm **60x40x170h**  
 DIMENSIONS EXTERIEURES - AUBENABMESSUNGEN LxPxH cm



Tagliere polietilene per pizza  
 Chopping board in polyethylene for pizza  
 Planches à hacher en polyethylene pour pizza  
 Hackbrette aus Polyäthlen

**AV 4935 € 45,00**

DIMENSIONI ESTERNE - EXTERNAL DIMENSIONS LxPxH cm **Ø 35**  
 DIMENSIONS EXTERIEURES - AUBENABMESSUNGEN LxPxH cm

**AV 4936 € 60,00**

DIMENSIONI ESTERNE - EXTERNAL DIMENSIONS LxPxH cm **Ø 40**  
 DIMENSIONS EXTERIEURES - AUBENABMESSUNGEN LxPxH cm



Spazzola ottone girevole a mezzaluna - Brass rotating brush, half-moon shaped  
 Brosse en laiton tournante, à demi-lune - Drehalmondbürste aus Messing

**AV 4959 € 100,00**

DIMENSIONI ESTERNE - EXTERNAL DIMENSIONS LxPxH cm **170 h**  
 DIMENSIONS EXTERIEURES - AUBENABMESSUNGEN LxPxH cm



Spazzola in fibra naturale - Brush in natural fibre  
 Brosse en fibrage naturelle - Bürste aus naturreim Faser

**AV 4912 € 68,00**

DIMENSIONI ESTERNE - EXTERNAL DIMENSIONS LxPxH cm **170 h**  
 DIMENSIONS EXTERIEURES - AUBENABMESSUNGEN LxPxH cm



Spazzola doppia inox/ottone con raschietto  
 Stainless steel/brass double brush with scraper  
 Double brosse inox/laiton avec grattoir  
 Doppelbürste Edelstahl/Messing mit Schaber

**AV 4971 € 46,00**

DIMENSIONI ESTERNE - EXTERNAL DIMENSIONS LxPxH cm **110 h**  
 DIMENSIONS EXTERIEURES - AUBENABMESSUNGEN LxPxH cm



Spazzola in ottone per forni a legna - Brass brush for wood-fired ovens  
 Brosse en laiton pour fours à bois - Bürste aus Messing für Holz Öfen

**AV 4919 € 86,00**

DIMENSIONI ESTERNE - EXTERNAL DIMENSIONS LxPxH cm **170 h**  
 DIMENSIONS EXTERIEURES - AUBENABMESSUNGEN LxPxH cm



Tagliere legno multistrato  
 Multilayer wood chopping board  
 Planche en bois multicouches  
 Hackbrette aus Multischichtholz

**AV 4776 € 39,00**

DIMENSIONI ESTERNE - EXTERNAL DIMENSIONS LxPxH cm **Ø 33**  
 DIMENSIONS EXTERIEURES - AUBENABMESSUNGEN LxPxH cm

**AV 4777 € 56,00**

DIMENSIONI ESTERNE - EXTERNAL DIMENSIONS LxPxH cm **Ø 45**  
 DIMENSIONS EXTERIEURES - AUBENABMESSUNGEN LxPxH cm

**Accessori per pizzeria - Accessories for pizzeria**  
**Accessoires pour pizzeria - Zubehör für Pizzerien**

Paletta servipizza in acciaio  
 Pan for pizzas serving  
 Palette pour le desservir de pizzas  
 Schaufel zur Bedienung von Pizza



**AV 4905** € 72,00

DIMENSIONI ESTERNE - EXTERNAL DIMENSIONS LxPxH cm  
 DIMENSIONS EXTERIEURES - AUßENABMESSUNGEN LxPxH cm **Ø 50 a 8 porzioni**

**AV 4931** € 46,00

DIMENSIONI ESTERNE - EXTERNAL DIMENSIONS LxPxH cm  
 DIMENSIONS EXTERIEURES - AUßENABMESSUNGEN LxPxH cm **Ø 33**

Retina tonda inox  
 Round little net in s/s  
 Résille ronde en acier inox  
 Rund Kleines Netz aus rostfreiem Stahl



**AV 4951** € 21,00

DIMENSIONI ESTERNE - EXTERNAL DIMENSIONS LxPxH cm  
 DIMENSIONS EXTERIEURES - AUßENABMESSUNGEN LxPxH cm **Ø 28**

**AV 4952** € 23,00

DIMENSIONI ESTERNE - EXTERNAL DIMENSIONS LxPxH cm  
 DIMENSIONS EXTERIEURES - AUßENABMESSUNGEN LxPxH cm **Ø 33**

**AV 4953** € 35,00

DIMENSIONI ESTERNE - EXTERNAL DIMENSIONS LxPxH cm  
 DIMENSIONS EXTERIEURES - AUßENABMESSUNGEN LxPxH cm **Ø 45**

Retina tonda alluminio  
 Round little net in aluminium  
 Résille ronde en alluminium  
 Round Kleines Netz aus Aluminium



**AV 4955** € 12,00

DIMENSIONI ESTERNE - EXTERNAL DIMENSIONS LxPxH cm  
 DIMENSIONS EXTERIEURES - AUßENABMESSUNGEN LxPxH cm **Ø 28**

**AV 4956** € 16,00

DIMENSIONI ESTERNE - EXTERNAL DIMENSIONS LxPxH cm  
 DIMENSIONS EXTERIEURES - AUßENABMESSUNGEN LxPxH cm **Ø 33**

**AV 4957** € 21,00

DIMENSIONI ESTERNE - EXTERNAL DIMENSIONS LxPxH cm  
 DIMENSIONS EXTERIEURES - AUßENABMESSUNGEN LxPxH cm **Ø 45**

Paletta inox per pizza triangolare 15x25 cm  
 Scoop in s/s for triangular pizza  
 Palette en acier inox pour pizza triangulaire  
 Stemple aus rostfreiem Stahl für dreieckige Pizza



**AV 4948** € 39,00

Paletta inox per pizza 10x15 cm  
 Stainless steel paddle for pizza 10x15 cm  
 Pale en acier inox pour pizza 10x15 cm  
 Schaufel aus Edelstahl für Pizza 10x15 cm



**AV 4954** € 23,00

Spatola in acciaio inox 10 cm  
 Scoop in s/s 10 cm  
 Raclette en acier inox 10 cm  
 Spachtel aus rostfreiem Stahl 10 cm



**AV 4932** € 14,00

Pinza prenditeglie  
 Plier for backin-tins  
 Pincés prend-plat  
 Zange zum Backform



**AV 4941** € 34,00

Bucasfoglia in lega  
 Pastry-perforating roller  
 Perce-abaisse  
 Ausgeroller Teig Lochgrädchen



**AV 4933** € 62,00

**Accessori per pizzeria - Accessories for pizzeria  
Accessoires pour pizzeria - Zubehör für Pizzerien**

Rotella taglia pizza Ø mm 90  
Pizza cutting wheel Ø mm 90  
Molette coupe pizza Ø mm 90  
Grädchen zur Pizza schneiden Ø mm 90



**AV 4934**

**€ 19,00**

Rotella professionale taglia pizza  
Ø mm 90  
Professional Pizza cutting wheel Ø mm 90  
Molette professionnelle coupe pizza Ø mm 90  
Grädchen für Pizza Ø mm 90



**AV 4949**

**€ 59,00**

Raschietto inox cm 12  
Brush in s/s cm 12  
Grattoir en acier inox cm 12  
Shaber aus rostfreiem Stahl cm 12



**AV 4946**

**€ 16,00**

Oliera in acciaio inox 0,75 lt.  
Cruet in s/s 0,75 lt.  
Huilier en acier inox 0,75 lt.  
Ölflasche aus rostfreiem Stahl 0,75 lt.



**AV 4942**

**€ 73,00**

Contenitore per impasti pizza  
Stackable pizza dough container  
Conteneur pour le gâchage  
de pizza  
Behälter für Pizza Teigmasse



**AV 4938**

**€ 13,00**

DIMENSIONI ESTERNE - EXTERNAL DIMENSIONS LxPxH cm  
DIMENSIONS EXTERIEURES - AUBENABMESSUNGEN LxPxH cm

**60x40x7,5 h**

**AV 4967**

**€ 15,00**

DIMENSIONI ESTERNE - EXTERNAL DIMENSIONS LxPxH cm  
DIMENSIONS EXTERIEURES - AUBENABMESSUNGEN LxPxH cm

**60x40x9 h**

**AV 4939** Coperchio per contenitore / Container lid.

**€ 11,00**

DIMENSIONI ESTERNE - EXTERNAL DIMENSIONS LxPxH cm  
DIMENSIONS EXTERIEURES - AUBENABMESSUNGEN LxPxH cm

**60x40**

Cassetta per appoggio pale  
Box holding paddles  
Cassette pour pales  
Schaufelkiste



**AV 4916**

**€ 59,00**

Supporto reggipale a muro  
Wall holding paddle  
Support palettes à mur  
Wandschaufelträger



**AV 4913**

**€ 34,00**

Supporto reggipale a muro  
Wall holding paddle  
Support palettes à mur  
Wandschaufelträger



**AV 4914**

**€ 50,00**

Supporto reggipale  
Paddle support  
Support pour pales  
Schaufelträger



**AV 4910**

**€ 250,00**

DIMENSIONI ESTERNE - EXTERNAL DIMENSIONS LxPxH cm  
DIMENSIONS EXTERIEURES - AUBENABMESSUNGEN LxPxH cm

**150 h**

Alare per appoggio legna  
Andiron stand for firewood  
Chenet pour appui bois  
Alare als Holzstütze



**AV 4918**

**€ 64,00**



Borsa termica 5 pizze Ø33 per consegna a domicilio  
Thermal bag 5 pizzas Ø33 for take-away  
Borse calorifique pour 5 pizza Ø33 à apporter  
Wärme Behälter zum Mitnehmen Ø33

**AV 4975**

**€ 52,00**

DIMENSIONI ESTERNE - EXTERNAL DIMENSIONS LxPxH cm  
DIMENSIONS EXTERIEURES - AUßENABMESSUNGEN LxPxH cm

**37x37x20**



Piastra di fissaggio al portapacchi ciclomotore (per art. AV4973)  
Fixing plate for motorbike package shelf (for item AV4973)  
Plaque de montage pour porte-bagages du cyclomoteur (pour article AV4973)  
Befestigungsplatte für Gepäckträger des Motorrads (für Artikel AV4973)

**AV 4974**

**€ 68,00**

DIMENSIONI ESTERNE - EXTERNAL DIMENSIONS LxPxH cm  
DIMENSIONS EXTERIEURES - AUßENABMESSUNGEN LxPxH cm

**35x37x6,5**



Portapizze rigido, interno in alluminio, per trasporto 10 pizze Ø33  
Box thermal bag holder for transport of 10 pizzas Ø33  
Conteneur porte.sac thermique pour le transport de 10 pizza Ø33  
Behälter mit wärmer Tasche um 10 Pizza Ø33 zu tragen

**AV 4973**

**€ 270,00**

DIMENSIONI ESTERNE - EXTERNAL DIMENSIONS LxPxH cm  
DIMENSIONS EXTERIEURES - AUßENABMESSUNGEN LxPxH cm

**47x47x52**







***Ceppi***   
***Copriceppo***  
***Taglieri***  
***Accessori per macelleria***

***Chopping Block***   
***Chopping Block Cover***  
***Chopping boards***  
***Butchery accessories***

***Souche***   
***Couvre Souche***  
***Planches à hacher***  
***Accessoires pour boucherie***

***Hackklotz***   
***Hackklotzdecke***  
***Hackbrette***  
***Metzgereibetriebe***

## Ceppi, taglieri e accessori - Chopping blocks, chopping boards and accessories Sabots, planches à hacher et accessoires - Hackov, Schneidebretter und Zubehör

-  Ceppo in legno di acacia. Trattato con vernice atossica e collanti ecologici (conformi alle norme vigenti) assemblato con innesti a pressione e internamente con inserti speciali in legno. Batticarne ecologico e riciclabile - Reversibile.
-  Acacia chopping-block treated with antitoxic paint and ecologic glues (in compliance with regulations) pressure clutch assembling. Special inside wooden insertions - Ecologic and recyclable meat-pounder - Reversible.
-  Sabot en bois d'acacia traité avec des vernis atoxiques et colles écologiques (conformément aux règlements en vigueur). Assemblé par embrayage à pression en à l'intérieur par l'introduction de pièces en bois. Battoir à viande recyclable et écologique. Reversible.
-  Hackov aus Akazienholz, ungiftiger Lach und ökologischer Kleber (den geltenden Normen entsperchend) mit auf Druck ansteckbaren Zusatz und mit speziellen, internen Holzeinlagen. Fleischklöpfer, ökologisch, recycle, und umkehrbar.



SPESSORE / THICKNESS 17 cm

|                 |                             |                 |
|-----------------|-----------------------------|-----------------|
| <b>CCL 1744</b> | Ceppo + Sgabello 40x40x90 h | <b>€ 400,00</b> |
| <b>CCL 1745</b> | Ceppo + Sgabello 45x45x90 h | <b>€ 450,00</b> |
| <b>CCL 1755</b> | Ceppo + Sgabello 50x50x90 h | <b>€ 530,00</b> |
| <b>CCL 1764</b> | Ceppo + Sgabello 60x40x90 h | <b>€ 530,00</b> |
| <b>CCL 1766</b> | Ceppo + Sgabello 60x60x90 h | <b>€ 700,00</b> |
| <b>CCL 1774</b> | Ceppo + Sgabello 70x40x90 h | <b>€ 585,00</b> |
| <b>CCL 1775</b> | Ceppo + Sgabello 70x50x90 h | <b>€ 700,00</b> |



SPESSORE / THICKNESS 25 cm

|                 |                             |                 |
|-----------------|-----------------------------|-----------------|
| <b>CCL 2544</b> | Ceppo + Sgabello 40x40x90 h | <b>€ 505,00</b> |
| <b>CCL 2555</b> | Ceppo + Sgabello 50x50x90 h | <b>€ 660,00</b> |
| <b>CCL 2564</b> | Ceppo + Sgabello 60x40x90 h | <b>€ 660,00</b> |
| <b>CCL 2566</b> | Ceppo + Sgabello 60x60x90 h | <b>€ 810,00</b> |
| <b>CCL 2574</b> | Ceppo + Sgabello 70x40x90 h | <b>€ 700,00</b> |
| <b>CCL 2575</b> | Ceppo + Sgabello 70x50x90 h | <b>€ 810,00</b> |
| <b>CCL 2577</b> | Ceppo + Sgabello 70x70x90 h | <b>€ 960,00</b> |







SPESSORE / THICKNESS 35 cm

|                 |                             |                   |
|-----------------|-----------------------------|-------------------|
| <b>CCL 3555</b> | Ceppo + Sgabello 50x50x90 h | <b>€ 810,00</b>   |
| <b>CCL 3566</b> | Ceppo + Sgabello 60x60x90 h | <b>€ 1.000,00</b> |
| <b>CCL 3575</b> | Ceppo + Sgabello 70x50x90 h | <b>€ 1.000,00</b> |
| <b>CCL 3577</b> | Ceppo + Sgabello 70x70x90 h | <b>€ 1.250,00</b> |
| <b>CCL 3586</b> | Ceppo + Sgabello 80x60x90 h | <b>€ 1.250,00</b> |





**Per ceppi, sgabelli o misure speciali, richiedere preventivo**  
**For chopping blocks, supports or special dimensions, please ask for a quotation**  
**Pour billots, escabeaux ou dimensions spéciales, veuillez nous demander un devis**  
**Für Hackklötze, Hocker oder besondere Abmessungen, bitte um einen Voranschlag ansuchen**

## Ceppi, taglieri e accessori - Chopping blocks, chopping boards and accessories Sabots, planches à hacher et accessoires - Hackov, Schneidebretter und Zubehör

-  CEPPINO IN POLIETILENE 80 h mm CON SGABELLO IN TUBOLARE ACCIAIO INOX 500x500x800 h mm
-  POLYETHYLENE CHOPPING BLOCK 80 h mm WITH TUBULAR STAINLESS STEEL FRAME 500x500x800 h mm
-  SABOTS DE POLYTHÈNE 80 h mm AVEC CHASSIS EN TUBULAIRE EN ACIER INOXYDABLE 500x500x800 h mm
-  HACKKLOTZ AUS POLYÄTHYLEN 80 h mm MIT RAHMEN AUS ROSTFREIEM STAHL 500x500x800 h mm



|                 |                                 |                 |
|-----------------|---------------------------------|-----------------|
| <b>CCP 8000</b> | Ceppo + Sgabello 400x400x880 h  | <b>€ 340,00</b> |
| <b>CCP 8001</b> | Ceppo + Sgabello 500x500x880 h  | <b>€ 435,00</b> |
| <b>CCP 8002</b> | Ceppo + Sgabello 700x500x880 h  | <b>€ 530,00</b> |
| <b>CCP 8003</b> | Ceppo + Sgabello 600x600x880 h  | <b>€ 510,00</b> |
| <b>CCP 8004</b> | Ceppo + Sgabello 700x700x880 h  | <b>€ 620,00</b> |
| <b>CCP 8005</b> | Ceppo + Sgabello 800x600x880 h  | <b>€ 610,00</b> |
| <b>CCP 8006</b> | Ceppo + Sgabello 1000x500x880 h | <b>€ 630,00</b> |

-  COPRICEPPO DI POLIETILENE BIANCO
-  CHOPPING BLOCK COVER IN POLYETHYLENE WHITE
-  COUVRE SOUCHE EN POLYTHÈNE BLANC
-  HACKKLOTZDECKE AUS POLYÄTHYLEN WEISS

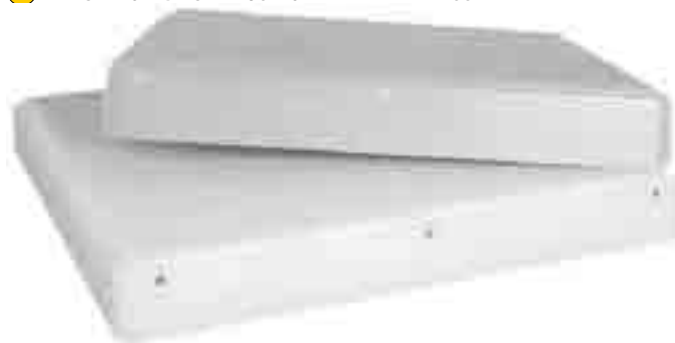

|                 |              |                 |
|-----------------|--------------|-----------------|
| <b>KCP 2501</b> | 400x400x25 h | <b>€ 75,00</b>  |
| <b>KCP 2502</b> | 500x500x25 h | <b>€ 100,00</b> |
| <b>KCP 2503</b> | 600x400x25 h | <b>€ 95,00</b>  |
| <b>KCP 2504</b> | 600x600x25 h | <b>€ 125,00</b> |
| <b>KCP 2505</b> | 700x400x25 h | <b>€ 110,00</b> |
| <b>KCP 2506</b> | 700x500x25 h | <b>€ 130,00</b> |
| <b>KCP 2508</b> | 700x700x25 h | <b>€ 160,00</b> |





-  CEPPINO IN POLIETILENE ALIMENTARE BIANCO 80 h mm
-  WHITE POLYETHYLENE CHOPPING BLOCKS FOR FOOD 80 h mm



|                   |                        |                 |
|-------------------|------------------------|-----------------|
| <b>CPE 40408</b>  | Ceppo PE 400x400x80 h  | <b>€ 150,00</b> |
| <b>CPE 50508</b>  | Ceppo PE 500x500x80 h  | <b>€ 230,00</b> |
| <b>CPE 70508</b>  | Ceppo PE 700x500x80 h  | <b>€ 310,00</b> |
| <b>CPE 60608</b>  | Ceppo PE 600x600x80 h  | <b>€ 290,00</b> |
| <b>CPE 70708</b>  | Ceppo PE 700x700x80 h  | <b>€ 390,00</b> |
| <b>CPE 80608</b>  | Ceppo PE 800x600x80 h  | <b>€ 380,00</b> |
| <b>CPE 100508</b> | Ceppo PE 1000x500x80 h | <b>€ 390,00</b> |

**Per sgabelli di ricambio richiedere preventivo**  
**For spare supports, please ask for a quotation**  
**Pour escabeaux de rechange, veuillez nous demander un devis**  
**Für Ersatzhocker, bitte um einen Voranschlag ansuchen**

## Ceppi, taglieri e accessori - Chopping blocks, chopping boards and accessories Sabots, planches à hacher et accessoires - Hackov, Schneidebretter und Zubehör

-  TAGLIERI IN POLIETILENE
-  POLYETHYLENE CHOPPING BOARDS
-  PLANCHES À HACHER EN POLYTHÉNE
-  HACKBRETTE AUS POLYÄTHYLEN



|                 |   |                |
|-----------------|---|----------------|
| <b>TP 40302</b> | 40x30x2 h bianco/white  | <b>€ 25,00</b> |
| <b>TP 50302</b> | 50x30x2 h bianco/white  | <b>€ 29,00</b> |
| <b>TP 50402</b> | 50x40x2 h bianco/white  | <b>€ 39,00</b> |
| <b>TP 60402</b> | 60x40x2 h bianco/white  | <b>€ 47,00</b> |
| <b>TP 70402</b> | 70x40x2 h bianco/white  | <b>€ 55,00</b> |
| <b>TP 80402</b> | 80x40x2 h bianco/white  | <b>€ 61,00</b> |
| <b>TP 50302</b> | 50x30x2 h<br>colorato: giallo, blu, marrone, rosso verde<br>coloured: yellow, blue, brown, red, green | <b>€ 31,00</b> |
| <b>TP 60402</b> | 60x40x2 h<br>colorato: giallo, blu, marrone, rosso verde<br>coloured: yellow, blue, brown, red, green | <b>€ 50,00</b> |

Per scelta colore aggiungere al codice:

To choose the colour add to the code:

Pour choisir la couleur ajouter au code:

Für Farbwahl am Kode hinzufügen

**Y = Giallo / Yellow / Jaune / Gelb**

**M = Marrone / Brown / Marron / Braun**

**G = Verde / Green / Vert / Grün**

**B = Blu / Blue / Bleu / Blau**

**R = Rosso / Red / Rouge / Rot**

-  RASCHIETTO
-  BRUSH
-  BROSSE
-  REINIGUNGSBÜRSTE



|              |  |                |
|--------------|--|----------------|
| <b>RASK</b>  | Raschietto per pulizia ceppi e taglieri - Brush for chopping blocks and chopping boards cleaning | <b>€ 30,00</b> |
| <b>RICRA</b> | Ricambio lama per raschietto<br>Blade spare part for the brush                                   | <b>€ 14,00</b> |



***Sterilizzatori elettrici***   
***Accessori antinfortunistici***  
***Lavamani***  
***Scaffalatura modulare***  
***Elettroinsetticidi a lampade UV-A***



***Electric sterilizers***   
***Safety accessories***  
***Wash basins***  
***Modular shelving***  
***Ultraviolet ray bug lamp***

***Stérilisateurs électriques***   
***Accessoires de protection***  
***Lave-mains***  
***Rayonnage modulaire***  
***Insecticide électrique à lampes UV-A***

***Elektrische Sterilisatoren***   
***Unfallschutz-Zubehör***  
***Handwaschbecken***  
***Bausteinregale***  
***UV-A-Lampen-Insektenfänger***

## Sterilizzatori elettrici - Electric sterilizers Stérilisateurs électriques - Elektrische Sterilisatoren

-  Armadietto sterilizzatore a raggi UV costruito in acciaio inox Scotch Brite. Portina in plexiglas trasparente con microinterruttore. Portacoltelli in acciaio inox. Funzionamento con lampada germicida a UV 230 V 50/60 Hz 16W con griglia di protezione. Temporizzatore 60' e lampada spia di funzionamento. Cavo con spina.
-  UV sterilizer cupboard built in stainless steel scotch brite polished. Door in transparent perspex with safety microswitch. Germicide lamp UV 230 V 50/60 Hz 16W. Stainless steel knife holder with protection grid. Timer 60' with signal lamp. Cable with plug.

-  Armoire de sterilization UV en acier inox poli scotch brite. Porte en plexiglas transparent avec microinterrupteur de sécurité. Porte-couteaux en acier. Fonctionnement avec lampe germicide à UV 230 V 50/60 Hz 16W avec grille de protection. Minuterie 60' et lampe témoin. Cable avec prise.
-  Sterilizer Schrank UV aus Edelstahl. Tür ist aus durchsichtigen Plexiglas gebaut mit Mikroschalter. Messerhalter aus Edelstahl. Funktiostüchtigkeit mit Ultraviolettlampe 230 V 50/60 Hz 16W nackte-rientöntend und Sicherheitroste. Timer 60' mit Kontrollleuchte. Kabel mit Stecker.



Capacità 14 coltelli - Capacity 14 knives  
Capacité 14 couteaux - Tragfähigkeit 14 Messer

**SUV 14**

**€ 270,00**

DIMENSIONI ESTERNE - EXTERNAL DIMENSIONS LxPxH cm  
DIMENSIONS EXTERIEURES - AUßENABMESSUNGEN LxPxH cm

**54x16x64 h**



Capacità 10 coltelli - Capacity 10 knives  
Capacité 10 couteaux - Tragfähigkeit 10 Messer





**SUV 10**

**€ 250,00**

DIMENSIONI ESTERNE - EXTERNAL DIMENSIONS LxPxH cm  
DIMENSIONS EXTERIEURES - AUßENABMESSUNGEN LxPxH cm

**43x16x64 h**

## **Sterilizzatori elettrici e Antinfortunistica - Electric sterilizers and Safety** **Stérilisateur électriques et Protection - Elektrische Sterilisatoren und Unfallschutz**

-  Sterilizzatori elettrici per coltelli. Struttura in acciaio inox 230 V 50/60Hz - Watt 1500. Termostato regolabile interno 30-110°C. Rubinetto di carico e scarico.
-  Electric knife sterilizers. Structure in stainless steel, 230 V 50/60 Hz - 1500 W, adjustable internal thermostat 30-110°C. Water loading un loading tap.
-  Stérilisateur électriques pour couteaux. Structure en acier inox 230 V 50/60 Hz - 1500 W. Thermostat interne réglable 30-110°C. Robinet d'introduction et dechargement d'eau.
-  Elektrische Sterilisatoren für Messer. Struktur aus Niro-Stahl. V 230 50/60 Hz - Watt 1500. Einstellbarer Innenthermostat für 30-110°C. Hahn zum Einleiten und entladen des Wassers.







Capacità 12 coltelli - Capacity 12 knives  
Capacité 12 couteaux - Tragfähigkeit 12 Messer

**SN 38** **€ 320,00**

DIMENSIONI ESTERNE - EXTERNAL DIMENSIONS LxPxH cm  
DIMENSIONS EXTERIEURES - AUßENABMESSUNGEN LxPxH cm

**38x14x40 h**

-  Accessori antinfortunistici per macelleria.
-  Safety accessories for Butcheries.
-  Accessoires de protection pour la boucherie.
-  Unfallschutz-Zubehör für Metzgereibetriebe.



- 1) Grembiule alluminio antinfortunistico con bretelle  
Aluminium safety apron with braces  
Tablier aluminium de protection à bretelles  
Unfallschutzkittel aus Aluminium mit Hosenträgern

**AV 4897** **€ 150,00**

- 2) Grembiule acciaio inox antinfortunistico con bretelle  
Stainless steel safety apron with braces  
Tablier de protection acier inox à bretelles  
Unfallschutzkittel aus Inox-Stahl mit Hosenträgern

**AV 4898** **€ 180,00**

- 3) Avambraccio antinfortunistico in plexiglass misura standard  
Standard size Plexiglas forearm protection  
Avant-bras de protection en plexiglas taille standard  
Unterarmschutz aus Plexiglas, Standardgröße

**AV 4899** **€ 40,00**

- 4) Guanto inox antinfortunistico a cinque dita con cinturino inox completamente sterilizzabile  
Completely cleansable stainless steel five fingered safety glove with stainless steel strap  
Gant inox de protection à cinq doigts inox complètement stérilisable  
Fünffinger-Schutzhandschuh mit Inox-Riemen, vollkommen sterilisierbar.

**AV 4900** **€ 150,00**

- 5) Guanto inox antinfortunistico a cinque dita con chiusura a molla inox. Avambraccio compreso  
Stainless steel five fingered safety glove with stainless steel spring strap. Forearm protection included  
Gant inox de protection à cinq doigts avec fermeture à ressort inox. Avant-bras compris  
Fünffinger-Schutzhandschuh mit Inox-Feder-Verschluss, einschließlich Unterarm.

**AV 4901** **€ 270,00**

## Lavamani - Wash basins

### Lave-mains - Handwaschbecken

- 🇮🇹 Combinato lavamani più lava stracci inox con rubinetto acqua calda/fredda.
- 🇬🇧 Stainless steel combined hands and rags wash basin and with hot/cold water tap.
- 🇫🇷 Lave-mains et lave-chiffons en acier inox avec robinet eau chaude/froide.
- 🇩🇪 Gekoppeltes Handwasch- und Lumpenbecken aus Edelstahl mit Kalt- und Warmwasserhahn.



**LMMC**

**€ 500,00**

DIMENSIONI ESTERNE - EXTERNAL DIMENSIONS LxPxH cm  
DIMENSIONS EXTERIEURES - AUßENABMESSUNGEN LxPxH cm

**70x50x89 h**

- 🇮🇹 Lavamani inox su mobile con porte a battente, comando a "ginocchio".
- 🇬🇧 Stainless steel wash basins with stand and pivot doors. Knee control.
- 🇫🇷 Lave-mains inox sur meuble avec portes battantes. Contrôle à genou.
- 🇩🇪 Handwaschbecken aus Inox mit Stand und Türen. Kniebefehl.



**LMM**

**€ 450,00**

DIMENSIONI ESTERNE - EXTERNAL DIMENSIONS LxPxH cm  
DIMENSIONS EXTERIEURES - AUßENABMESSUNGEN LxPxH cm

**50x40x85 h**

- 🇮🇹 Lavamani - lavautensili inox su mobile con porta a battente. Con miscelatore acqua calda/fredda vasca da mm. 400x400x250
- 🇬🇧 Stainless steel hand and tools wash basin with stand and pivot doors. With hot/cold mixer tap - 400x400x250mm basin
- 🇫🇷 Lave-mains et lave-outils inox sur meuble avec portes battantes. Avec robinet mélangeur eau chaude/froide - lavabo 400x400x250mm
- 🇩🇪 Hand- und Küchengerätewaschbecken aus Inox mit Stand und Drehflügeltür. Mit Kalt- und Warmwassermischhahn - Becken 400x400x250mm



**LC 50 MM**

**€ 550,00**

DIMENSIONI ESTERNE - EXTERNAL DIMENSIONS LxPxH cm  
DIMENSIONS EXTERIEURES - AUßENABMESSUNGEN LxPxH cm

**50x50x85 h**

- 🇮🇹 Lavamani inox su mobile con porte a battente, comando a "ginocchio".
- 🇬🇧 Stainless steel wash basins with stand and pivot doors. Knee control.
- 🇫🇷 Lave-mains inox sur meuble avec portes battantes. Contrôle à genou.
- 🇩🇪 Handwaschbecken aus Inox mit Stand und Türen. Kniebefehl.

**NEW**

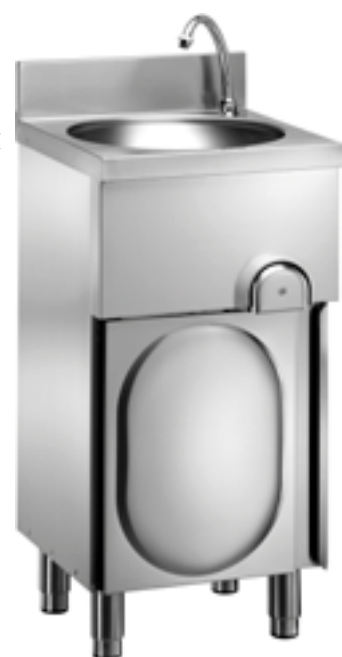

**LM 48 M**





**€ 420,00**

DIMENSIONI ESTERNE - EXTERNAL DIMENSIONS LxPxH cm  
DIMENSIONS EXTERIEURES - AUßENABMESSUNGEN LxPxH cm

**40x40x85 h**



## Lavamani - Wash basins Lave-mains - Handwaschbecken

-  Lavamani inox a colonna comando a "ginocchio".
-  Stainless steel wash basin column with pedal control "knee".
-  Lave-mains inox à colonne à commande à pédale "Genou".
-  Handwaschbecken aus Inox zur Befestigung an der Wand, "Knie"-Bedienungs pedal.







**LC 50**

**€ 330,00**

DIMENSIONI ESTERNE - EXTERNAL DIMENSIONS LxPxH cm  
DIMENSIONS EXTERIEURES - AUßENABMESSUNGEN LxPxH cm

**50x40x80 h**

-  Lavamani inox a parete comando a "ginocchio".
-  Stainless steel wash basin column with pedal control "knee".
-  Lave-mains inox à fixation mural avec commande à pédale "Genou".
-  Handwaschbecken aus Inox zur Befestigung an der Wand, "Knie"-Bedienungs pedal.







**LM 48**

**€ 310,00**

DIMENSIONI ESTERNE - EXTERNAL DIMENSIONS LxPxH cm  
DIMENSIONS EXTERIEURES - AUßENABMESSUNGEN LxPxH cm

**48x35x53 h**



-  Lavamani inox a parete comando a "ginocchio".
-  Stainless steel wash basin column with pedal control "knee".
-  Lave-mains inox à fixation mural avec commande à pédale "Genou".
-  Handwaschbecken aus Inox zur Befestigung an der Wand, "Knie"-Bedienungs pedal.

**LM 40**

**€ 230,00**

DIMENSIONI ESTERNE - EXTERNAL DIMENSIONS LxPxH cm  
DIMENSIONS EXTERIEURES - AUßENABMESSUNGEN LxPxH cm

**40x40x32 h**

## Scaffalatura modulare - Modular shelving

### Rayonnage modulaire - Bausteinregale

La scaffalatura modulare nella versione in alluminio anodizzato rappresenta la soluzione ideale per l'immagazzinaggio nel rispetto delle norme d'igiene. L'ampia scelta di misure standard assicura una grande adattabilità ed un notevole risparmio di spazio. DESIGN RISPONDENTE ALLE NORME IGIENICHE. Le superfici lisce ed arrotondate, i profili chiusi, la totale assenza di spazi o fessure dove possa annidarsi lo sporco, permettono il mantenimento di un elevato standard di igiene. QUALITÀ DELLE LEGHE. La scaffalatura modulare per poter resistere all'usura prodotta da agenti chimici, termici e meccanici, è stata realizzata con leghe di alta qualità. A seconda delle specifiche esigenze, può essere richiesta nella versione di alluminio anodizzato (20 micron). Gli scaffali sono stati progettati per sopportare un alto carico con il minimo di flessione. UN SISTEMA PER TUTTI GLI USI. Le aree applicative della scaffalatura modulare sono molte: dal catering alle grandi cucine, dagli ospedali agli alberghi, dalle celle frigorifere ai magazzini in genere. Il sistema, per la sua grande versatilità, organizza e salva lo spazio in ogni ambiente. consentendo anche l'uso delle vaschette serie gastronorm (1/2 - 1/1 - 2/1 - 2/3) perfettamente inserite all'interno dei ripiani.

Ripiani in alluminio completi di griglie in polietilene  
composti da: N° 2 fiancate, N° 4 attacchi, serie griglie.

Aluminum shelves equipped with polyethylene shelves  
made up by: n° 2 longitudinal section bars, n° 4 joints, grid series.

Etagères en aluminium avec grilles en polyéthylène  
munis de: n° 2 longerons, n° 4 attaches, série grilles.

Vollständige Aluminiumauflagen mit Polyäthylenrosten  
bestehend aus: n° 2 Seitenverbindungen, n° 4 Anschlüssen, Serie Roste.

Either you choose the anodized aluminium version or the stainless steel version, modular shelving will always be the ideal solution for storage purposes in conformity the required hygiene rules. A wide choice of standard size components ensures great flexibility and space optimization. DESIGN CONFORMING TO HYGIENE RULES. Smooth surfaces, rounded-off corners, completely sealed units, total absence of gaps or crevices which could harbor organic matters ensure the maintenance of high hygiene standards in the long run. HIGH QUALITY ALLOYS. Modular shelving is exclusively manufactured from highquality alloys which make the shelving resistant to wear due the chemical agents, heat and mechanical stress. Depending on your needs, you can choose between the anodized aluminum version (20 microns) or the stainless steel version (AISI 304). The shelves have been so designed and constructed as to bear heavy loads with minimum bending. A SYSTEM FOR ALL USE. The application areas of the modular shelving are various: from catering to the big kitchens, from hospitals to hotels, from cold stores to general stores. This system, for its great versatility, organizes and saves space in each room, allowing the use of the gastronorm containers (1/2 1/1 2/1 2/3) properly fitted into the shelves.



Giunzioni per angolo - Angle clamps  
Joints pour angle - Eckverbindungen

|   |                |
|---|----------------|
| <b>GA 373</b>   | <b>€ 20,00</b> |
| DIMENSIONI ESTERNE - EXTERNAL DIMENSIONS mm<br>DIMENSIONS EXTERIEURES - AUßENABMESSUNGEN mm | <b>373</b>     |

Testata completa con: n. 2 piantane, n. 3 traversini, n. 2 piedi, n. 2 tappi.  
End side equipped with: n. 2 pedestals, n. 3 sleepers, n. 2 feet, n. 2 plugs.  
Echelle munie de: n. 2 montants, n. 3 traverses, n. 2 pieds, n. 2 bouchons.  
Vollständiges Seitenteil mit: n. 2 Streben, n. 3 Querteiler, n. 2 Füße, n. 2 Stopfen.

|   |                  |
|---|------------------|
| <b>F 15</b>   | <b>€ 76,00</b>   |
| DIMENSIONI ESTERNE - EXTERNAL DIMENSIONS mm<br>DIMENSIONS EXTERIEURES - AUßENABMESSUNGEN mm | <b>373x1550h</b> |

|   |                  |
|---|------------------|
| <b>F 17</b>   | <b>€ 76,00</b>   |
| DIMENSIONI ESTERNE - EXTERNAL DIMENSIONS mm<br>DIMENSIONS EXTERIEURES - AUßENABMESSUNGEN mm | <b>373x1700h</b> |

|   |                  |
|---|------------------|
| <b>F 20</b>   | <b>€ 84,00</b>   |
| DIMENSIONI ESTERNE - EXTERNAL DIMENSIONS mm<br>DIMENSIONS EXTERIEURES - AUßENABMESSUNGEN mm | <b>373x2000h</b> |

|   |                 |
|---|-----------------|
| <b>R 62</b>   | <b>€ 45,00</b>  |
| DIMENSIONI ESTERNE - EXTERNAL DIMENSIONS mm<br>DIMENSIONS EXTERIEURES - AUßENABMESSUNGEN mm | <b>373x620</b>  |
| <b>R 88</b>   | <b>€ 54,00</b>  |
| DIMENSIONI ESTERNE - EXTERNAL DIMENSIONS mm<br>DIMENSIONS EXTERIEURES - AUßENABMESSUNGEN mm | <b>373x886</b>  |
| <b>R 97</b>   | <b>€ 57,00</b>  |
| DIMENSIONI ESTERNE - EXTERNAL DIMENSIONS mm<br>DIMENSIONS EXTERIEURES - AUßENABMESSUNGEN mm | <b>373x974</b>  |
| <b>R 106</b>  | <b>€ 60,00</b>  |
| DIMENSIONI ESTERNE - EXTERNAL DIMENSIONS mm<br>DIMENSIONS EXTERIEURES - AUßENABMESSUNGEN mm | <b>373x1062</b> |
| <b>R 115</b>  | <b>€ 65,00</b>  |
| DIMENSIONI ESTERNE - EXTERNAL DIMENSIONS mm<br>DIMENSIONS EXTERIEURES - AUßENABMESSUNGEN mm | <b>373x1152</b> |
| <b>R 124</b>  | <b>€ 68,00</b>  |
| DIMENSIONI ESTERNE - EXTERNAL DIMENSIONS mm<br>DIMENSIONS EXTERIEURES - AUßENABMESSUNGEN mm | <b>373x1240</b> |
| <b>R 133</b>  | <b>€ 78,00</b>  |
| DIMENSIONI ESTERNE - EXTERNAL DIMENSIONS mm<br>DIMENSIONS EXTERIEURES - AUßENABMESSUNGEN mm | <b>373x1330</b> |
| <b>R 150</b>  | <b>€ 79,00</b>  |
| DIMENSIONI ESTERNE - EXTERNAL DIMENSIONS mm<br>DIMENSIONS EXTERIEURES - AUßENABMESSUNGEN mm | <b>373x1505</b> |

## **Elettroinsetticidi a lampade UV-A - Ultraviolet ray bug lamp** **Insecticide électrique à lampes UV-A - UV-A-Lampen-Insektenfänger**

 Materiale alluminio. Potenza 30W. Lampade 2x15W. montaggio: orizzontale o verticale. Copertura 80 mq. Collante di ricambio CRS30.

 Material Aluminium. Power 30W. Lamps 2x15W. Assembling: horizontal or vertical. Coverage 80 mq. Extra adhesive paper CRS30.



**SE30**

**€ 200,00**

DIMENSIONI ESTERNE - EXTERNAL DIMENSIONS LxPxH cm  
DIMENSIONS EXTERIEURES - AUßENABMESSUNGEN LxPxH cm

**30x13x55 h**

 Materiale inox. Potenza 30W. Lampade 2x15W. Montaggio sospesa/muro. Copertura 80mq. Collante di ricambio CR30.

 Stainless steel. Light output 30W. Tubes 2x15W. 3 ways mounting. Coverage 80smq. Glue board replacement CR30.

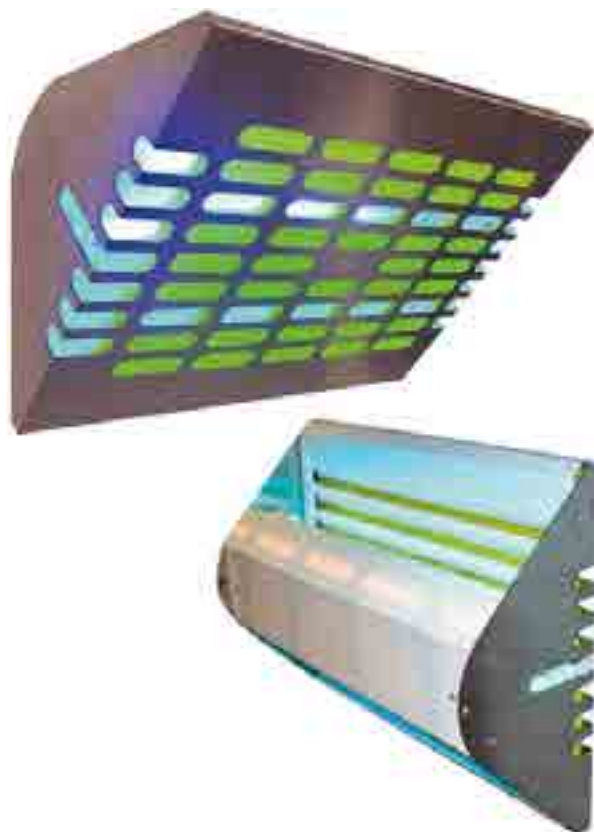



**FT30**

**€ 210,00**

DIMENSIONI ESTERNE - EXTERNAL DIMENSIONS LxPxH cm  
DIMENSIONS EXTERIEURES - AUßENABMESSUNGEN LxPxH cm

**47x19x36 h**

 Materiale alluminio. Potenza 30W. Lampade 2x15W. Montaggio: a muro, ad angolo o appoggiato. Copertura

 Material Aluminium. Power 30W. Lamps 2x15W. Assembling: to the wall, in a corner or in support. Coverage 80 mq.



**PZ30**

**€ 100,00**

DIMENSIONI ESTERNE - EXTERNAL DIMENSIONS LxPxH cm  
DIMENSIONS EXTERIEURES - AUßENABMESSUNGEN LxPxH cm

**52x13x26 h**

## Ricambi - Spare parts

|               |   |                |
|---------------|---|----------------|
| <b>A 42</b>   | Spazzola ricambio in fibra naturale per AV4912  | <b>€ 18,00</b> |
| <b>A 43</b>   | Spazzola ricambio in ottone per AV4919          | <b>€ 21,00</b> |
| <b>A 45</b>   | Ricambio spazzolone ottone mezzaluna            | <b>€ 28,00</b> |
| <b>A 414</b>  | Barattolo lt. 1 lucido neutro per lucidascarpe  | <b>€ 20,00</b> |
| <b>A 520</b>  | Sacco in tela ignifugo per carrelli             | <b>€ 60,00</b> |
| <b>A 540</b>  | Ricambio MOP in cotone da gr. 400               | <b>€ 9,00</b>  |
| <b>A 550</b>  | Pinza plastica gigante per MOP                  | <b>€ 7,00</b>  |
| <b>A 560</b>  | Manico legno verniciato Ø 24 - cm 150           | <b>€ 8,00</b>  |
| <b>A 570</b>  | Strizzatore plastica con ingranaggi in plastica | <b>€ 72,00</b> |
| <b>R 4501</b> | Lama ricambio per apriscatole AV4500            | <b>€ 12,00</b> |
| <b>R 4502</b> | Ingranaggio ricambio per apriscatole AV4500     | <b>€ 20,00</b> |
| <b>CR 30</b>  | Carta collante per FT 30 (confezione 6 pezzi)   | <b>€ 45,00</b> |
| <b>L 616</b>  | Lampada 15W per FT 30 / SE30                    | <b>€ 10,00</b> |
| <b>L 617</b>  | Lampada 15W per PZ 30                           | <b>€ 10,00</b> |
| <b>CRS30</b>  | Carta collante per SE30 (confezione 6 pezzi)    | <b>€ 34,00</b> |





## CONDIZIONI GENERALI DI VENDITA

- **COSTO DELL'IMBALLO:** compreso nel prezzo per le macchine - ricambi ed accessori € 5,00.
- **PER ORDINI DI IMPORTO INFERIORE A € 80,00 COSTO FISSO GESTIONE ORDINI € 5,00.**
- **CONDIZIONI DI PAGAMENTO:** Si richiede il pagamento in contanti o in contrassegno: 1. per le prime forniture - 2. al superamento del fido - 3. per l'invio dei ricambi.
- **DILAZIONI DI PAGAMENTO:** da definire.
- **PREZZI:** non sono impegnativi, possono subire variazioni senza obbligo di preavviso, in tal caso saranno confermati all'ordine. **I PREZZI SONO ESCLUSI DI I.V.A.**
- **TERMINI DI CONSEGNA:** 1. spedizione giornaliera per macchine disponibili a magazzino - 2. per macchine da produrre circa 25 giorni salvo imprevisti.
- **ASSISTENZA TECNICA:** a carico del **RIVENDITORE** per tutta la durata della garanzia di anni uno. Forcar srl si impegna a fornire, in garanzia, tutti i componenti di ricambio ritenuti difettosi. Il prezzo di vendita fatturato all'utilizzatore finale comprenderà non solo il prezzo dei prodotti finiti venduti ma anche la gestione, da parte del rivenditore, della garanzia a copertura di essi. Forcar srl non dovrà sostenere alcuna spesa diretta o indiretta sostenuta dal rivenditore per la gestione della garanzia.
- **TRASPORTO FRANCO FABBRICA;** la merce viaggia a rischio e pericolo del committente, per cui non siamo responsabili per eventuali danni subiti dalla merce durante il trasporto. Eventuali contestazioni dovranno essere effettuate all'atto della consegna entro i termini di legge.
- **GARANZIA:** 12 mesi.
- **LISTINO:** il presente annulla tutti i precedenti. I dati tecnici e immagini riportati nel presente listino sono puramente indicativi. La Ditta si riserva il diritto di modificare le caratteristiche tecniche ed estetiche o sospendere, in ogni momento, la propria produzione senza obbligo di preavviso.
- **TUTTE LE NOSTRE MACCHINE SONO COPERTE DA ASSICURAZIONE (RESPONSABILITÀ CIVILE VERSO TERZI) ESCLUSO U.S.A. E CANADA**
- MOD089V03 - FINITO DI STAMPARE NEL SETTEMBRE 2015



## GENERAL CONDITIONS OF SALE

- **COST OF PACKING:** included in price for machines. € 5,00 for spare parts and accessories.
- **FIXED HANDLING FEE OF € 5,00 FOR ORDERS OF LESS THAN € 80,00.**
- **CONDITIONS OF PAYMENT:** Cash payment or on delivery: 1. for first orders - 2. for orders in excess of granted credit - 3. for shipment of spare parts.
- **DEFERRED PAYMENTS:** to define.
- **PRICES** are not binding. They can be subjected to changes without prior advise. In anycase they will be defined by the order confirmation. **PRICES DO NOT INCLUDE VAT**
- **DELIVERY TIME:** 1. daily after receipt of orders for machines already available - 2. about 25 working days after receipt of orders for machines to be produced, subject to absence of unforeseen difficulties.
- **TECHNICAL ASSISTANCE:** provided by the **DEALER** for the entire duration of the **GUARANTEE**, (1 year). Forcar srl undertakes to provide, under warranty, all replacement parts considered defective. The sale price invoiced to the end user will include not only the price of the finished products sold, but also the management, by the dealer, of the warranty that covers them. Forcar srl will not incur any direct or indirect expenses incurred by the dealer for warranty management.
- **DELIVERY EX WORKS.** We are not responsible for any damage the goods can suffer during the transport: the goods are carried at the customer's own risk. Any eventual complaint must be reported within law terms.
- **WARRANTY:** 12 months.
- **PRICE LIST:** this price-list replaces all previous lists. The technical data and pictures illustrated in this price-list are only approximate. The manufacturer reserves the right to change technical and visual characteristics and to suspend production at any time without giving prior notice.
- **ALL OUR MACHINE ARE COVERED BY THE THIRD PARTY PRODUCT LIABILITY INSURANCE (U.S.A. AND CANADA EXCLUDED)**
- MOD089V03 - PRINTING COMPLETED IN SEPTEMBER 2015



## CONDITIONS GENERALES DE VENTE

- **COÛT DE L'EMBALLAGE:** compris dans le prix pour les machines. € 5,00 pour les pièces de rechange et les accessoires.
- **POUR TOUTES COMMANDES INFÉRIEURES À € 80,00 COÛT FIXE DE GESTION DES COMMANDES DE € 5,00**
- **CONDITIONS DE PAIEMENT** - le paiement doit être effectué en argent comptant ou contre remboursement: 1. pour les premières fournitures - 2. au dépassement du crédit accordé - 3. pour l'envoi de pièces de rechange.
- **ECHEANCE DE PAIEMENT:** à définir.
- **PRIX:** ne sont pas définitifs, ils peuvent subir des variations sans obligation de préavis. Dans ce cas ils seront confirmés au moment de la commande. **LES PRIX NE COMPRENNENT PAS LA TVA**
- **DELAI DE LIVRAISON** 1. livraison journalière pour les machines disponibles - 2. alors que pour les machines à produire, à environ 25 jours ouvrables, sauf imprévis.
- **ASSISTANCE TECHNIQUE:** a la charge du **REVENDEUR** pour toute la durée de la **GARANTIE** (Une année). La société Forcar srl s'engage à fournir, en garantie, tous les composants de rechange considérés défectueux. Le prix de vente facturé à l'utilisateur final inclura le prix des produits finis vendus mais également la gestion, de la part du revendeur, de la garantie pour la couverture de ceux-ci. La société Forcar srl ne devra soutenir aucune dépense directe ou indirecte soutenue par le revendeur pour la gestion de la garantie.
- **TRANSPORT DEPART-USINE.** La marchandise voyage a risques et périls du client. La maison n'est pas responsable des éventuels dommages subis par la marchandise pendant le transport. Les éventuelles réclamations doivent être communiquées dans les délais de la loi.
- **GARANTIE:** 12 mois.
- **LISTE DES PRIX:** la présente liste annule tous les précédents. Les données techniques contenues dans la présente liste des prix et les photos sont purement indicatives. La maison se réserve le droit de modifier les caractéristiques techniques et esthétiques de ses articles ou d'en interrompre la production, à tout moment et sans obligation de préavis.
- **TOUTES NOS MACHINES SONT COUVERTES PAR UNE ASSURANCE (RESPONSABILITÉ CIVILE ENVERS TIERS)**
- MOD089V03 - ACHEVÉ D'IMPRIMER EN SEPTEMBRE 2015



## ALLGEMEINE VERKAUFSBEDINGUNGEN

- **VERPACKUNGSKOSTEN:** im preis der maschinen inbegriffen. € 5,00 für ersatzteile und zubehöre.
- **FÜR BESTELLUNGEN UNTER € 80,00**
- **FIXE BEARBEITUNGS- GEBÜHR € 5,00.**
- **ZAHLUNGSBEDINGUNGEN** - Direktzahlung oder Zahlung bei Wareneingang wird verlangt: 1. für die erste lieferungen - 2. bei Überschreitung des gewährten Kredits - 3. für die Sendung von Ersatzteilen.
- **ZAHLUNGSZIEL:** Um zu bestimmen.
- **PREISE:** nicht verbindlich sind und können geändert sein ohne die Pflicht im Voraus zu benachrichtigen; in diesen Fall werden mit der Auftragbestätigung bestätigt sein. **DIE PREISE VERSTEHEN SICH AUSSCHLIESSLICH MWST LIEFERFRIST** 1. Täglich für verfügbare Maschinen - 2. für Maschinen um zu produzieren ungefähr 25 Arbeitstage, unvorhergesehene Umstände vorbehalten.
- **TECHNISCHER DIENST:** Zu lasten des **WIEDERVERKÄUFERS** während der gesamten Dauer der **GARANTIE** (1 Jahr). Forcar srl verpflichtet sich, während der Garantiezeit, zur Lieferung aller für defekt befundenen Ersatzteile. Der dem Endverbraucher in Rechnung gestellte Verkaufspreis umfasst nicht nur den Preis für die verkauften Endprodukte, sondern auch die Kosten für die Verwaltung der Garantie durch den Verkäufer. Forcar srl werden keine zusätzlichen direkten oder indirekten Kosten, die dem Verkäufer für die Verwaltung der Garantie entstehen, in Rechnung gestellt.
- **TRANSPORT FREI UNSEREM WERK.** Die Ware ist auf Gefahr der Auftraggeber transportiert, deshalb sind wir nicht verantwortlich für eventuelle Schaden der Ware während der Transport zugefügt. Eventuelle Anfechtungen sollen unbedingt nur nach den Gesetz gemacht sein.
- **GARANTIE:** 12 monate.
- **PREISLISTE:** Die vorliegende Preisliste setzt alle vorhergehenden außer Kraft. Die in der vorliegenden Preisliste angegebenen technischen Daten und die Fotos sind reine Richtwerte. Die Firma behält sich das Recht vor, die technischen oder ästhetischen Eigenschaften zu verändern oder die Produktion ohne Vorankündigung jederzeit einzustellen.
- **ALLE UNSERE MASCHINEN SIND VERSICHERUNGSGEDECKT (HAFTPFLICHT)**
- MOD089V03 - FERTIG GEDRUCKT IM SEPTEMBER 2015



## CONDICIONES GENERALES DE VENTA

- **COSTE DEL EMBALAJE:** incluido en el precio para las máquinas - repuestos y accesorios 5,00 €
- **PARA PEDIDOS CON UN IMPORTE INFERIOR A 80,00 € COSTE FIJO GESTIÓN PEDIDOS 5,00 €**
- **CONDICIONES DE PAGO:** Se exige el pago en efectivo o contra reembolso: 1. para los primeros suministros - 2. cuando se supere el crédito - 3. para el envío de los repuestos.
- **APLAZAMIENTO DE PAGOS:** pendiente de definición.
- **PRECIOS:** no son vinculantes; pueden sufrir variaciones sin que la empresa esté obligada a avisar de ello previamente. En dicho caso, se confirmarán en el momento del pedido. **LOS PRECIOS NO INCLUYEN IVA.**
- **PLAZOS DE ENTREGA:** 1. envío diario para máquinas disponibles en el almacén - 2. 25 días aproximadamente, salvo imprevistos, para máquinas que deban fabricarse.
- **ASISTENCIA TÉCNICA:** A cargo del distribuidor durante todo el periodo de garantía (concretamente, 1 año). Forcar srl se compromete a suministrar, en garantía, todos los componentes de repuesto considerados defectuosos. El precio de venta facturado al usuario final incluirá no solo el precio de los productos acabados vendido, sino también la gestión, por parte del distribuidor, de la garantía que los cubre. Forcar srl no asumirá ningún gasto directo o indirecto soportado por el distribuidor por la gestión de la garantía.
- **TRANSPORTE FRANCO FÁBRICA:** la mercancía viaja por cuenta y riesgo del cliente; por tanto, no asumimos ninguna responsabilidad por los posibles daños que pueda sufrir la mercancía durante el transporte. Las reclamaciones deberán realizarse en el momento de la entrega y siempre respetando los términos legales.
- **GARANTÍA:** 12 meses
- **CATÁLOGO:** el presente catálogo anula todos los anteriores. Los datos técnicos y fotos incluidos en este catálogo son puramente indicativos. La Empresa se reserva el derecho a modificar las características técnicas y estéticas, o a suspender, en cualquier momento, su producción sin estar obligada a avisar previamente.
- **TODAS NUESTRAS MÁQUINAS ESTÁN CUBIERTAS POR SEGURO (RESPONSABILIDAD CIVIL Y DAÑOS A TERCEROS)**
- MOD089V03 - ACABADO DE IMPRIMIR EN SEPTIEMBRE DE 2015



## CONDIÇÕES GERAIS DE VENDA

- **CUSTO DA EMBALAGEM:** incluido no preço de máquinas - peças e acessórios € 5,00.
- **PARA ENCOMENDAS COM VALOR INFERIOR A € 80,00, CUSTO FIXO DE GESTÃO DA ENCOMENDA € 5,00.**
- **CONDIÇÕES DE PAGAMENTO:** É solicitado o pagamento em dinheiro ou contra entrega: 1. para as primeiras entregas - 2. ao superar o crédito - 3. para o envio de peças de reposição.
- **DIFERIMENTOS DE PAGAMENTO:** a definir.
- **PREÇOS:** não são vinculantes, podem sofrer alterações sem obrigação de aviso prévio; nestes casos, serão confirmados com a encomenda. **OS PREÇOS SÃO INDICADOS SEM I.V.A.**
- **PRAZOS DE ENTREGA:** 1. expedição diária para máquinas disponíveis em estoque. 2. para máquinas a produzir, cerca de 25 dias, salvo imprevistos.
- **ASSISTÊNCIA TÉCNICA:** A cargo do revendedor durante toda a duração da garantia de um ano. A Forcar srl empenha-se em fornecer, sob garantia, todos os componentes de reposição considerados defeituosos. O preço de venda cobrado ao utilizador final compreenderá não apenas o preço dos produtos acabados vendidos, mas também a gestão, por parte do revendedor, da garantia de cobertura dos produtos. A Forcar srl não deverá arcar com nenhuma despesa, direta ou indireta, mantida pelo revendedor para a gestão da garantia.
- **TRANSPORTE FRANCO FÁBRICA:** a mercadoria viaja a risco e perigo do comitente, portanto não somos responsáveis por eventuais danos à mercadoria provocados durante o transporte. Quaisquer queixas deverão ser feitas no momento da entrega, dentro dos prazos legais.
- **GARANTIA:** 12 meses.
- **LISTA DE PREÇOS:** Esta lista anula toda as anteriores. Os dados técnicos indicados nesta lista são meramente indicativos. A Empresa reserva-se o direito de modificar as características técnicas e estéticas ou suspender, a qualquer momento, a sua produção sem obrigação de aviso prévio.
- **TODAS AS NOSSAS MÁQUINAS SÃO COBERTAS POR SEGURO (RESPONSABILIDADE CIVIL PERANTE TERCEIROS)**
- MOD089V03 - IMPRESSO EM SETEMBRO 2015



## ОБЩИЕ УСЛОВИЯ ПРОДАЖИ

- **СТОИМОСТЬ УПАКОВКИ:** входит в цену для машин, запчастей и комплектующих € 5,00.
- **ДЛЯ ЗАКАЗОВ СТОИМОСТЬЮ МЕНЬШЕ € 80,00 ФИКСИРОВАННАЯ СТОИМОСТЬ ОБРАБОТКИ ЗАКАЗА € 5,00.**
- **УСЛОВИЯ ОПЛАТЫ:** требуется оплата наличными или наложенным платежом: 1. для первых поставок - 2. при превышении кредита - 3. для отправки запчастей.
- **ОТСРОЧКА ПЛАТЕЖА:** уточнить.
- **ЦЕНЫ:** не являются обязательными, могут меняться без обязательства уведомления, в данном случае будут подтверждены при оформлении заказа. **ЦЕНЫ УКАЗАНЫ БЕЗ НДС.**
- **УСЛОВИЯ ПОСТАВКИ:** 1. ежедневная отгрузка машин, имеющихся на складе - 2. в случае необходимости производства машины, 25 дней за исключением непредвиденных обстоятельств.
- **ТЕХНИЧЕСКАЯ ПОДДЕРЖКА:** За счёт дилера на время действия гарантии в течение одного года. Компания Forcar srl обязуется поставить, на условиях гарантии, все запасные компоненты, признанные дефектными. Фактурированная цена продажи конечному пользователю будет включать в себя не только цену готовой продукции, но также предоставление со стороны дилера гарантии. Forcar srl не примет на себя никакие расходы, прямые или косвенные, понесенные дилером на предоставление и выполнение условий гарантии.
- **ТРАНСПОРТИРОВКА ФРАНКО-ЗАВОД:** заказчик обязуется организовать должным образом перевозку товаров, поэтому мы не несем ответственности за любой ущерб, понесенный товаром во время транспортировки. Любые претензии должны быть предъявлены по факту поставки в срок, предусмотренный законодательством.
- **ГАРАНТИЯ:** 12 месяцев
- **ПЕРЕЧЕНЬ:** настоящий отменяет все предыдущие. Технические данные, приведенные в настоящем перечне, являются ориентировочными. Фирма оставляет за собой право изменять технические и эстетические характеристики или прервать производство в любой момент без обязательства уведомления.
- **ВСЕ НАШИ МАШИНЫ ПОКРЫТЫ ГАРАНТИЕЙ (ГРАЖДАНСКАЯ ОТВЕТСТВЕННОСТЬ ПЕРЕД ТРЕТЬИМИ ЛИЦАМИ)**
- MOD089V03 - ОТПЕЧАТАНО В СЕНТЯБРЕ 2015.



## طورش عربلا قماعلا

- **تكلفة التغليف:** من ضمن السعر للماكينة - قطع الغيار والملحقات 5 يورو.
- **للطلبات التي لا تتجاوز سعر 80 يورو، التكلفة الثابتة لإدارة الطلبات هي 5 يورو.**
- **شروط الدفع:** يُطلب الدفع نقداً أو عند التسليم: 1. لمرات التوريد الأولى - 2. عند تجاوز رصيد القيد على الحساب - 3. لإرسال قطع الغيار.
- **الدفع بالتقسيط:** يجب تحديده.
- **الأسعار:** الأسعار ليست إجبارية أو ثابتة، يمكن أن تخضع للتعديلات ودون سابق إنذار، في هذه الحالات سيتم تحديدها عند الطلب. الأسعار لا تشمل قيمة الضريبة المضافة (I.V.A.).
- **مواعيد التسليم:** 1. شحن يومي للماكينات المتوفرة في المخزن - 2. 25 يوم للماكينات التي يجب إنتاجها باستثناء الظروف الطارئة.
- **الدعم الفني:** يتحمل البائع طوال فترة الضمان البالغة عام واحد. تلتزم فيمار (شركة مساهمة) Forcar srl بموجب الضمان بتوريد جميع مكونات قطع الغيار التي يثبت أنها معطوبة. سعر البيع الموضح في الفاتورة إلى المستخدم النهائي لا يتضمن فقط سعر المنتجات النهائية المباعة ولكنه يتضمن أيضاً إدارة الضمان الذي يغطي هذه المنتجات من جانب البائع. لن تتحمل فيمار (شركة مساهمة) Forcar srl أية تكلفة مباشرة أو غير مباشرة يتكبدها البائع مقابل إدارته للضمان.
- **التسليم في أرض المصنع:** تسافر البضاعة على مسؤولية وخطر طالبيها، لذلك لا تتحمل أية مسؤولية عن الأضرار التي تصيب البضاعة أثناء النقل. أية شكاوى أو اعتراضات يجب تقديمها عند استلام البضاعة وبموجب القوانين.
- **الضمان:** 12 شهر.
- **القائمة:** تلغي هذه القائمة جميع القوائم السابقة. البيانات الفنية المدونة في هذه القائمة هي إرشادية فقط. تحتفظ الشركة بحقها في تعديل المواصفات الفنية والجمالية أو إيقاف الإنتاج في أي وقت دون ضرورة إعطاء إي إنذار سابق.
- **جميع ماكيناتنا مؤمنة (المسئولية المدنية نحو أطراف ثالثة)**
- **ي من أ MOD089V03 عابطلا يف ريمتبس 2015**

FOOD PROCESSING EQUIPMENT  
MULTISERVICE TROLLEYS  
REFRIGERATED LINE  
SNACK BAR EQUIPMENT

fimar  
group

# Noi ci mettiamo il

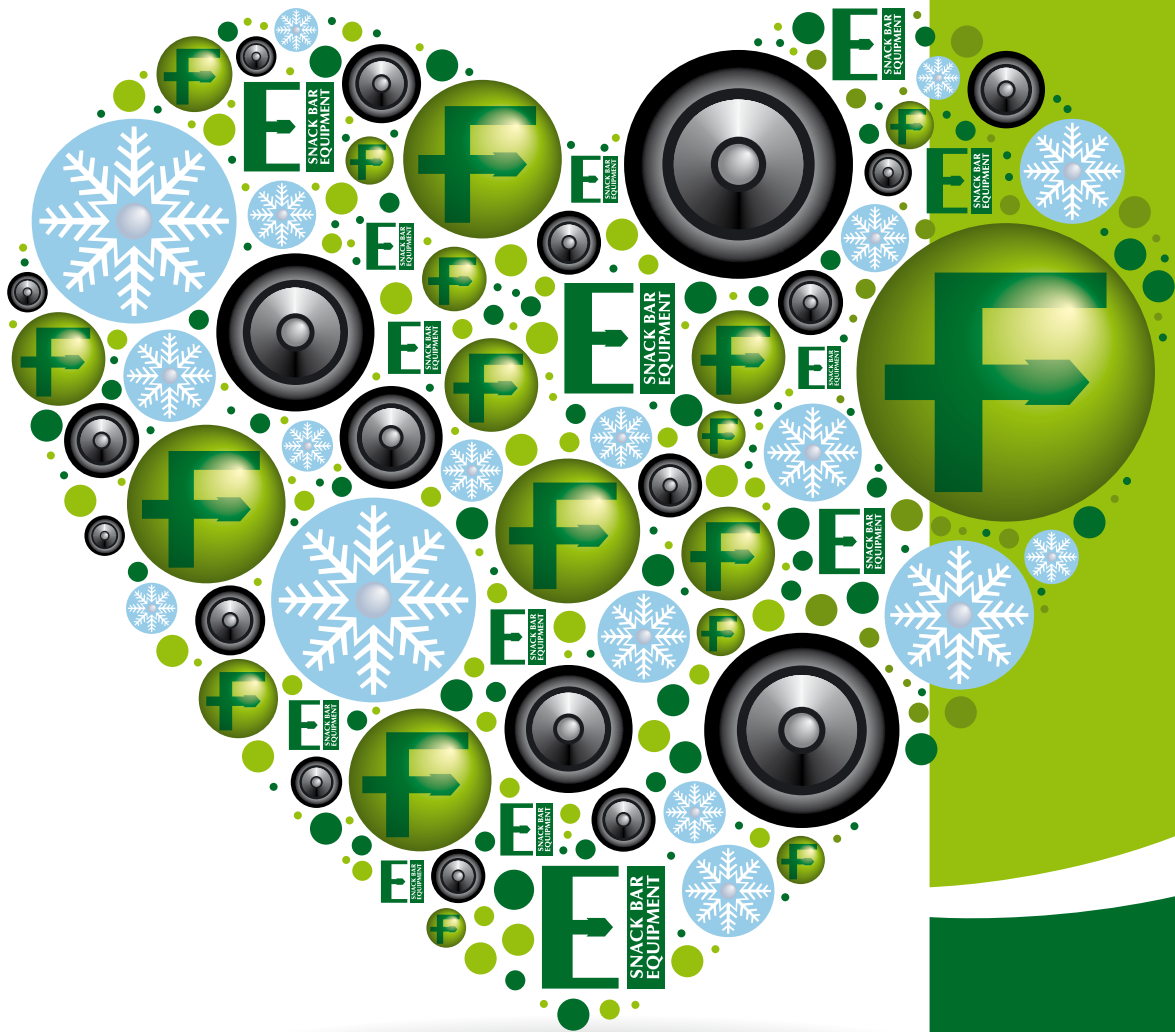

# forcar®

Via S. Pertini, 14 - 47826 Villa Verucchio (RN) ITALY - [www.forcar.it](http://www.forcar.it)  
Tel. +39 0541 670529 - Fax +39 0541 670064 - e.mail: [mail@forcar.it](mailto:mail@forcar.it)

